

depuis 1927

# WEMAS

G 20

 ROUES - ROULETTES

 RÄDER - ROLLEN

 RUOTE - ROTELLE



WEMAS sàrl | GRAND-RUE 73-75 | CH-2720 TRAMELAN

Tél. +41 032 487 43 28 | Fax +41 032 487 44 43 | [www.wemas.ch](http://www.wemas.ch)



## Le chemin des ROULETTES

C'est avec plaisir que nous vous présentons notre nouveau catalogue. Vous trouverez un grand choix dans notre programme de **Roues, Roulettes, Supports, Poulies, Galets de portes, Roulements à billes, Billes porteuses, en Acier Inoxydable ou Zingué, Roue en Caoutchouc, Polyuréthane, Antistatique, Polyamide, Nylon, Pneumatique, Fonte, etc...**

Pour chaque usage et pour toutes les exigences. Nous tenons en permanence un stock important, afin de pouvoir satisfaire l'ensemble de vos commandes dans un délai immédiat.

**Commerce, Industrie, Hôpital, Collectivité, Bureau, Magasin, Ecole, Alimentation, Hôtel, Privé, etc...** Vous avez des besoins spécifiques, nous sommes à votre entière disposition pour répondre à vos différentes demandes, même pour les petites quantités.

Les différents matériaux composant nos roues et roulettes, les fabricants ainsi que les distributeurs sont tous certifiés ISO 9001, ce qui nous permet de vous offrir uniquement des articles de qualité.

**Besoin d'information ou de conseil, contactez-nous !**

## Der Weg zu ROLLEN

*Es freut uns Ihnen den neuen Katalog zu präsentieren. Wir geben Ihnen einen Ueberblick über unser reichhaltiges Programm an Räder, Rollen, Gehäuse, Kugellager, Seirollen, Schiebetorrollen, Kugelrollen, aus Stahl verzinkt oder Rostfrei, Rad aus Gummi, Polyurethan, Antistatisch, Polyamid, Nylon, Reifen, Guss, usw...*

*Für jeden Zweck und für alle Ansprüche. Wir führen ständig ein grosses Lager, damit wir alle Ihre Bestellungen termingerecht erfüllen können.*

*Betrieb, Industrie, Spital, Gemeinschaft, Büro, Laden, Schule, Lebensmittel, Hotel, Privat, usw... Haben Sie besondere Wünsche, stehen wir Ihnen voll und ganz zur Verfügung für verschiedene Anfragen, selbst für kleine Mengen.*

*Unser grosses Sortiment an Rollen und Rädern setzt sich zusammen nur aus qualitativ hochwertigen und aus bestem Material gefertigten Produkten verschiedener, namhafter Hersteller und Lieferanten, die sich der ISO-Norm 9001 verpflichten.*

**Kontaktieren Sie uns, wenn Sie Informationen oder Beratung benötigen !**

## Il percorso delle ROTELLE

*È con piacere che vi presentiamo il nostro nuovo catalogo. Troverete una grande scelta di Ruote, Rotelle, Supporti, Pulegge, Rulli di porte, Cuscinetto a sfere, Rulli sferici, in Acciaio zincato o Inox, Ruota in Gomma, Poliuretano, Anstistatico, Poliammide, Nylon, Pneumatiche, Ghisa, ecc...*

*Per ogni impiego e per tutte le esigenze. Teniamo in modo permanente uno scorto importante per potere soddisfare tutte le vostre ordinazioni entro un termine immediato.*

*Commercio, Industria, Ospedale, Collettività, Ufficio, Negozio, Scuola, Albergo, Alimentazione, Privato, ecc... Avete bisogni specifici o non trovate ciò di cui avete bisogno, noi siamo a vostra intera disposizione per rispondere alle vostre varie richieste, anche per le piccole quantità.*

*I materiali diversi che compongono le nostre ruote e rotelle, i fabbricanti e i distributori sono ogni ISO 9001 munito di certificato, ciò che ci permette di offrirvi solamente articoli di qualità.*

**Per informazioni o consigli, contattateci !**



### Des spécialistes pour vous servir

Wemas vous offre un service et des conseils professionnels pour répondre à vos besoins et à vos demandes spécifiques dans toute la Suisse et dans votre langue

### Spezialisten, die Sie unterstützen

Wemas bietet Ihnen professionellen Service und Beratung, um Ihre spezifischen Bedürfnisse und Anforderungen in der ganzen Schweiz und in Ihrer Sprache zu erfüllen

### Specialisti per supportarvi

Wemas vi offre un servizio e una consulenza professionali per soddisfare le vostre esigenze e richieste specifiche in tutta la Svizzera e nella vostra lingua



### Des délais qui font plaisir

Grâce à notre bonne gestion du stock et notre flexibilité en matière de service à la clientèle, nous sommes en mesure de répondre rapidement à vos demandes

### Fristen, die glücklich machen

Dank unserer guten Lagerverwaltung und unserer Flexibilität im Kundenservice können wir schnell auf Ihre Anfragen reagieren

### Tempi che vi rendono felici

Grazie alla nostra buona gestione delle scorte e alla nostra flessibilità nel servizio alla clientela, siamo in grado di rispondere rapidamente alle vostre richieste



(<https://www.wemas.ch>)



### Des solutions à des prix attractifs

En quelques clics, par e-mail ou par téléphone, vous accédez à nos produits, à nos services et trouvez rapidement la solution à votre besoin à des prix très compétitifs

### Lösungen zu attraktiven Preisen

Mit wenigen Klicks, per E-Mail oder Telefon können Sie auf unsere Produkte und Dienstleistungen zugreifen und schnell die Lösung für Ihre Anforderungen zu sehr günstigen Preisen finden

### Soluzioni a prezzi interessanti

In pochi click, tramite e-mail o telefono, potete accedere ai nostri prodotti e servizi e trovare velocemente la soluzione alle vostre esigenze a prezzi molto competitivi



### Un partenaire fiable

Depuis 1927, Wemas est votre partenaire fiable sur qui vous pouvez compter en tout temps et en toutes saisons

### Ein zuverlässiger Partner

Seit 1927 ist Wemas Ihr zuverlässiger Partner, auf den Sie sich jederzeit und zu jeder Jahreszeit verlassen können

### Un partner affidabile

Dal 1927, Wemas è il vostro partner affidabile su cui contare in qualsiasi momento e in qualsiasi stagione





## INFORMATIONS TECHNIQUES

## TECHNISCHE INFORMATIONEN

## INFORMAZIONI TECNICI

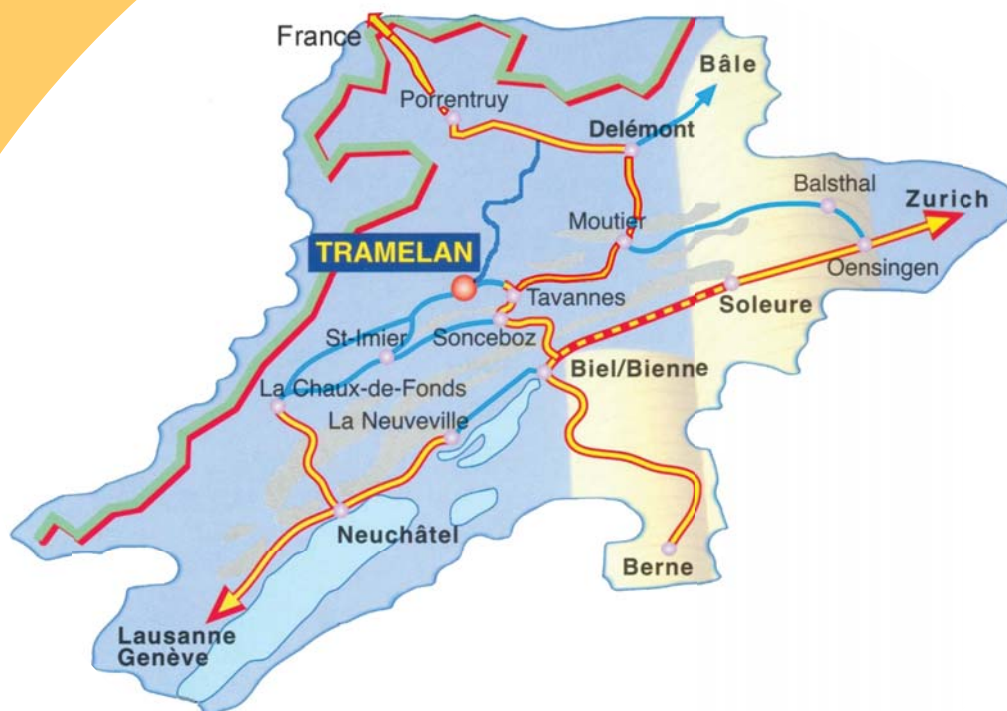

### INDEX / INHALT / INDICE



**PAGE 1.1**  
SOMMAIRE 1-4  
INHALT 1-4  
INDICE 1-4



**PAGE 1.2**  
SOMMAIRE 5-8  
INHALT 5-8  
INDICE 5-8



**PAGE 1.3**  
BON COMMANDE  
BESTELLSCHEINI  
FORMA-ORDINE



**PAGE 1.4**  
ARTICLE-PAGE  
ARTIKEL-SEITE  
ARTICOLO-PAGA



**PAGE 1.5**  
SYMBOLE  
SYMBOL  
SIMBOLOGIA



**PAGE 1.6**  
ROULEMENT  
RADLAGERUNG  
CUSCINETTO



**PAGE 1.7**  
CHOIX DE ROUE  
AUSWHL-RAD  
SCELTA RUOTA



**PAGE 1.8**  
SUPPORT 2-3-H  
GEHAUSE 2-3-H  
SUPPORTI 2-3-H



**PAGE 1.9**  
SUPPORT 5-7-8  
GEHAUSE 5-7-8  
SUPPORTI 5-7-8



**PAGE 1.10**  
SUPPORT 6-TL-34  
GEHAUSE 6-TL-34  
SUPPORTI 6-TL-3



**PAGE 1.11**  
SUPPORT 9-TH  
GEHAUSE 9-TH  
SUPPORTI 9-TH



**PAGE 1.11**  
SUPPORT 9-TH  
GEHAUSE 9-TH  
SUPPORTI 9-TH

### SECTEURS / BEREICHE / SETTORI





**SOMMAIRE**

**INHALT**

**INDICE**

**INDEX**

**INFORMATIONS TECHNIQUES**

1.0 - 1.11



**TECHNISCHE INFORMATIONEN**

**INFORMAZIONI TECNICI**

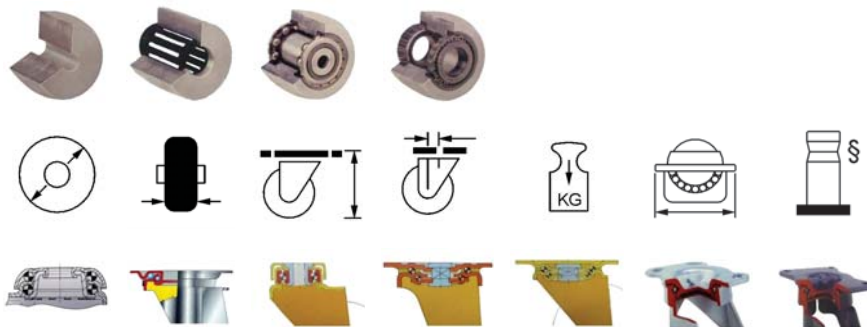

**ROULETTES POUR MEUBLES ET APPAREILS**

2.0 - 2.9



**MÖBEL- UND APPARATE-ROLLEN**

**RUOTE PER MOBILI ED APPARECCHI**



**ROULETTES POUR APPAREILS ET HÔPITAUX**

3.0 - 3.13



**APPARATE- UND SPITAL-ROLLEN**

**RUOTE PER ARREDAMENTO ED OSPEDALI**



**ROULETTES POUR MACHINES À CHARGES ÉLEVÉES**

4.0 - 4.7



**SCHWERLASTROLLEN FÜR MASCHINEN**

**RUOTE PER MACCHINE A CARICHI GRAVOSI**





**SOMMAIRE****INHALT****INDICE****INDEX****ROULETTES POUR TRANSPORTS ET INDUSTRIES****TRANSPORT- UND INDUSTRIE-ROLLEN****RUOTE PER TRASPORTO ED INDUSTRIE**

5.0 - 5.21

**ROULETTES POUR INDUSTRIES, CHARGES ÉLEVÉES****SCHWERLASTROLLEN FÜR INDUSTRIE****RUOTE PER INDUSTRIE A CARICHI GRAVOSI**

6.0 - 6.11

**ROUES - ACCESSOIRES - FIXATIONS****RÄDER - ZUBEHÖR - BEFESTIGUNGEN****RUOTE - ACCESSORI - FISSAZIONI**

7.0 - 7.21

**POULIES POUR CÂBLES - GALETS DE PORTES****DRAHTSEILROLLEN - SCHIEBETORROLLEN****PULEGGE PER CAVI - RULLI DI PORTE**

8.0 - 8.7









## SOMMAIRE

## INHALT

## INDICE

## INDEX

Article - Artikel - Articolo N°	Page Seite Pagina
11... / X-11...	7.1
1430...	2.8
160...	7.16
21...	7.3
21...-G / X-21...-G	7.2
2011...	3.2
2052...	4.6
2061...	3.8
2073...	3.5
2073...-A	3.6
2457...	3.7
32... / X-32...	7.5
3011... / X-3011...	3.1
3061... / X-3061...	3.8
3071... / 2470...	3.4
3073... / X-3073...	3.5
3073...-A / X-3073...-A	3.6
3100...	3.3
3400...	4.2
42...	7.3
43 Cl...	7.12
44 NYR...	7.14
4001...	4.7
4700...	2.1
53... / X-53...	7.5
5002 DS...	2.3
5002 PS...	2.2
5002 MS...	2.5
5011... / X-5011...	5.1
5021...	5.4
5021...-G / X-5021...-G	5.3
5032... / X-5032...	5.7
5042...	5.5
5053... / X-5053...	5.6
5061... / X-5061...	5.17
5069... / X-5069...	5.20
5071... / X-5071...	5.15
5073... / X-5073...	5.11
5073...-A / X-5073...-A	5.13
50 SOF... / X-50 SOF...	5.9
55153...	4.3-5
61... / X-61...	7.13
65... / X-65...	7.14
65 PTR...	7.11
69... / X-69...	7.12
604...	8.1
607...	7.17

Article - Artikel - Articolo N°	Page Seite Pagina
652 Z...	8.3
654 K...	8.4
674...	8.1
690...	8.1
6015... / X-6015...	5.2
6032... / X-6032... / BR...	5.8
6042... / BR-6042...	5.5
6053... / X-6053... / BR...	5.6
6061... / X-6061... / BR...	5.18
6065... / X-6065... / BR...	5.19
6069... / X-6069... / BR...	5.20
6075... / X-6075... / BR...	5.12
6075...-A / X-6075...-A / BR...	5.14
60776... / X-60776... / BR...	5.16
6182...	5.10
71... / X-71...	7.9
73... / X-73...	7.7
73...-A / X-73...-A	7.8
776... / X-776...	7.9
7011... / X-7011...	5.1
7021...	5.4
7021...-G / X-7011...-G	5.3
7032... / X-7032...	5.7
7042...	5.5
7061... / X-7061...	5.17
7071... / X-7071...	5.15
7073... / X-7073...	5.11
7073...-A / X-7073...-A	5.13
82... / 8-P... / 8-S...	7.6
88 PTK...	7.11
8015... / X-8015...	5.2
8022...	5.4
8022...-G / X-8022...-G	5.3
8032... / X-8032...	5.8
8042...	5.5
8061... / X-8061...	5.18
8065... / X-8065...	5.19
8075... / X-8075...	5.12
8075...-A / X-8075...-A	5.14
8082... / X-8082...	5.10
80 DCR... / X-80 DCR...	5.9
93... / ADK...	7.10
9132... / X-9132...	6.2
9153... / X-9153...	6.1
9165... / X-9165...	6.9
9176... / X-9176...	6.3
9176...-A / X-9176...-A	6.4
91776... / X-91776...	6.5
9193...	6.6

Article - Artikel - Articolo N°	Page Seite Pagina
BC...	7.18
Blocage...	7.18
CVK...	8.5
DCK... / X-DCK...	7.6
DR... / X-DR...	7.18
FR...	7.19
G+K...	7.2
H-2013... / BR/H-2013...	3.11
H-2073... / H-2073...-A	3.12
H-20 SOF...	3.11
JX 810 PTS...	6.8
LT/TW 812 PTTS...	6.8
MT...	7.4
R-54V...	8.5
RNY+RPO+RST 87...	7.15
S07+S47... / X-07+S47...	7.19
S71...	7.19
SM... / X-SM...	7.18
SOF... / X-SOF...	7.6
TH/TW 32...	6.2
TH/TW 53...	6.1
TH/TW 65 CIR...	6.11
TH/TW 65 PTR...	6.7
TH/TW 66...	6.9
TH/TW 66 NYK...	6.10
TH/TW 76...	6.3
TH/TW 76...-A	6.4
TH/TW 776...	6.5
TH/TW 93...	6.6
TH+B/TH+THR 65 CIR...	6.11
TH+B/TH+THR 65 PTR...	6.7
TH+B/TH+THR 66 NYK...	6.10
TL+B/TL+TR NY/NYR...	4.1
WCS...	7.4
WP+B/WP 88 PTK...	6.8

Page Seite Pagina	Article	Artikel	Articolo
7.18	Axe	Achse	Asse
7.16	Bille porteuse	Kugelrollen	Rulli sferici
4.7, 7.18-19	Divers	Verschiedene	Vario
3.3, 5.3-5, 7.2-4	Caoutchouc	Gummi	Gomma
4.3, 5.6-8, 6.1-2, 7.4-5	Caoutchouc Elastique	Gummi-Elastisch	Gomma Elastica
3.1-2, 3.11, 5.1-2, 7.1	Caoutchouc Thermoplastique	Gummi-Thermoplastisch	Gomma Thermoplastica
4.7, 7.18-19	Fixation	Befestigung	Sistemi di attacco
4.6, 6.11, 7.12	Fonte	Guss	Ghisa
8.3-6	Galet de porte	Schiebtorrollen	Rulli di porte
3.8, 4.1-3, 5.17-19,	Polyamide / Nylon	Polyamid / Nylon	Poliammide / Nylon
6.9-10, 7.13-14	Polyamide / Nylon	Polyamid / Nylon	Poliammide / Nylon
3.4-7, 3.12, 4.4-5, 5.11-16,	Polyuréthane	Polyurethan	Poliuretano
6.3-5, 7.7-9	Polyuréthane	Polyurethan	Poliuretano
3.6, 3.12, 5.13-14, 6.4, 7.8	Polyuréthane Antistatique	Polyurethan Antistatisch	Poliuretano Antistatico
4.4, 6.6-8, 7.10-11	Polyuréthane + Fonte	Polyurethan + Guss	Poliuretano + Ghisa
3.11, 5.9, 7.6	Pneu-Soft	Soft-Reifen	Pneumatiche-Soft
5.10, 7.6	Pneumatique	Luft-Reifen	Pneumatiche
8.1-2	Poulie pour câble	Drahtseilrollen	Pulegge per cavi
5.20, 7.12	Résine Phénolique / Chaleur	Phenolharz / Hitzbeständig	Resina Fenolica / Alte temp.
7.17	Roulement à billes	Kugellager	Cuscinetti a Sfera
8.7-8.8	Spécialité	Spezialität	Specialità
4.7, 7.20-21	Vérin / Pied de position	Stellfüsse / Gelenkfüsse	Martinetto / Piede di posizione

Page Seite Pagina	Article	Artikel	Articolo
3.0 - 3.13	Appareil	Apparate	Apparecchi
3.0-13, 5.0-14	Hôpital	Spital	Ospedali
6.0 - 6.11	Industrie	Industrie	Industria
4.1 - 4.7	Machine	Maschine	Macchine
2.0 - 2.9	Meuble	Möbel	Mobili
5.0 - 5.21	Transport	Transport	Trasporto
8.0 - 8.7	Poulie / Galet	Seilrollen / Schiebtor	Pulegge / Rulli
7.0 - 7.21	Roue / Divers	Rad / Verschiedene	Ruota / Vario
8.7 - 8.8	Spécialité	Spezialität	Specialità
<b>RABAIS SPÉCIAL / SPEZIAL-RABATT / SCONTO SPECIALE</b>			
2.9	Chaise bureau	Büro-Stuhl	Sedia di ufficio
3.13	Chaise roulante	Rollstuhl	Carrozzina
5.21	Container	Container	Cassonetti
5.21	Flight-cases	Flight-cases	Flight-cases
4.7	Transpalette	Paletthubwagen	Traspallette
3.13	Supermarché	Supermarket	Carrelli-Supermarket
2.9	Statif (hôpital)	Statif (Spital)	Statif (Ospedale)



## SYMBOLES

## SYMBOL

## SIMBOLOGIA

## SYMBOLS

	Diamètre de la roue Raddurchmesser Diametro della ruota Wheel diameter		Roulette pivotante à plaque Lenkrolle mit Platte Ruota girevole Swivel castor
	Largeur de la roue Radbreite Larghezza della ruota Width of wheel		Roulette pivotante à plaque + frein Lenkrolle mit Platte + Feststeller Ruota girevole + freno Total brake castor
	Largeur de la roue (roues jumelées) Radbreite (zwillingsrädern) Larghezza della ruota (doppia ruote) Width of wheel (twin wheels)		Roulette fixe à plaque Bockrolle mit Platte Ruota fissa Fixed castor
	Longueur du moyeu Nabenlänge Lunghezza del mozzo Hub width		Roulette pivotante à trou Lenkrolle mit Loch Ruota foro passante Bolt hole castor
	Diamètre de l'alésage Achsl Lochdurchmesser Diametro foro mozzo Bore diameter		Roulette pivotante à trou + frein Lenkrolle mit Loch + Feststeller Ruota girevole a foro passante + freno Bolt hole castor+ brake
	Types de roulements Radlagerungen Tipo di rotolamento Types of bearings		Tige filetée Gewinde-Zapfen Perno fileteado Screwed stem
	Palier lisse Gleitlager Foro liscio Plain bearings		Vis Schraube Vite Screw
	Roulement à rouleaux Rollenlager Cuscinetto a rulli Roller bearings		Douille à enfoncer avec bague ressort Einsteck-Hülse mit Klemmring Perno liso Smooth stem
	Roulement à billes de précision Rillenkugellager Cuscinetto a sfere Precision ball bearings		Tige avec bague ressort Stift mit Klemmring Perno liso Smooth stem
	Roulement à rouleaux coniques Kegelrollenlager A doppi cuscinetti a rulli conici Tapered roller bearings		Dimension de la plaque Plattengröße Placa Swivel plate
	Dimensions de la plaque Plattengröße Dimensioni piastra Top plate outer dimension		Roulette de meuble avec roues jumelées Möbel-Rollen mit Zwillingsrädern Ruotelle per mobilio, doppia ruota Institutional castors, twin wheels
	Entraxe des trous de fixations Lochabstand Interasse fori piastra Bolt hole spacing		Roulette de meuble, roues jumelées + frein Möbel-Rollen, Zwillingsrädern mit Feststeller Ruotelle per mobilio, doppia ruota + freno Institutional castors, twin wheels + brake
	Diamètre des trous de fixations Befestigungslochdurchmesser Diametro foro piastra Fixing bolt hole diameter		Déport Ausladung Disassamento Offset
	Déport Ausladung Disassamento Offset		Hauteur total Bauhöhe Altezza utile Overrall height
	Hauteur total Bauhöhe Altezza utile Overrall height		Capacité de charge Tragfähigkeit Portata Load capacity





## TYPES DE ROULEMENTS

## RADLAGERUNGEN

## SYSTEMA ROTAZIONI MOZZI

## TYPES OF BEARINGS

**PALIER LISSE**

Logement simple nécessitant peu d'entretien. Insensible au choc. Approprié pour utilisation à l'état mouillé. Pour appareil à faible vitesse.

**GLEITLAGER**

Einfache, weitgehend wartungsfreie Lagerung. Stossunempfindlich. Geeignet für Nassbetrieb. Für Geräte mit geringer Geschwindigkeit.

**FORO LISCIO**

La rotazione avviene direttamente sull'asse della ruota. Indicato per i carichi con portata media.

**PLAIN BEARINGS**

Simple, almost maintenance free bearing. Resistant to shocks. Suitable for use in wet conditions. For low speed vehicles.

**ROULEMENT A ROULEAUX**

Logement robuste, résistant, nécessitant peu d'entretien. Frottement faible dans les paliers. Insensible au choc. Graissage permanent. Le logement le plus utilisé pour des appareils à faible vitesse.

**ROLLENLAGER**

Robuste, widerstandsfähige, weitgehend wartungsfreie Lagerung. Geringe Lagerreibung. Stossunempfindlich. Dauerschmierung. Das meistverwendete Lager für Geräte mit geringer Geschwindigkeit.

**CUSCINETTO A RULLI**

La rotazione avviene su un cuscinetto a rulli. Una saltuaria lubrificazione garantisce una migliore scorrevolezza. Indicato per portata medio-alta.

**ROLLER BEARINGS**

Sturdy, resistant, almost maintenance free bearings, low friction, shock resistant. Permanent lubrication. For low speed vehicles.

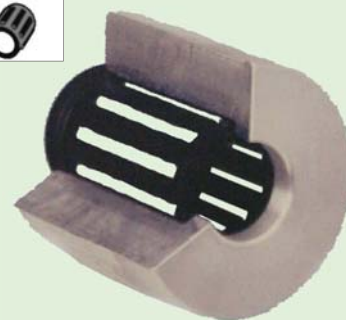
**ROULEMENT A BILLES DE PRECISION**

Marche aisée également en présence de contraintes et vitesses importantes.

**RILLENKUGELLAGER**

Präzisionskugellager, leichter Lauf, auch bei grösseren Belastungen und Geschwindigkeit.

**CUSCINETTO A SFERE DI PRECISIONI**

La rotazione avviene su doppi cuscinetti a sfere. Garantiscono una durata nel tempo con un'ottima scorrevolezza. Indicato per portate pesanti ed extra pesanti.

**PRECISION BALL BEARINGS**

Easy running even at higher loads and speeds.

**ROULEMENT A ROULEAUX CONIQUES**

Utilisation pour des roues à fortes charges pour contraintes élevées. Capacité de charge élevée. Jeu réglable.

**KEGELROLLENLAGER**

Einsatz in Schwerlast-Rädern für hohe Beanspruchungen. Hoch belastbar. Spiel einstellbar.

**CUSCINETTO A RULLI CONICI**

La rotazione avviene su doppi cuscinetti a rulli conici. Garantiscono una durata nel tempo con un'ottima scorrevolezza. Indicati per portate particolarmente gravose con una elevata velocità di traino.

**TAPERED ROLLER BEARINGS**

For heavy duty purposes with high performance. High load capacity. Adjustable play.

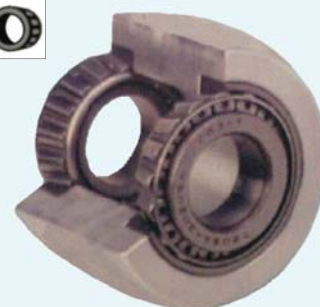

**COMPATIBILITÉ CHIMIQUE / LE CHOIX DE LA ROUE****CHEMISCHE BESTÄNDIGKEIT / AUSWAHL VON RÄDER****COMPATIBILITÀ CHIMICA / LA SCELTA DELLA RUOTA****CHEMICAL COMPATIBILITY / CHOOSING THE WHEEL**

Polyurethane Polyurethan Polyuretano	Polyamide/Nylon Polyamid/Nylon Poliamide/Nylon	Caoutchouc Gummi Gomma Rubber	FRANÇAIS	DEUTSCH	ITALIANO	ENGLISCH
			++ très grande résistance + bonne résistance - résistance limitée -- mauvaise résistance	++ sehr gute Beständigkeit + gute Beständigkeit - geringe Beständigkeit -- schlechte Beständigkeit	++ ottimo resistente + buono resistente - resistenza limitata -- non resistente	++ excellent resistant + good resistant - resistant limitet -- not resistant
-	-	++	Acide acétique 20%	Essigsäure 20%	Acido acetico 20%	Acetic acid 20%
+	+	++	Acide citrique 10% 20°C	Zitronensäure 10% 20°C	Acido citrico 10% 20°C	Citric acid 10% 20°C
--	--	+	Acide chlorhydrique 10%	Salzsäure 10%	Acido cloridrico 10%	Hydrochloric acid 10%
-	--	++	Acide phosphorique 25% 20°C	Phosphorsäure 25% 20°C	Acido fosforico 25% 20°C	Phosphoric acid 25% 20°C
--	--	+	Acide sulfurique 10%	Schwefelsäure 10%	Acido solforico 10%	Sulphuric acid 10%
--	+	+	Ammoniac 20%	Ammoniak 20%	Ammoniacca 20%	Ammonia 20%
-	+	-	Acétone	Azeton	Acetone	Acetone
+	++	--	Benzine	Benzin	Benzina	Gasoline
-	--	--	Chlorure de chaux	Chlorkalk	Cloruro di cementi	Chloride of lime
+	++	++	Eau distillée 50°C	Destilliertes Wasser 50°C	Acqua distillata 50°C	Distilled water
++	+	++	Eau de mer	Meerwasser	Acqua marina	Sea water
++	++	++	Eau	Wasser	Acqua	Water
+	--	--	Eau oxygénée 30%	Wasserstoffperoxyd 30%	Acqua ossigenata 30%	Hydrogen peroxide 30%
++	+	++	Glycérine	Glyzerin	Glicerina	Glycerin
++	++	-	Huile de lin	Leinöl	Oli di lino	Linseed oil
++	++	--	Huile minéral	Mineralöl	Oli minerali	Mineral oil
+	++	-	Huile d'olive	Olivenöl	Oli di Olive	Olive oil
++	++	-	Huile de silicone	Silikonöl	Oli di silicone	Oil of silicone
++	++	-	Huile de soja	Sojaöl	Oli di soia	Soya oil
++	++	++	Lait	Milche	Latte	Milk
+	++	--	Pétrole	Erdöl	Petrolio	Petrol
-	--	--	Phénol	Phenol	Fenolo	Phenol
+	+	--	Sulfure de carbone	Kohlenstoff-Sulfid	Solfure di carbone	Sulfure of carbon
+	+	++	Sulfate de cuivre 10%	Kupfersulfat 10%	Solfato di rame 10%	Copper sulphate 10%
-	++	--	Térébenthine	Terpentin	Trementina	Turpentine
+	+	--	Tétrachlorure de carbone	Tetrachlorkohlenstoff	Tetracloruro di carbone	Carbon tetrachloride
+	+	+	Vapeur	Dampf	Vapore	Steam

CAOUTCHOUC	SUPER-ÉLASTIQUE	PNEUMATIQUE	POLYAMIDE/NYLON	POLYURÉTHANE	FORTE
N'ALTÈRE PAS LES SOLS. FAIBLE RÉSISTANCE AU ROULEMENT. DIFFÉRENTES QUALITÉS DE CAOUTCHOUC. ÉGALEMENT ANTISTATIQUE.	GRANDE ÉLASTICITÉ. CHARGE ADMISSIBLE ÉLEVÉE. TRÈS FAIBLE RÉSISTANCE AU ROULEMENT. GRAND CONFORT AU ROULEMENT.	FAIBLE RÉSISTANCE AU ROULEMENT SUR SOLS INÉGaux, ABÎMÉS ET FRAGILES. EXCELLENT POUVOIR AMORTISSANT. N'ALTÈRE PAS LES SOLS.	CHARGE ADMISSIBLE ÉLEVÉE. RÉSISTE À DE NOMBREUX ACIDES ET BASES. AUCUN ENTRETIEN. GRANDE RÉSISTANCE À L'USURE.	CHARGE ADMISSIBLE ÉLEVÉE. ROULEMENT SOUPLE ET SILENCIEUX. RÉSISTE À L'USURE, AUX COUPURES, AUX HUILES/GRAISSES, À DE NOMBREUX ACIDES/BASES. ÉGALEMENT ANTISTATIQUE.	FORCE TRÈS ÉLEVÉE. RÉSISTE À L'USURE, AUX CHOCS/HUILES/GRAISSES, À DE NOMBREUX ACIDES ET BASES. NE NÉCESSITE AUCUN ENTRETIEN.
<b>GUMMI</b> BODENSCHONEND, GERINGER ANFAHRWIDERSTAND. VERSCHIEDENE GUMMIQUALITÄTEN. AUCH ANTISTATISCH.	<b>SUPER-ELASTISCH</b> HOHE HLASTIZITÄT UND TRAGFÄHIGKEIT. SEHR GERINGER ANFAHRWIDERSTAND. GROSSER GOLLKOMFORT.	<b>LUFT-REIFEN</b> GERINGER ANFAHRWIDERSTAND BEI SCHLECHTEN BODENVERHÄLTNISSEN. SEHR GUTE STOSSDÄMPFUNG, BODENSCHONEND.	<b>POLYAMID/NYLON</b> HOHE BELASTBARKEIT, WEITGEHEND BESTÄNDIG GEGEN SÄUREN UND LAUGEN. WARTUNGSFREI. HOHER ABRIEBWIDERSTAND.	<b>POLYURETHAN</b> HOHE BELASTBARKEIT, GERÄUSCHARMER LAUF. ABRIEB- U. SCHNITTFEST, OEL- UND FETTBESTÄNDIG GEGEN VIELE SÄUREN UND LAUGEN. AUCH ANTISTATISCH.	<b>GUSS</b> HOHE TRAGFÄHIGKEIT. ABRIEBFEST. STOSS-UNEMPFFINDLICH, ABRIEB- UND SCHNITTFEST, OEL- UND FETTBESTÄNDIG GEGEN VIELE SÄUREN U. LAUGEN. WARTUNGSFREI.
<b>GOMMA</b> NON ALTERA IL SUOLO. RESISTENZA DEBOLE AD IL ROTOLANTE. VARIE QUALITÀ DI GOMMA. ANCHE ANTISTATICO.	<b>GOMMA-ELASTICO</b> GRANDE ELASTICITÀ. ELEVATO CARICO AMMISSIBILE. RESISTENZA MOLTO DEBOLE AD IL ROTOLANTE. GRANDE CONFORTO AD IL ROTOLANTE.	<b>PNEUMATICA</b> RESISTENZA DEBOLE AD IL ROTOLANTE SU SUOLI DISUGUALI, DANNEGGIATO E FRAGILE. POTERE ASSORBENDO ECCELLENTE. NON ALTERI SUOLI.	<b>POLIAMMIDE/NYLON</b> CARICO AMMISSIBILE ELEVATO. RESISTA AD NUMEROSI ACIDI E BASI. NIENTE INTERVISTA. GRANDE RESISTENZA ALL'USURA.	<b>POLIURETANO</b> CARICO AMMISSIBILE ELEVATO. ROTOLANDO FLESSIBILE E SILENZIOSO. RESISTE ALL'USURA, AI TAGLI A PETROLI, AI GRASSI, A NUMEROSI ACIDI E BASI. ANCHE ANTISTATICO.	<b>GHISA</b> FORZA MOLTO ELEVATA. RESISTE ALL'USURA, AI COLPI, A PETROLI AI GRASSI, A NUMEROSI ACIDI E BASI. NON RICHIEDA INTERVISTA.
<b>RUBBER</b> DO NOT DISTORT GROUNDS. WEAK RESISTANCE IN THE MOVEMENT. VARIOUS RUBBER QUALITIES. ALSO ANTISTATIC.	<b>ELASTIC RUBBER</b> BIG ELASTICITY. HIGH ACCEPTABLE LOAD. VERY WEAK RESISTANCE IN THE MOVEMENT. BIG COMFORT IN THE MOVEMENT.	<b>PNEUMATIC</b> WEAK RESISTANCE IN THE SURE MOVEMENT UNEVEN, DAMAGED AND FRAGILE GROUNDS. EXCELLENT WEAKENING POWER. DO NOT DISTORT GROUNDS.	<b>POLYAMIDE/NYLON</b> HIGH ACCEPTABLE LOAD. RESIST TO NUMEROUS ACIDS AND BASE. NO MAINTENANCE. BIG WEAR RESISTANCE.	<b>POLYURÉTHANE</b> HIGH ACCEPTABLE LOAD. SUPPLE AND SILENT MOVEMENT. RESIST TO THE WEAR, TO THE CUTS, TO THE OIL/FATS, TO THE NUMEROUS ACIDS AND BASE. ALSO ANTISTATIC.	<b>CAST IRON</b> VERY HIGH STRENGTH. RESIST TO THE WEAR, TO THE SHOCKS, TO THE OIL/FATS, IN NUMEROUS ACIDS AND BASE. REQUIRE NO MAINTENANCE.





## SUPPORTS

## GEHÄUSE

## SUPPORTI

## HOUSING

## SÉRIE 3 'LEGER'

page 3.1-3.9



80 kg

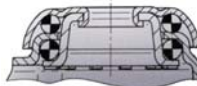

PIVOTEMENT SUR DOUBLE RANGÉE DE BILLES, SUPPORT EN ACIER ZINGUÉ-PROMATISÉ / INOXYDABLE

SCHWENKLAGER MIT ZWEIFACHEM KUGELKRANZ, GEHÄUSE AUS STAHLBLECH VERZINKT-PROMATISIERT / ROSTFREI

PIROETTAMENTO A DOPPIA CORONA DI SFERE, SUPPORTI IN LAMIERA D'ACCIAIO STAMPATA ZINCATO-CROMATO / INOX

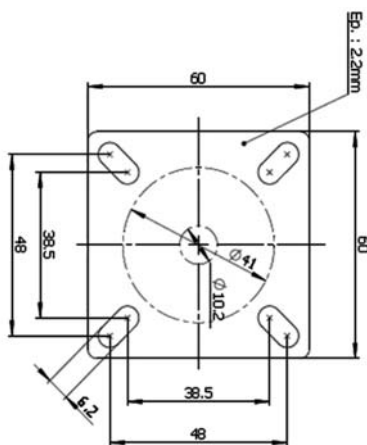

ROULETTE PIVOTANTE 360°  
AVEC PLAQUE OU AVEC TROU CENTRAL  
LENKROLLE 360°  
MIT PLATTE ODER MIT ZENTRALE-LOCH  
RUOTA GIREVOLE 360°  
A PIASTRA O A FORO PASSANTE



ROULETTE PIVOTANTE 360°, AVEC PLAQUE / TROU  
+ FREIN AVANT "TOTAL" (ROUE + PIVOTEMENT)  
LENKROLLE 360°, MIT PLATTE / LOCH  
+ VORNE-BREMSE "TOTAL" (RAD + DREHUNG)  
RUOTA GIREVOLE 360°, A PIASTRA / FORO  
+ FRENO ANTERIORE "TOTAL" (RUOTA + ROTAZIONE)



ROULETTE FIXE, AVEC PLAQUE  
BOCKROLLE, MIT PLATTE  
RUOTA FISSA, A PIASTRA



## SÉRIE 2 'MEDIA'

page 3.1-3.9



120 kg



PIVOTEMENT SUR DOUBLE RANGÉE DE BILLES, SUPPORT EN ACIER ZINGUÉ-PROMATISÉ / INOXYDABLE

SCHWENKLAGER MIT ZWEIFACHEM KUGELKRANZ, GEHÄUSE AUS STAHLBLECH VERZINKT-PROMATISIERT / ROSTFREI

PIROETTAMENTO A DOPPIA CORONA DI SFERE, SUPPORTI IN LAMIERA D'ACCIAIO STAMPATA ZINCATO-CROMATO / INOX

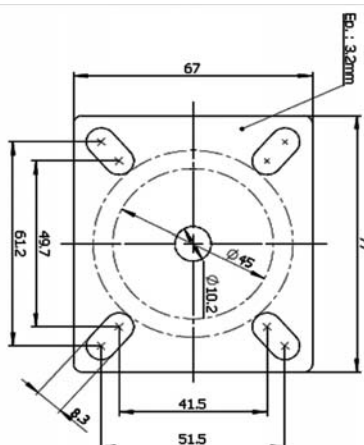

ROULETTE PIVOTANTE 360°  
AVEC PLAQUE OU AVEC TROU CENTRAL  
LENKROLLE 360°  
MIT PLATTE ODER MIT ZENTRALE-LOCH  
RUOTA GIREVOLE 360°  
A PIASTRA O A FORO PASSANTE



ROULETTE PIVOTANTE 360°, AVEC PLAQUE / TROU  
+ FREIN AVANT "TOTAL" (ROUE + PIVOTEMENT)  
LENKROLLE 360°, MIT PLATTE / LOCH  
+ VORNE-BREMSE "TOTAL" (RAD + DREHUNG)  
RUOTA GIREVOLE 360°, A PIASTRA / FORO  
+ FRENO ANTERIORE "TOTAL" (RUOTA + ROTAZIONE)



ROULETTE FIXE, AVEC PLAQUE / TROU  
BOCKROLLE, MIT PLATTE / LOCH  
RUOTA FISSA, A PIASTRA / FORO



ROULETTE FIXE, AVEC PLAQUE  
+ FREIN (ROUE)  
BOCKROLLE, MIT PLATTE  
+ BREMSE (RAD)  
RUOTA FISSA, A PIASTRA  
+ FRENO (RUOTA)



## SÉRIE H 'MEDIA'

page 3.10-3.13



120 kg



PIVOTEMENT SUR ROULEMENT À BILLES 2RS, SUPPORT EN NYLON RENFORCÉ AVEC DES FIBRES DE VERRE, PROTÉGÉE CONTRE LA POUSSIÈRE ET L'ASPERSION D'EAU, PRÉVU POUR LA STÉRILISATION VAPEUR (+110°C)

SCHWENKLAGER MIT KUGELLAGER 2RS, GEHÄUSE AUS NYLON MIT GLASFASERVERSTÄRKTEM VERBINDUNG, STAUB- UND WASSERGESCHÜTZT, AUCH FÜR DAMPFSTERILISATION (+110°C)

PIROETTAMENTO SU CUSCINETTO A SFERE 2RS, SUPPORTI IN NYLON RINFORZATO CON FIBRA DI VETRO, PROTETTO CONTRO LA POLVERE E LE ASPERSIONI DI ACQUA, PREVISTA PER LA STERILIZZAZIONE CON VAPORE (+110°C)

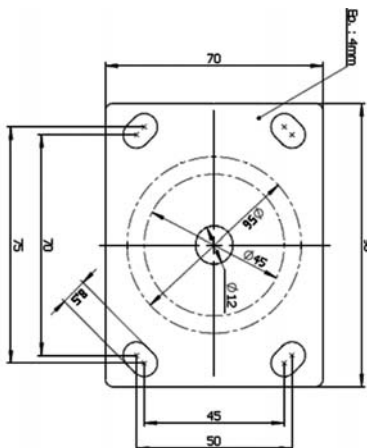

ROULETTE PIVOTANTE 360°  
AVEC PLAQUE OU AVEC TROU CENTRAL  
LENKROLLE 360°  
MIT PLATTE ODER MIT ZENTRALE-LOCH  
RUOTA GIREVOLE 360°  
A PIASTRA O A FORO PASSANTE



ROULETTE PIVOTANTE 360°, AVEC PLAQUE / TROU  
+ FREIN AVANT "TOTAL" (ROUE + PIVOTEMENT)  
LENKROLLE 360°, MIT PLATTE / LOCH  
+ VORNE-BREMSE "TOTAL" (RAD + DREHUNG)  
RUOTA GIREVOLE 360°, A PIASTRA / FORO  
+ FRENO ANTERIORE "TOTAL" (RUOTA + ROTAZIONE)



ROULETTE PIVOTANTE 360°, AVEC PLAQUE /  
TROU + BLOCAGE DE DIRECTION  
LENKROLLE 360°, MIT PLATTE / LOCH  
+ RICHTUNGSFESTSTELLER  
RUOTA GIREVOLE 360°, A PIASTRA / FORO  
+ BLOCCAGGIO DIREZIONALE





## SUPPORTS

## GEHÄUSE

## SUPPORTI

## HOUSING

## SÉRIE 7 'LEGER'

page 5.1-5.21

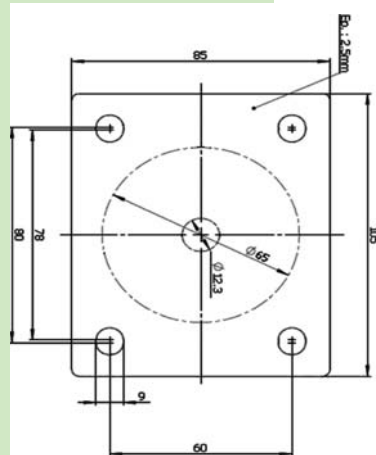

PIVOTEMENT SUR DOUBLE RANGÉE DE BILLES, SUPPORT EN ACIER ZINGUÉ-PROMATISÉ / INOXYDABLE

SCHWENKLAGER MIT ZWEIFACHEM KUGELKRANZ, GEHÄUSE AUS STAHLBLECH VERZINKT-PROMATISIERT / ROSTFREI  
PIROETTAMENTO A DOPPIA CORONA DI SFERE, SUPPORTI IN LAMIERA D'ACCIAIO STAMPATA ZINCATO-CROMATO / INOXROULETTE PIVOTANTE 360°  
AVEC PLAQUE OU AVEC TROU CENTRAL  
LENKROLLE 360°  
MIT PLATTE ODER MIT ZENTRALE-LOCH  
RUOTA GIREVOLE 360°  
A PIASTRA O A FORO PASSANTEROULETTE PIVOTANTE 360°, AVEC PLAQUE / TROU  
+ FREIN AVANT "TOTAL" (ROUE + PIVOTEMENT)  
LENKROLLE 360°, MIT PLATTE / LOCH  
+ VORNE-BREMSE "TOTAL" (RAD + DREHUNG)  
RUOTA GIREVOLE 360°, A PIASTRA / FORO  
+ FRENO ANTERIORE "TOTAL" (RUOTA + ROTAZIONE)ROULETTE FIXE, AVEC PLAQUE  
BOCKROLLE, MIT PLATTE  
RUOTA FISSA, A PIASTRA

## SÉRIE 5 'MEDIA'

page 5.1-5.21

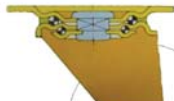

PIVOTEMENT SUR DOUBLE RANGÉE DE BILLES, SUPPORT EN ACIER ZINGUÉ-PROMATISÉ / INOXYDABLE

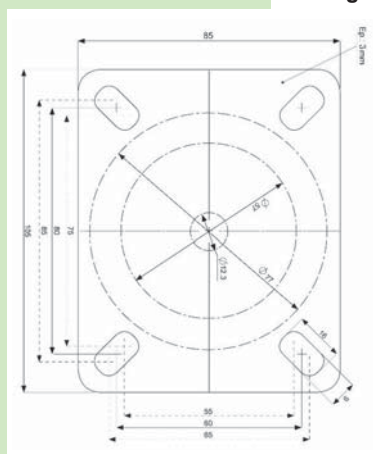
SCHWENKLAGER MIT ZWEIFACHEM KUGELKRANZ, GEHÄUSE AUS STAHLBLECH VERZINKT-PROMATISIERT / ROSTFREI  
PIROETTAMENTO A DOPPIA CORONA DI SFERE, SUPPORTI IN LAMIERA D'ACCIAIO STAMPATA ZINCATO-CROMATO / INOXROULETTE PIVOTANTE 360°  
AVEC PLAQUE OU AVEC TROU CENTRAL  
LENKROLLE 360°  
MIT PLATTE ODER MIT ZENTRALE-LOCH  
RUOTA GIREVOLE 360°  
A PIASTRA O A FORO PASSANTEROULETTE PIVOTANTE 360°, AVEC PLAQUE / TROU  
+ FREIN AVANT RÉGLABLE "TOTAL" (ROUE + PIVOTEMENT)  
LENKROLLE 360°, MIT PLATTE / LOCH + VORNE-BREMSE-  
EINSTELLUNGS "TOTAL" (RAD + DREHUNG)  
RUOTA GIREVOLE 360°, A PIASTRA / FORO + FRENO  
ANTERIORE REGOLABILE "TOTAL" (RUOTA + ROTAZIONE)ROULETTE FIXE, AVEC PLAQUE  
BOCKROLLE, MIT PLATTE  
RUOTA FISSA, A PIASTRAROULETTE PIVOTANTE 360°, AVEC PLAQUE  
+ BLOCCAGE DE DIRECTION  
LENKROLLE 360°, MIT PLATTE  
+ RICHTUNGSFESTSTELLER  
RUOTA GIREVOLE 360°, A PIASTRA  
+ BLOCCAGGIO DIREZIONALEsur demande  
auf AnfrageROULETTE FIXE, AVEC PLAQUE  
+ FREIN (ROUE)  
BOCKROLLE, MIT PLATTE  
+ BREMSE (RAD)  
RUOTA FISSA, A PIASTRA  
+ FRENO (RUOTA)

## SÉRIE 8 'MEDIA'

page 5.1-5.21

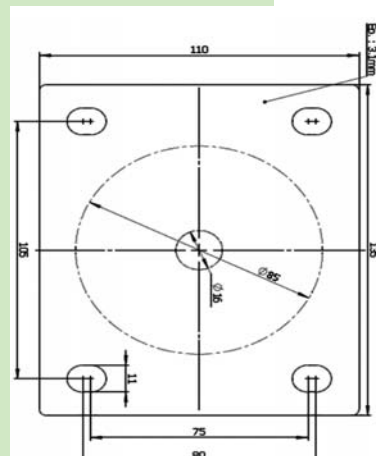

PIVOTEMENT SUR DOUBLE RANGÉE DE BILLES, SUPPORT EN ACIER ZINGUÉ-PROMATISÉ / INOXYDABLE

SCHWENKLAGER MIT ZWEIFACHEM KUGELKRANZ, GEHÄUSE AUS STAHLBLECH VERZINKT-PROMATISIERT / ROSTFREI  
PIROETTAMENTO A DOPPIA CORONA DI SFERE, SUPPORTI IN LAMIERA D'ACCIAIO STAMPATA ZINCATO-CROMATO / INOXROULETTE PIVOTANTE 360°  
AVEC PLAQUE OU AVEC TROU CENTRAL  
LENKROLLE 360°  
MIT PLATTE ODER MIT ZENTRALE-LOCH  
RUOTA GIREVOLE 360°  
A PIASTRA O A FORO PASSANTEROULETTE PIVOTANTE 360°, AVEC PLAQUE / TROU  
+ FREIN AVANT "TOTAL" (ROUE + PIVOTEMENT)  
LENKROLLE 360°, MIT PLATTE / LOCH  
+ VORNE-BREMSE "TOTAL" (RAD + DREHUNG)  
RUOTA GIREVOLE 360°, A PIASTRA / FORO  
+ FRENO ANTERIORE "TOTAL" (RUOTA + ROTAZIONE)ROULETTE FIXE, AVEC PLAQUE  
BOCKROLLE, MIT PLATTE  
RUOTA FISSA, A PIASTRA







## SUPPORTS

## GEHÄUSE

## SUPPORTI

## HOUSING

## SÉRIE 9 'EXTRA'

page 6.1-6.11

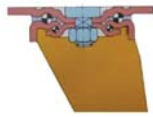
  
 1500 kg

LARGE PALIER DE PIVOTEMENT SUR DOUBLE RANGÉE DE BILLES, INDÉFORMABLE, SUPPORT EN ACIER TREMPÉ RENFORCÉ, ZINGUÉ-PROMATISÉ / INOXYDABLE

BREITES SCHWENKLÄGER MIT ZWEIFACHEM KUGELKRANZ, VERSCHLEISSFEST, GEHÄUSE AUS GEHÄRTETEM STAHL, VERZINKT-PROMATISIERT / ROSTFREI

GRANDE PIROETTAMENTO A DOPPIA CORONA DI SFERE, INALTERABILE, SUPPORTI SU PISTE LAMIERA D'ACCIAIO TEMPERATO, ZINCATO-CROMATO / INOX

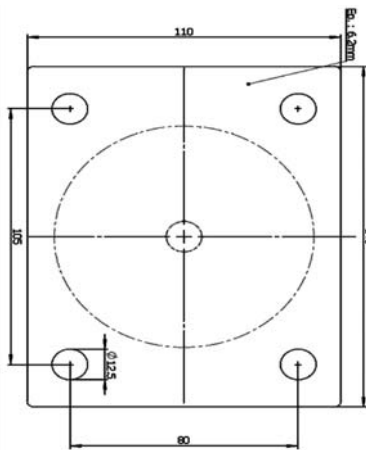

ROULETTE PIVOTANTE 360°, AVEC PLAQUE  
LENKROLLE 360°, MIT PLATTE  
RUOTA GIREVOLE 360°, A PIASTRA



ROULETTE PIVOTANTE 360°, AVEC PLAQUE, + **FREIN ARRIÈRE RÉGLABLE "TOTAL"** (ROUE + PIVOTEMENT)  
LENKROLLE 360°, MIT PLATTE + **HINTER-BREMSE-EINSTELLUNGS "TOTAL"** (RAD + DREHUNG)  
RUOTA GIREVOLE 360°, A PIASTRA + **FRENO POSTERIORE REGOLABILE "TOTAL"** (RUOTA + ROTAZIONE)



ROULETTE FIXE, AVEC PLAQUE  
BOCKROLLE, MIT PLATTE  
RUOTA FISSA, A PIASTRA



## SÉRIE TH 'EXTRA'

page 6.1-6.11

  
 2700 kg

LARGE PALIER DE PIVOTEMENT AXIAL SUR RANGÉE DE BILLES ET ROUEMENTS CONIQUES, INDÉFORMABLE, SUPPORT EN ACIER TREMPÉ RENFORCÉ, PROMAT-ZINGUÉ

BREITES SCHWENKLÄGER MIT AXIAL-KUGELKRANZ UND KEGELROLLENLAGER, VERSCHLEISSFEST, GEHÄUSE AUS GEHÄRTETEM STAHL, PROMAT-VERZINKT

GRANDE PIROETTAMENTO SU CUSCINETTO ASSIALE A SFERE E CUSCINETTO A RULLI CONICI, INALTERABILE, SUPPORTI SU PISTE LAMIERA D'ACCIAIO TEMPERATO, ZINCATO

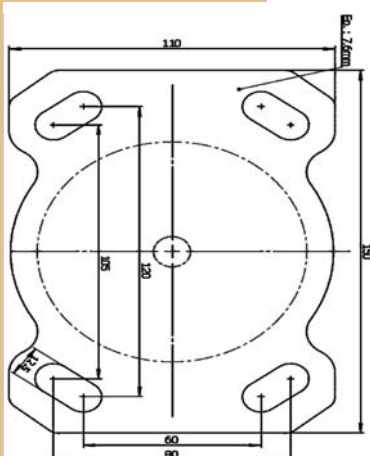

ROULETTE PIVOTANTE 360°, AVEC PLAQUE  
LENKROLLE 360°, MIT PLATTE  
RUOTA GIREVOLE 360°, A PIASTRA



ROULETTE PIVOTANTE 360°, AVEC PLAQUE + **FREIN ARRIÈRE "TOTAL"** (ROUE + PIVOTEMENT)  
LENKROLLE 360°, MIT PLATTE + **HINTER-BREMSE "TOTAL"** (RAD + DREHUNG)  
RUOTA GIREVOLE 360°, A PIASTRA + **FRENO POSTERIORE "TOTAL"** (RUOTA + ROTAZIONE)



ROULETTE FIXE, AVEC PLAQUE  
BOCKROLLE, MIT PLATTE  
RUOTA FISSA, A PIASTRA



ROULETTE PIVOTANTE 360°, AVEC PLAQUE + **BLOCCAGE DE DIRECTION**  
LENKROLLE 360°, MIT PLATTE + **RICHTUNGSFESTSTELLER**  
RUOTA GIREVOLE 360°, A PIASTRA + **BLOCCAGGIO DIREZIONALE**



sur demande  
auf Anfrage

## SÉRIE WP/LT

'MAXI'

page 6.1-6.11

  
 6500 kg

LARGE PALIER DE PIVOTEMENT AXIAL SUR RANGÉE DE BILLES ET ROUEMENTS CONIQUES, INDÉFORMABLE, SUPPORT EN ACIER TREMPÉ RENFORCÉ, PROMAT-ZINGUÉ

BREITES SCHWENKLÄGER MIT AXIAL-KUGELKRANZ UND KEGELROLLENLAGER, VERSCHLEISSFEST, GEHÄUSE AUS GEHÄRTETEM STAHL, PROMAT-VERZINKT

GRANDE PIROETTAMENTO SU CUSCINETTO ASSIALE A SFERE E CUSCINETTO A RULLI CONICI, INALTERABILE, SUPPORTI SU PISTE LAMIERA D'ACCIAIO TEMPERATO, ZINCATO

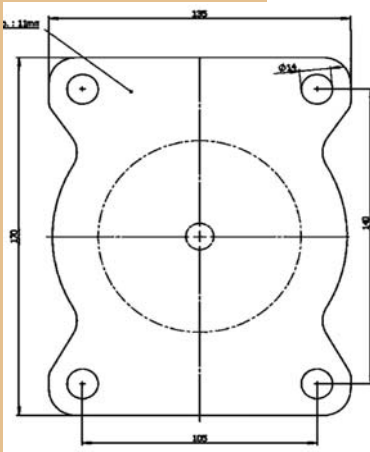

ROULETTE PIVOTANTE 360°, AVEC PLAQUE  
LENKROLLE 360°, MIT PLATTE  
RUOTA GIREVOLE 360°, A PIASTRA



ROULETTE PIVOTANTE 360°, AVEC PLAQUE + **FREIN ARRIÈRE "TOTAL"** (ROUE + PIVOTEMENT)  
LENKROLLE 360°, MIT PLATTE + **HINTER-BREMSE "TOTAL"** (RAD + DREHUNG)  
RUOTA GIREVOLE 360°, A PIASTRA + **FRENO POSTERIORE "TOTAL"** (RUOTA + ROTAZIONE)



ROULETTE FIXE, AVEC PLAQUE  
BOCKROLLE, MIT PLATTE  
RUOTA FISSA, A PIASTRA



ROULETTE PIVOTANTE 360°, AVEC PLAQUE  
LENKROLLE 360°, MIT PLATTE  
RUOTA GIREVOLE 360°, A PIASTRA



ROULETTE PIVOTANTE 360°, AVEC PLAQUE + **BLOCCAGE DE DIRECTION**  
LENKROLLE 360°, MIT PLATTE + **RICHTUNGSFESTSTELLER**  
RUOTA GIREVOLE 360°, A PIASTRA + **BLOCCAGGIO DIREZIONALE**

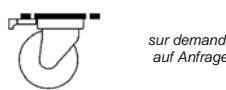

sur demande  
auf Anfrage

ROULETTE FIXE, AVEC PLAQUE  
BOCKROLLE, MIT PLATTE  
RUOTA FISSA, A PIASTRA





# ROULETTES POUR MEUBLES

# MÖBEL-ROLLEN

# RUOTE PER MOBILI

# 2

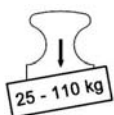

25 – 110 kg



14 - 125 mm

## INDEX / INHALT / INDICE



**PAGE 2.1**  
ZAMAC CHROME  
ZINKDRÜCKGUSS  
ZAMA CROMATA



**PAGE 2.2**  
POLYAMIDE  
POLYAMID  
POLIAMMIDE



**PAGE 2.3-4**  
POLYURETHANE  
POLYURETHAN  
POLIURETANO



**PAGE 2.3**  
ZAMAC CHROME  
ZINKDRÜCKGUSS  
ZAMA CROMATA



**PAGE 2.3-4**  
ANTISTATIQUE  
ANTISTATISCH  
ANTISTATICO



**PAGE 2.4**  
ZAMAC CHROME  
ZINKDRÜCKGUSS  
ZAMA CROMATA



**PAGE 2.5-7**  
ANTIMICROBIEN  
ANTIMIKROBIELLE  
ANTIMICROBIANE



**PAGE 2.5-7**  
ANTIMICROBIEN  
ANTIMIKROBIELLE  
ANTIMICROBIANE



**PAGE 2.8**  
NYLON-CAOUTCH  
NYLON - GUMMI  
NYLON - GOMMA



**PAGE 2.8**  
CAOUTCHOUC  
GUMMI  
GOMMA

## SECTEURS / BEREICHE / SETTORI



**PAGE 2.9**  
ACTION.BUREAU  
AKTION.BURO  
ACTION.UFFICIO



**PAGE 2.9**  
HOPITAL.STATIF  
SPITAL.STATIF  
OSPEDAL.STATIF

**ROULETTES POUR MEUBLES ET APPAREILS**

PIVOTEMENT SUR SIMPLE RANGÉE DE BILLES  
ROUE À PALIER LISSE

**MÖBEL- UND APPARATE-ROLLEN**

SCHWENKLAGER MIT EINFACHEM KUGELKRANZ  
RAD MIT GLEITLAGER

**RUOTE PER MOBILI ED APPARECCHI**

PIROETTAMENTO SU SEMPLICE CORONA DI SFERE  
RUOTA A FORO LISCIO

40 kg

**CAOUTCHOUC**

Roue en Caoutchouc Plein, gris, roue à palier lisse, non-tachant, silencieux, capot en Zamac chromé, corps/roue: Polyamide roulette avec fixation à vis/tige lisse/plaque

RECOMMANDÉ POUR LES SOLS DURS

**GUMMI**

Rad mit Vollgummi, grau, Rad mit Gleitlager, spurfrei, Laufruhe, Gehäuse aus Zinkdruckguss verchromt, Radkörper: Polyamid Lenkrolle mit Befestigung -Schraube/Stift/Platte

EMPFOHLEN FÜR HARTE BÖDEN

**GOMMA**

Ruota in Gomma, grigia, ruota a foro liscio, antitraccia, silenzia, Supporti in Zama cromata, corpo centrale: Poliamide rotelle con fissazioni a vite/perno liso/piastra

RACCOMANDATÒ PER I PAVIMENTI DURI

**POLYURETHANE**

Roue Polyuréthane injecté, gris/noir, roue à palier lisse, non-tachant, silencieux, support en Zamac chromé, corps/roue: Polyamide roulette avec fixation à vis/tige lisse/plaque

RECOMMANDÉ POUR LES SOLS DURS/MOUS

**POLYURETHAN**

Rad mit Spritzguss-Polyurethan, grau/schwarz, Rad mit Gleitlager, spurfrei, Laufruhe, Gehäuse aus Zinkdruckguss verchromt, Radkörper: Polyamid Lenkrolle mit Befestigung -Schraube/Stift/Platte

EMPFOHLEN FÜR HARTE/WEICHE BÖDEN

**POLIURETANO**

Ruota rivestimento in Poliuretano iniettato, grigia/nero, ruota a foro liscio, antitraccia, silenzia, Supporti in Zama cromata, corpo centrale: Poliamide rotelle con fissazioni a vite/perno liso/piastra

RACCOMANDATÒ PER I PAVIMENTI DURI/MOLLI

CAOUTCHOUC / GUMMI / GOMMA

POLYURÉTHANE / POLIURETANO

								ROUE PIVOTANTE LENKROLLE RUOTA GIREVOLE	Prix Preis Prezzo	PIVOTANT/FREIN LENKROLLE/BREMS GIREVOLE/FRENO	Prix Preis Prezzo					Prix Preis Prezzo	ROUE PIVOTANTE LENKROLLE RUOTA GIREVOLE	Prix Preis Prezzo	PIVOTANT/FREIN LENKROLLE/BREMS GIREVOLE/FRENO	Prix Preis Prezzo
mm	mm	Page 1.6	kg	mm	mm	mm	mm	Art. N :	CHF sans TVA	Art. N :	CHF sans TVA	Art. N :	CHF sans TVA	Art. N :	CHF sans TVA	Art. N :	CHF sans TVA	Art. N :	CHF sans TVA	
50	19		40	M8x15	---	---	69	21	4700 G 05.78	24.90	4705 G 05.78	26.10	---	---	---	---	4700 DL 05.78	23.30	4705 DL 05.78	27.30
50	19		40	M10x15	---	---	69	21	4700 G 05.71	24.90	4705 G 05.71	26.40	---	---	---	---	4700 DL 05.71	23.30	4705 DL 05.71	27.30

								ROUE PIVOTANTE LENKROLLE RUOTA GIREVOLE	Prix Preis Prezzo	PIVOTANT/FREIN LENKROLLE/BREMS GIREVOLE/FRENO	Prix Preis Prezzo					Prix Preis Prezzo	ROUE PIVOTANTE LENKROLLE RUOTA GIREVOLE	Prix Preis Prezzo	PIVOTANT/FREIN LENKROLLE/BREMS GIREVOLE/FRENO	Prix Preis Prezzo
mm	mm	Page 1.6	kg	mm	mm	mm	mm	Art. N :	CHF sans TVA	Art. N :	CHF sans TVA	Art. N :	CHF sans TVA	Art. N :	CHF sans TVA	Art. N :	CHF sans TVA	Art. N :	CHF sans TVA	
50	19		40	10x34	---	---	69	21	4700 G 05.50	22.40	4705 G 05.50	26.70	---	---	---	---	4700 DL 05.50	23.50	4705 DL 05.50	27.60
50	19		40	11x22	---	---	69	21	4700 G 05.55	26.10	4705 G 05.55	30.40	---	---	---	---	4700 DL 05.55	27.30	4705 DL 05.55	31.10

								ROUE PIVOTANTE LENKROLLE RUOTA GIREVOLE	Prix Preis Prezzo	PIVOTANT/FREIN LENKROLLE/BREMS GIREVOLE/FRENO	Prix Preis Prezzo					Prix Preis Prezzo	ROUE PIVOTANTE LENKROLLE RUOTA GIREVOLE	Prix Preis Prezzo	PIVOTANT/FREIN LENKROLLE/BREMS GIREVOLE/FRENO	Prix Preis Prezzo
mm	mm	Page 1.6	kg	mm	mm	mm	mm	Art. N :	CHF sans TVA	Art. N :	CHF sans TVA	Art. N :	CHF sans TVA	Art. N :	CHF sans TVA	Art. N :	CHF sans TVA	Art. N :	CHF sans TVA	
50	19		40	39x39	23x23 29x29	5.2	69	21	4700 G 05.60	23.70	4705 G 05.60	26.70	---	---	---	---	4700 DL 05.60	23.50	4705 DL 05.60	27.80

RABAIS SPÉCIAL 'SET-BUREAU' PAGE 2.9

SPEZIAL-RABATT 'SET-BÜRO' SEITE 2.9

SCONTO SPECIALE 'SET-UFFICIO' PAGINA 2.9

Applications / Anwedung / Applicazioni



Variantes / Varianten / Varianti

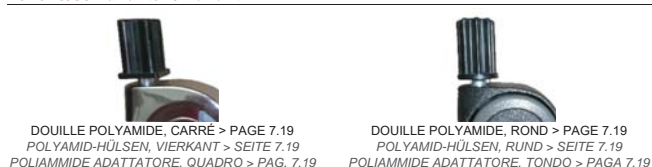







**ROULETTES POUR MEUBLES ET APPAREILS**

PIVOTEMENT SUR SIMPLE RANGÉE DE BILLES  
ROUE À PALIER LISSE

**MÖBEL- UND APPARATE-ROLLEN**

SCHWENKLAGER MIT EINFACHEM KUGELKRANZ  
RAD MIT GLEITLAGER

**RUOTE PER MOBILI ED APPARECCHI**

PIROETTAMENTO SU SEMPLICE CORONA DI SFERE  
RUOTA A FORO LISCIO

55 - 100 kg

**POLYURÉTHANE**

Roue Polyuréthane injecté, gris/noir, roue à palier lisse, non-tachant, silencieux, corps/roue: Polyamide, support en Polyamide ou Zamac chromé roulette jumelée avec fixation à vis/tige lisse/plaque

RECOMMANDÉ POUR LES SOLS DURS

**POLYURETHAN**

Rad mit Spritzguss-Polyurethan, grau/schwarz, Rad mit Gleitlager, spurfrei, Laufruhe, Radkörper: Polyamid, Gehäuse aus Polyamid oder Zinkdruckguss verchromt  
Zwillinge/Lenkrolle mit Befestigung -Schraube/Stift/Platte

EMPFOHLEN FÜR HARTE BÖDEN

**POLIURETANO**

Ruota rivestimento in Poliuretano iniettato, grigio/nero, ruota a foro liscio, antiraccia, silenziosa, corpo centrale: Poliammide, supporti in Poliammide o in Zama cromata  
rotelle gemellate con fissazioni a vite/perno liso/piastra

RACCOMANDATÒ PER I PAVIMENTI DURI

SUPPORT POLYAMIDE / POLYAMID-GEHÄUSE / SUPPORTI IN POLIAMMIDE

ZAMAC CHROMÉ / ZAMAK / ZAMA

POLYURÉTHANE								ROUE PIVOTANTE LENKROLLE RUOTA GIREVOLE		PIVOTANT/FREIN LENKROLLE/BREMS GIREVOLE/FRENO		ROUE PIVOTANTE LENKROLLE RUOTA GIREVOLE		PIVOTANT/FREIN LENKROLLE/BREMS GIREVOLE/FRENO		ROUE PIVOTANTE LENKROLLE RUOTA GIREVOLE		PIVOTANT/FREIN LENKROLLE/BREMS GIREVOLE/FRENO	
mm	mm	Page 1.6	kg	mm	mm	mm	mm	Art. N :	CHF sans TVA	Art. N :	CHF sans TVA	Art. N :	CHF sans TVA	Art. N :	CHF sans TVA	Art. N :	CHF sans TVA	Art. N :	CHF sans TVA
65	2x14		55	M8x15	---	---	72 30	5102 DS 06.78	10.90	5105 DS 06.78	17.00	5102 DS 06.78-A	20.90	5105 DS 06.78-A	27.40	5102 DS 06.78-C	14.40	5105 DS 06.78-C	19.60
65	2x14		55	M10x15	---	---	72 30	5102 DS 06.71	10.90	5105 DS 06.71	17.00	5102 DS 06.71-A	20.90	5105 DS 06.71-A	27.40	5102 DS 06.71-C	14.40	5105 DS 06.71-C	19.60
100	2x17		100	M10x20	---	---	120 40	5102 DS 10.71	41.00	5105 DS 10.71	59.60	5102 DS 10.71-A	58.00	5105 DS 10.71-A	69.00	5102 DS 10.71-C	53.10	5105 DS 10.71-C	75.30
100	2x17		100	M12x20	---	---	120 40	5102 DS 10.72	41.20	5105 DS 10.72	60.00	5102 DS 10.72-A	58.40	5105 DS 10.72-A	69.40	5102 DS 10.72-C	53.50	5105 DS 10.72-C	75.70
125	2x17		110	M10x20	---	---	145 40	5102 DS 12.71	77.10	5105 DS 12.71	91.80	sur demande auf Anfrage		---	---	---	---	---	---

A) AUSSI AVEC VIS M12x20mm, +CHF 2.00 / AUCH MIT SCHRAUBE M12x20mm, +CHF 2.00 / ANCHE CON VITE M12x20mm, +CHF 2.00

POLYURÉTHANE								ROUE PIVOTANTE LENKROLLE RUOTA GIREVOLE		PIVOTANT/FREIN LENKROLLE/BREMS GIREVOLE/FRENO		ROUE PIVOTANTE LENKROLLE RUOTA GIREVOLE		PIVOTANT/FREIN LENKROLLE/BREMS GIREVOLE/FRENO		ROUE PIVOTANTE LENKROLLE RUOTA GIREVOLE		PIVOTANT/FREIN LENKROLLE/BREMS GIREVOLE/FRENO	
mm	mm	Page 1.6	kg	mm	mm	mm	mm	Art. N :	CHF sans TVA	Art. N :	CHF sans TVA	Art. N :	CHF sans TVA	Art. N :	CHF sans TVA	Art. N :	CHF sans TVA	Art. N :	CHF sans TVA
65	2x14		55	10x22	---	---	72 30	5102 DS 06.51	10.90	5105 DS 06.51	17.00	5102 DS 06.51-A	20.90	5105 DS 06.51-A	27.40	5102 DS 06.51-C	14.80	5105 DS 06.51-C	19.80
65	2x14		55	10x30	---	---	72 30	5102 DS 06.50	11.20	5105 DS 06.50	17.40	5102 DS 06.50-A	21.40	5105 DS 06.50-A	27.80	5102 DS 06.50-C	15.20	5105 DS 06.50-C	20.30
65	2x14		55	11x22	---	---	72 30	5102 DS 06.55	10.90	5105 DS 06.55	17.00	5102 DS 06.55-A	20.90	5105 DS 06.55-A	27.40	5102 DS 06.55-C	14.80	5105 DS 06.55-C	19.80
100	2x17		100	11x22	---	---	120 40	5102 DS 10.55	41.20	5105 DS 10.55	60.00	5102 DS 10.55-A	58.40	5105 DS 10.55-A	69.40	5102 DS 10.55-C	53.50	5105 DS 10.55-C	75.70
125	2x17		110	11x22	---	---	145 40	5102 DS 12.55	77.40	5105 DS 12.55	92.10	sur demande auf Anfrage		---	---	---	---	---	---

POLYURÉTHANE								ROUE PIVOTANTE LENKROLLE RUOTA GIREVOLE		PIVOTANT/FREIN LENKROLLE/BREMS GIREVOLE/FRENO		ROUE PIVOTANTE LENKROLLE RUOTA GIREVOLE		PIVOTANT/FREIN LENKROLLE/BREMS GIREVOLE/FRENO		ROUE PIVOTANTE LENKROLLE RUOTA GIREVOLE		PIVOTANT/FREIN LENKROLLE/BREMS GIREVOLE/FRENO	
mm	mm	Page 1.6	kg	mm	mm	mm	mm	Art. N :	CHF sans TVA	Art. N :	CHF sans TVA	Art. N :	CHF sans TVA	Art. N :	CHF sans TVA	Art. N :	CHF sans TVA	Art. N :	CHF sans TVA
65	2x14		55	38x38	25x25 29x29	5.2	78 30	5102 DS 06.60	11.60	5105 DS 06.60	18.00	5102 DS 06.60-A	21.60	5105 DS 06.60-A	28.60	5102 DS 06.60-C	15.20	5105 DS 06.60-C	20.60
65	2x14		55	42x42	28x28 32x32	5.2	78 30	5102 DS 06.61	12.90	5105 DS 06.61	19.40	5102 DS 06.61-A	23.00	5105 DS 06.61-A	29.90	5102 DS 06.61-C	16.50	5105 DS 06.61-C	22.00
65	2x14		55	55x55	40x40 42x42	6.2	78 30	5102 DS 06.62	15.50	5105 DS 06.62	22.00	5102 DS 06.62-A	25.50	5105 DS 06.62-A	32.50	5102 DS 06.62-C	19.00	5105 DS 06.62-C	24.50
100	2x17		100	55x55	40x40 42x42	6.2	124 40	5102 DS 10.62	46.30	5105 DS 10.62	65.10	5102 DS 10.62-A	63.40	5105 DS 10.62-A	74.50	5102 DS 10.62-C	61.30	5105 DS 10.62-C	83.40
125	2x17		110	55x55	40x40 42x42	6.2	147 40	5102 DS 12.62	81.20	5105 DS 12.62	95.90	sur demande auf Anfrage		---	---	---	---	---	---

Variantes / Varianten / Varianti Ø 50-65mm



PARQUET BOIS  
HOLZ-PARKETT  
PARQUET

CARRELAGE  
FLIESEN  
PIASTRELLE

LINO  
LINOLEUM  
LINOLEUM

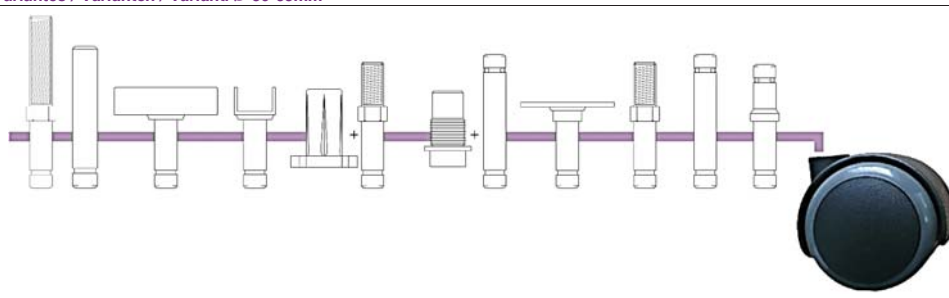

**RABAIS / RABATT / SCONTO : 20% dès/ab/da 100.-- (CHF) / 25% dès/ab/da 500.-- (CHF)**  
RABAIS DE QUANTITE SUR DEMANDE ! MENGENRABATT AUF ANFRAGE ! SCONTO DI QUANTITÀ SU RICHIESTA !



PIVOTEMENT SUR SIMPLE RANGÉE DE BILLES  
ROUE À PALIER LISSE

SCHWENKLAGER MIT EINFACHEM KUGELKRANZ  
RAD MIT GLEITLAGER

PIROETTAMENTO SU SEMPLICE CORONA DI SFERE  
RUOTA A FORO LISCIO

40 - 110 kg

**ANTIMICROBIEN +BioCote®**

Roue Polyuréthane injecté, Antimicrobien gris/vert, roue à palier lisse, non-tachant, silencieux  
corps/roue: Polyamide, support en Polyamide  
roulette jumelée avec fixation à vis/tige lisse/plaque

BioCote® réduit le niveau de microbes sur une surface  
DESTINÉE AUX MAISONS DE SOINS, HOMES ET HÔPITAUX

**ANTIMIKROBIELLE +BioCote®**





Rad mit Spritzguss-Polyurethan, Antimikrobielle grau/grün, Rad mit Gleitlager, spurfrei, Laufruhe  
Radkörper: Polyamid, Gehäuse aus Polyamid  
Zwilling/Lenkrolle mit Befestigung -Schraube/Stift/Platte

BioCote® reduziert das Mikrobenniveau auf einer Oberfläche  
EMPFOHLEN FÜR KRANKENHÄUSERN, PFEGEHEIMEN UND SPITAL





**ANTIMICROBIANE +BioCote®**



Ruota in Poliuretano iniettato, Antimicrobiana grigia/verdi ruota a foro liscio, antiraccia, silenziosa,  
corpo centrale: Poliammide, supporti in Poliammide  
rotelle gemellate con fissazioni a vite/perno liso/piastra

BioCote® riduce il livello di microbi su una superficie  
DESTINATA ALLE CASE DI CURE, HOMES ED OSPEDALI

								ROUE PIVOTANTE LENKROLLE RUOTA GIREVOLE	PIVOTANT/FREIN LENKROLLE/BREMS GIREVOLE/FRENO	ROUE PIVOTANTE LENKROLLE RUOTA GIREVOLE	PIVOTANT/FREIN LENKROLLE/BREMS GIREVOLE/FRENO				
mm	mm	Page 1.6	kg	mm	mm	mm	mm	 Prix Preis Prezzo	 Prix Preis Prezzo	 Prix Preis Prezzo	 Prix Preis Prezzo				
								Art. N :	CHF sans TVA	Art. N :	CHF sans TVA	Art. N :	CHF sans TVA	Art. N :	CHF sans TVA
								ANTIMICROBIEN	ANTIMICROBIEN	ANTISTATIC	ANTISTATIC				
50	2x11		40	M8x15	---	---	60	21	5102 MS 05.78	10.40	5105 MS 05.78	16.90	sur demande auf Anfrage	sur demande auf Anfrage	
50	2x11		40	M10x15	---	---	60	21	5102 MS 05.71	10.40	5105 MS 05.71	16.90	sur demande auf Anfrage	sur demande auf Anfrage	
65	2x14		55	M8x15	---	---	72	30	5102 MS 06.78	13.90	5105 MS 06.78	22.60	sur demande auf Anfrage	sur demande auf Anfrage	
65	2x14		55	M10x15	---	---	72	30	5102 MS 06.71	13.90	5105 MS 06.71	22.60	sur demande auf Anfrage	sur demande auf Anfrage	
100	2x17		100	M10x20	---	---	120	40	5102 MS 10.71	50.50	5105 MS 10.71	71.50	sur demande auf Anfrage	sur demande auf Anfrage	
100	2x17		100	M12x20	---	---	120	40	5102 MS 10.72	51.00	5105 MS 10.72	72.00	sur demande auf Anfrage	sur demande auf Anfrage	
A) 125	2x17		110	M10x20	---	---	145	40	5102 MS 12.71	86.10	5105 MS 12.71	102.40	sur demande auf Anfrage	sur demande auf Anfrage	

A) AUSSI AVEC VIS M12x20mm, +CHF 3.00 / AUCH MIT SCHRAUBE M12x20mm, +CHF 3.00 / ANCHE CON VITE M12x20mm, +CHF 3.00

								 Prix Preis Prezzo	 Prix Preis Prezzo	 Prix Preis Prezzo	 Prix Preis Prezzo				
mm	mm	Page 1.6	kg	mm	mm	mm	mm	Art. N :	CHF sans TVA	Art. N :	CHF sans TVA	Art. N :	CHF sans TVA	Art. N :	CHF sans TVA
								ANTIMICROBIEN	ANTIMICROBIEN	ANTISTATIC	ANTISTATIC				
50	2x11		40	10x22	---	---	60	21	5102 MS 05.51	11.10	5105 MS 05.51	17.40	sur demande auf Anfrage	sur demande auf Anfrage	
50	2x11		40	10x30	---	---	60	21	5102 MS 05.50	11.40	5105 MS 05.50	17.80	sur demande auf Anfrage	sur demande auf Anfrage	
50	2x11		40	11x22	---	---	60	21	5102 MS 05.55	11.10	5105 MS 05.55	17.40	sur demande auf Anfrage	sur demande auf Anfrage	
65	2x14		55	10x22	---	---	72	30	5102 MS 06.51	14.60	5105 MS 06.51	23.20	sur demande auf Anfrage	sur demande auf Anfrage	
65	2x14		55	10x30	---	---	72	30	5102 MS 06.50	14.90	5105 MS 06.50	23.50	sur demande auf Anfrage	sur demande auf Anfrage	
65	2x14		55	11x22	---	---	72	30	5102 MS 06.55	14.60	5105 MS 06.55	23.20	sur demande auf Anfrage	sur demande auf Anfrage	
100	2x17		100	11x22	---	---	120	40	5102 MS 10.55	51.00	5105 MS 10.55	72.00	sur demande auf Anfrage	sur demande auf Anfrage	
125	2x17		110	11x22	---	---	145	40	5102 MS 12.55	86.70	5105 MS 12.55	102.80	sur demande auf Anfrage	sur demande auf Anfrage	

								 Prix Preis Prezzo	 Prix Preis Prezzo	 Prix Preis Prezzo	 Prix Preis Prezzo				
mm	mm	Page 1.6	kg	mm	mm	mm	mm	Art. N :	CHF sans TVA	Art. N :	CHF sans TVA	Art. N :	CHF sans TVA	Art. N :	CHF sans TVA
								ANTIMICROBIEN	ANTIMICROBIEN	ANTISTATIC	ANTISTATIC				
A) 50	2x11		40	38x38	25x25 29x29	5.2	62	21	5102 MS 05.60	11.60	5105 MS 05.60	18.00	sur demande auf Anfrage	sur demande auf Anfrage	
65	2x14		55	38x38	25x25 29x29	5.2	78	30	5102 MS 06.60	15.10	5105 MS 06.60	24.30	sur demande auf Anfrage	sur demande auf Anfrage	
65	2x14		55	42x42	28x28 32x32	5.2	78	30	5102 MS 06.61	16.40	5105 MS 06.61	25.60	sur demande auf Anfrage	sur demande auf Anfrage	
65	2x14		55	55x55	40x40 42x42	6.2	78	30	5102 MS 06.62	18.90	5105 MS 06.62	28.20	sur demande auf Anfrage	sur demande auf Anfrage	
100	2x17		100	55x55	40x40 42x42	6.2	126	40	5102 MS 10.62	58.40	5105 MS 10.62	79.30	sur demande auf Anfrage	sur demande auf Anfrage	
125	2x17		110	55x55	40x40 42x42	6.2	147	40	5102 MS 12.62	91.60	5105 MS 12.62	107.60	sur demande auf Anfrage	sur demande auf Anfrage	

A) AUTRES PLAQUES DISPONIBLES / ANDERE VERFÜGBAREN PLATTE / ALTRE PIASTRA DISPONIBILI : 42x42mm +CHF 1.00, 55x55mm +CHF 3.00

**ROULETTES POUR MEUBLES ET APPAREILS**

PIVOTEMENT SUR SIMPLE RANGÉE DE BILLES  
ROUE À PALIER LISSE

**MÖBEL- UND APPARATE-ROLLEN**

SCHWENKLAGER MIT EINFACHEM KUGELKRANZ  
RAD MIT GLEITLAGER

**RUOTE PER MOBILI ED APPARECCHI**

PIROETTAMENTO SU SEMPLICE CORONA DI SFERE  
RUOTA A FORO LISCIO

**ROULETTES ANTIMICROBIENNES / ANTIMIKROBIELLE ROLLEN / ROTELLE ANTIMICROBIANE / ANTIMICROBIAL CASTORS**

- **BioCote®** : Une substance antimicrobienne qui empêche le développement et la survie de microbes, y compris les bactéries et les moisissures.  
**Elle accroît l'hygiène d'un produit**, quand il est susceptible d'abriter des microbes nuisibles à la santé humaine.
- **BioCote®** : Als 'antimikrobiell' bezeichnet man die Eigenschaft, das Wachstum und den Befall durch Mikroben, Bakterien und Schimmelpilzen zu verhindern.  
**Sie erhöht die hygienischen Eigenschaften der Produkte**, die aller Wahrscheinlichkeit nach von krank machenden Mikroben kolonisiert sind.
- **BioCote®** : Una protezione antimicrobica previene la crescita e sopravvivenza di microbi inclusi batteri, muffe e funghi.  
**Rende un prodotto più igienico**, in presenza di microbi dannosi per la salute umana
- **BioCote®** : An antimicrobial substance is something which prevents the development and the survival of germs, including bacteria and molds  
**It increases the hygiene of a product**, when it may shelter germs harmful to the human health

**1**

■ **Les microbes contaminent la surface de la roulette protégée par BioCote®**

■ **Mikroben auf der Oberfläche der Rolle unter dem Schutz BioCote®**

■ **I microbi contaminano la superficie della rotelle protetta da BioCote®**

■ **Microbes colonise surface of BioCote® protected castor**

**2**

■ **Les ions d'argent sont prêts à agir contre les bactéries contaminantes**

■ **Silberionen kommen mit den Mikroben in Berührung**

■ **Gli ioni di argento sono pronti ad agire contro i batteri contaminati**

■ **Silver ions are available to act against colonising microbes**

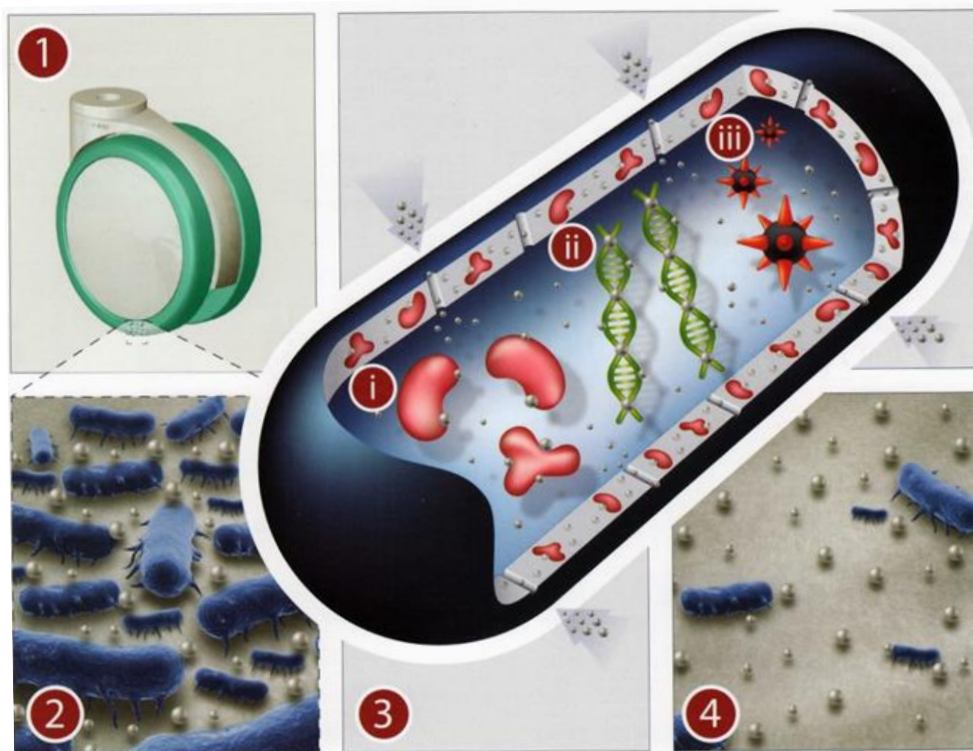
**3**

■ **Les ions d'argent agissent contre les bactéries de 3 façons:**

- i Les ions d'argent s'associent avec les protéines intracellulaires et les protéines de la paroi cellulaire des bactéries
- ii Les ions d'argent interfèrent avec la réplication de l'ADN
- iii Les ions d'argent entraînent la formation d'espèces réactives

■ **Die Mikroben werden in 3 Phasen angegriffen:**

- i Silberionen verbinden sich mit Proteinen in Zellenwand und der Zelle
- ii Silberionen greifen die DNS Fortpflanzung an
- iii Silberionen regen Sauerstoffradikale in der Zelle an

■ **Gli ioni di argento agiscono contro i batteri di 3 modi:**

- i Gli ioni di argento si associano con le proteine intracellulari e le proteine della parete cellulare dei batteri
- ii Gli ioni di argento interferiscono col réplacation del DNA
- iii Gli ioni di argento trascinano la formazione di specie reattive

■ **Silver ions act against microbes in 3 ways:**

- i Silver ions combine with microbe proteins in the cell and cell wall
- ii Silver ions interfere with DNA replication
- iii Silver ions promote formation of reactive oxygen species

**4**

■ **Les bactéries meurent, et la roulette est plus propre et plus hygiénique**

■ **Die Bakterien sterben, und die Rolle ist sauberer und hygienischer**

■ **I batteri muoiono, e la rotelle è più proprio e più igienico**

■ **Bacteria die, and the castor is cleaner and more hygienic**

**RABAIS / RABATT / SCONTO : 20% dès/ab/da 100.-- (CHF) / 25% dès/ab/da 500.-- (CHF)**  
RABAIS DE QUANTITE SUR DEMANDE ! MENGENRABATT AUF ANFRAGE ! SCONTO DI QUANTITA SU RICHIESTA !

**ROULETTES POUR MEUBLES ET APPAREILS**

PIVOTEMENT SUR SIMPLE RANGÉE DE BILLES  
ROUE À PALIER LISSE

**MÖBEL- UND APPARATE-ROLLEN**

SCHWENKLAGER MIT EINFACHEM KUGELKRANZ  
RAD MIT GLEITLAGER

**RUOTE PER MOBILI ED APPARECCHI**

PIROETTAMENTO SU SEMPLICE CORONA DI SFERE  
RUOTA A FORO LISCIO

**ROULETTES ANTIMICROBIENNES AVEC LA TECHNOLOGIE BioCote®**

Destinées aux maisons de soins, homes, aux hôpitaux et aux autres environnements dans lesquels la protection des surfaces contre les microbes est importante, les roulettes antimicrobiennes comportent la technologie d'ions d'argent BioCote® :

- Inhibe la prolifération de bactéries, moisissures et champignons, perturbant leurs fonctions cellulaires normales et arrêtant leur multiplication
- Commence à avoir de l'effet après seulement 15 minutes
- Réduit les niveaux de contamination bactérienne sur les surfaces traitées jusqu'à 99% dans un délai de 2 heures
- Ne sera pas effacée ou enlevée par le nettoyage, car l'additif antimicrobien est intégré dans les bandes souples et la pédale de frein de la roulette lors de la fabrication

BioCote® est une marque déposée de BioCote Ltd. La technologie BioCote® ne remplace pas le nettoyage. Ce produit comporte la technologie antimicrobienne sous forme de verre de phosphate d'argent pour préserver la surface et prévenir la dégradation provoquée par la prolifération de microbes.

**ANTIMIKROBIELLE ROLLEN MIT BioCote® TECHNOLOGIE**

Überall da wo Schutz vor Keimen, Bakterien, Viren und Schimmel an oberster Stelle steht. In Krankenhäusern, Pflegeheimen und Spital hilft die Rollenserie mit BioCote® antimikrobiellen Silberionen :

- Silberionen bekämpfen Viren, Bakterien und Schimmel, in dem sie die normalen Zellenfunktionen stören und somit deren Fortpflanzung und Verbreitung unterbinden
- Die Wirkung der Silberionen kann schon nach 15 Minuten nachgewiesen werden
- Nach 2 Stunden ist ein Mikobenzugang von bis zu 99% erkennbar
- Es handelt sich nicht um eine einfache Beschichtung, die Wirkung der Silberionen nutzt nicht ab da es vor der Produktion der Rolle im Kunststoffgemisch des Rades und des Bremshebels mitinkorporiert wird

BioCote® ist ein eingetragenes Warenzeichen Marke der BioCote Ltd. Die Technologie BioCote® ersetzt keine Reinigung. Dieses Produkt fasst die mikrobienhemmende Technologie in Form von Glas von Silberphosphat um, um die Oberfläche zu schützen und die durch die Wucherung von Mikroben verursachte Degradierung vorzubeugen.

**ROTELLE ANTIMICROBIANE CON IL TECNOLOGIA BioCote®**

Destinate alle case di cure, homes, agli ospedali ed agli altri ambienti naturali in che la protezione delle superfici contro i microbi è importante, i roulette antimicrobiennes comportano la tecnologia di ioni di argento BioCote® :

- Inibisci la proliferazione di batteri, muffe e funghi, che perturbano le loro funzioni cellulari normale e fermando la loro moltiplicazione
- Comincia ad avere dell'effetto dopo solamente 15 minuti
- Ridotto i livelli di contaminazione batterica sulle superfici trattate fino al 99% entro le 2 ore
- Non sarà cancellata tolta o dalla pulizia, perché l'additivo antimicrobien è integrato nelle bande agili ed il pedale di freno della roulette all'epoca della fabbricazione

BioCote® è una marca depositata di BioCote Ltd. Il tecnologia BioCote® non sostituisce la pulizia. Questo prodotto comporta il tecnologia antimicrobienne sotto forma di bicchiere di fosfato di argento per preservare la superficie ed avvertire la degradazione provocata dalla proliferazione di microbi.

**ANTIMICROBIAL CASTORS WITH BioCote® TECHNOLOGY**

Designed for use in care homes, hospitals and other environments where surface protection from microbes is important, antimicrobial castors incorporate BioCote® silver ion technology :

- Inhibits the growth of microbes such as odour causing and staining bacteria, moulds and fungi, disrupting the normal cell function of microbes and stopping them from reproducing
- Starts to have an effect after just 15 minutes
- Reduces the level of microbes on the treated surface by up to 99% in 2 hours
- Will not wear off or wash away, because the antimicrobial additive is incorporated into the castor tyre and pedal at the time of manufacture

BioCote® is a registered trademark of BioCote Ltd. The BioCote® technology does not replace the cleaning. This product contains the antimicrobial technology in the form of glass of phosphate of silver to protect the surface and prevent the degradation caused by the proliferation of germs.



**HÔPITAL**  
SPITAL  
OSPEDALE



**SALLE POLYVALENTE**  
MEHRZWECKHALLE  
CENTRO SPORTIVO



**AMENAGEMENT**  
EINRICHTUNG  
ARREDAMENTO



**CUISINE**  
KÜCHE  
CUCINA



**ALIMENTATION**  
LEBENSMITTEL  
ALIMENTAZIONE





**ROULETTES POUR MEUBLES ET APPAREILS**PIVOTEMENT SUR SIMPLE RANGÉE DE BILLES  
ROUE À PALIER LISSE**MÖBEL- UND APPARATE-ROLLEN**SCHWENKLAGER MIT EINFACHEM KUGELKRANZ  
RAD MIT GLEITLAGER**RUOTE PER MOBILI ED APPARECCHI**PIROETTAMENTO SU SEMPLICE CORONA DI SFERE  
RUOTA A FORO LISCIO

&gt;&gt; PAGE / SEITE / PAGINA &gt;2.9 + 3.13 + 4.7 + 5.21

**RABAIS SPÉCIAL 20%****SET-BUREAU** (5 pces, au choix)**SPEZIAL-RABATT 20%****SET-BÜRO** (5 Stk, nach wahl)**SCONTO SPECIALE 20%****SET-UFFICIO** (5 pz, a scelta)A  
C  
T  
I  
O  
N**ROUES POUR CHAISE DE BUREAU** (pour sols durs/mous)**RÄDER FÜR BÜRO-STUHL** (für harte/weiche Boden)**RUOTE PER SEDIA DI UFFICIO** (per i pavimenti duri/molli)

ROUE PIVOTANTE LENKROLLE RUOTA GIREVOLE							PIVOTANT/FREIN LENKROLLE/BREMS GIREVOLE/FRENO		ROUE PIVOTANTE LENKROLLE RUOTA GIREVOLE		PIVOTANT/FREIN LENKROLLE/BREMS GIREVOLE/FRENO		ROUE PIVOTANTE LENKROLLE RUOTA GIREVOLE		PIVOTANT/FREIN LENKROLLE/BREMS GIREVOLE/FRENO	
mm	mm	Page 1.6	kg	mm	mm	mm	Art. N :	CHF sans TVA	Art. N :	CHF sans TVA	Art. N :	CHF sans TVA	Art. N :	CHF sans TVA	Art. N :	CHF sans TVA
POLYURÉTHANE							POLYURÉTHANE		POLYURÉTHANE		CAOUTCHOUC		POLYAMIDE		POLYAMIDE	
50	2x11		40	10x22	60	21	5102 DS 05.51	8.70	5002 DS 05.51	10.30	---	---	---	---	5102 PS 05.51	5.40
50	2x11		40	10x30	60	21	5102 DS 05.50	9.10	5002 DS 05.50	10.90	5012 DS 05.50	19.90	4700 G 05.50	22.40	5102 PS 05.50	5.80
50	2x11		40	11x22	60	21	5102 DS 05.55	8.70	5002 DS 05.55	10.30	5012 DS 05.55	23.70	4700 G 05.55	26.10	5102 PS 05.55	5.40
50	2x11		40	10x22	60	21	5102 DS 05.51	8.70	5002 DS 05.51	10.30	---	---	---	---	5102 PS 05.51	5.40
50	2x11		40	10x30	60	21	5102 DS 05.50	9.10	5002 DS 05.50	10.90	5012 DS 05.50	19.90	4700 G 05.50	22.40	5102 PS 05.50	5.80
50	2x11		40	11x22	60	21	5102 DS 05.55	8.70	5002 DS 05.55	10.30	5012 DS 05.55	23.70	4700 G 05.55	26.10	5102 PS 05.55	20.30

POLYURÉTHANE + CAOUTCHOUC = POUR SOLS DURS / POLYURETHAN + GUMMI = FÜR HARTE BODEN / POLYURETANO + GOMMA = PER I PAVIMENTI DURI  
POLYAMIDE/NYLON = POUR SOLS MOUS / POLYAMIDE/NYLON = FÜR WEICHE BODEN / POLIAMMIDE/NYLON = PER I PAVIMENTI MOLLI  
AUTRES GRANDEURS DISPONIBLES, page 2.1-3 / ANDERE VERFÜGBAREN GRÖßEN, Seite 2.1-3 / ALTRE DIMENSIONI DISPONIBILI, pagina 2.1-3

&gt;&gt; PAGE / SEITE / PAGINA &gt;2.9 + 3.13 + 4.7 + 5.21

**RABAIS SPÉCIAL 20-25%****SET-STATIF** (5 pces, au choix)**SPEZIAL-RABATT 20-25%****SET-STATIF** (5 Stk, nach wahl)**SCONTO SPECIALE 20-25%****SET-STATIF** (5 pz, a scelta)A  
C  
T  
I  
O  
N**ROUES POUR STATIF** (Home et Hôpital)**RÄDER FÜR STATIF** (Heim und Spital)**RUOTE PER STATIF** (Collettività e Ospedale)

ROUE PIVOTANTE LENKROLLE RUOTA GIREVOLE							ROUE PIVOTANTE LENKROLLE RUOTA GIREVOLE		ROUE PIVOTANTE LENKROLLE RUOTA GIREVOLE							ROUE PIVOTANTE LENKROLLE RUOTA GIREVOLE				
mm	mm	Page 1.6	kg	mm	mm	mm	Art. N :	CHF sans TVA	Art. N :	CHF sans TVA	mm	mm	Page 1.6	kg	mm	mm	Art. N :	CHF sans TVA	Art. N :	CHF sans TVA
POLYURÉTHANE							ANTISTATIC		ANTIMICROBIEN							CHROMÉ				
50	2x11		40	A) 10x22	60		5102 DS 05.51	10.10	5102 DS 05.51-A	20.50	50	2x11		40	A) 10x22	60	5102 MS 05.51	11.10	---	---
60	2x14		55	A) 10x22	60		5102 DS 06.51	10.90	5102 DS 06.51-A	20.90	60	2x14		55	A) 10x22	60	5102 MS 06.51	14.60	5102 DS 06.51-C	14.80

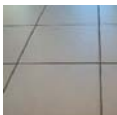
A) AUTRES FIXATIONS DISPONIBLES / ANDERE VERFÜGBAREN BEFESTIGUNG / ALTRE ATTACCO DISPONIBILI  
AUTRES GRANDEURS DISPONIBLES, page 2.1-3, 3.1-6 / ANDERE VERFÜGBAREN GRÖßEN, Seite 2.1-3, 3.1-6 / ALTRE DIMENSIONI DISPONIBILI, pagina 2.1-3, 3.1-6PARQUET BOIS  
HOLZ-PARKETT  
PARQUETINDUSTRIE  
INDUSTRIE  
INDUSTRIACARRELAGE  
FLIESEN  
PIASTRELLEDOUILLE POLYAMIDE, CARRÉ > PAGE 7.19  
POLYAMID-HÜLSEN, VIERKANT > SEITE 7.19  
POLIAMMIDE ADATTATORE, QUADRO > PAG. 7.19DOUILLE POLYAMIDE, ROND > PAGE 7.19  
POLYAMID-HÜLSEN, RUND > SEITE 7.19  
POLIAMMIDE ADATTATORE, TONDO > PAG. 7.19



# ROULETTES POUR APPAREILS

## APPARATE-ROLLEN

### RUOTE PER APPARECCHI

# 3



50 – 120 kg



50 - 200 mm

SECTEURS / BEREICHE / SETTORI



INDEX / INHALT / INDICE



**PAGE 3.1-2**  
CAOUTCH-  
THER  
GUMMI-THERMO  
GOMMA-TERMO



**PAGE 3.3**  
CAOUTCHOUC  
GUMMI  
GOMMA



**PAGE 3.3**  
PNEU-SOFT  
SOFT-REIFEN  
PNEU-SOFT

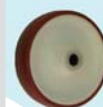

**PAGE 3.4**  
POLYURETHANE  
POLYURETHAN  
POLIURETANO



**PAGE 3.5-7**  
POLYURETHANE  
POLYURETHAN  
POLIURETANO



**PAGE 3.6**  
ANTISTATIQUE  
ANTISTATISCH  
ANTISTATICO



**PAGE 3.7-8**  
POLYAMIDE  
POLYAMID  
POLIAMMIDE



**PAGE 3.7-8**  
POLYAMIDE  
POLYAMID  
POLIAMMIDE



**PAGE 3.9**  
CAOUTCHOUC  
GUMMI  
GOMMA



**PAGE 3.9**  
POLYURETHANE  
POLYURETHAN  
POLIURETANO



**PAGE 3.11**  
CAOUTCH-  
THER  
GUMMI-THERMO  
GOMMA-TERMO



**PAGE 3.11**  
PNEU-SOFT  
SOFT-REIFEN  
PNEU-SOFT



**PAGE 3.12**  
POLYURETHANE  
POLYURETHAN  
POLIURETANO



**PAGE 3.12**  
ANTISTATIQUE  
ANTISTATISCH  
ANTISTATICO



**PAGE 3.13**  
ACTION - AKTION  
ACTION.MARKET  
AKTION.MARKET



**PAGE 3.13**  
ACTION.ROULANT  
AKTION.ROLLSTUH  
ACTION.CARROZZ



**ROULETTES POUR APPAREILS ET HÔPITAUX**

SUPPORT EN ACIER, ZINGUÉ-PROMATISÉ  
PIVOTEMENT SUR DOUBLE RANGÉE DE BILLES  
ROUE À PALIER LISSE, ROUEMENT À ROULEAUX OU À BILLES

**APPARATE- UND SPITAL-ROLLEN**

GEHÄUSE AUS STAHLBLECH, VERZINKT-PROMATISIERT  
SCHWENKLAGER MIT ZWEIFACHEM KUGELKRANZ  
RAD MIT GLEITLAGER, ROLLENLAGER ODER KUGELLAGER

**RUOTE PER ARREDAMENTO ED OSPEDALI**

SUPPORTI IN LAMIERA D'ACCIAIO, ZINCATO-CROMATO  
PIROETTAMENTO A DOPPIA CORONA DI SFERE  
RUOTA A FORO LISCIO, SU CUSCINETTO A RULLI E A SFERE

50 – 90 kg

**CAOUTCHOUC/Thermoplastique**

Roue Caoutchouc Thermoplastique, gris, roue à palier lisse ou avec roulement à billes, non-tachant, silencieux, corps/roue: Nylon renforcé de fibres de verre

RECOMMANDÉ POUR LES CUISINES, LES HOPITAUX ET LES AGENCEMENTS

**GUMMI/Thermoplastisch**

Gummirad Thermoplastisch, grau, Rad mit Gleitlager oder Kugellager, spurfrei, Laufruhe, Radkörper: Nylon und Glasfaser Verbindung

EMPFOHLEN FÜR DIE KÜCHEN, DIE SPITÄLER UND DIE EINRICHTUNGEN

**GOMMA/Termoplastica**

Ruota in Gomma Termoplastica, grigia, ruota a foro liscio o su cuscinetti a sfere, antitraccia, silenziosa, corpo centrale: Nylon rinforzato con fibre di vetro

RACCOMANDATÒ PER LE CUCINE, OSPEDALI E PER ARREDAMENTO

Secteurs / Bereiche / Settori



HOPITAL  
SPITAL  
OSPEDALE



CUISINE  
KÜCHE  
CUCINA

Applications / Anwendung / Applicazioni



CARRELAGE  
FLIESEN  
PIASTRELLE



PARQUET BOIS  
HOLZ-PARKETT  
PARQUET

INDUSTRIE  
INDUSTRIE  
INDUSTRIA

Variantes / Varianten / Varianti



-20° - +80° C  
87 Sh/A



ROUE  
PAGE 7.1  
50 – 310 kg



SERIE H..  
PAGE 3.11  
100 – 120 kg



SERIE 5.-8..  
PAGE 5.1  
90 – 310 kg

AVEC PLAQUE / MIT PLATTE / A PIASTRA

AVEC TROU / MIT LOCH / A FORO

										ROUE PIVOTANTE LENKROLLE RUOTA GIREVOLE		PIVOTANT/FREIN LENKROLLE/BREMS GIREVOLE/FRENO		ROUE FIXE BOCKROLLE RUOTA FISSA												ROUE PIVOTANTE LENKROLLE RUOTA GIREVOLE		PIVOTANT/FREIN LENKROLLE/BREMS GIREVOLE/FRENO	
											Prix Preis Prezzo		Prix Preis Prezzo		Prix Preis Prezzo												Prix Preis Prezzo		Prix Preis Prezzo
										Art. N :	CHF sans TVA	Art. N :	CHF sans TVA	Art. N :	CHF sans TVA											Art. N :	CHF sans TVA	Art. N :	CHF sans TVA
<b>ZINGUÉ_SERIE N° 3 'LEGER' (page 1.8)</b>																													
A)	50	19		50	B)	60x60	B)	39x39 48x48	6.2	71	25	3111.05	10.50	3211.05	13.40	3311.05	8.30	10.2	3011.05	9.40	3711.05	12.70							
	50	19		50	B)	60x60	B)	39x39 48x48	6.2	71	25	3113.05	14.60	3213.05	17.00	3313.05	12.50	10.2	3013.05	13.10	3713.05	16.40							
A)	60	25		60	C)	60x60	C)	39x39 48x48	6.2	82	25	3111.06	12.50	3211.06	16.50	3311.06	9.50	10.2	3011.06	10.90	3711.06	14.80							
	60	25		60	C)	60x60	C)	39x39 48x48	6.2	82	25	3113.06	16.80	3213.06	19.80	3313.06	14.30	10.2	3013.06	15.50	3713.06	18.60							
A)	75	25		60	C)	60x60	C)	39x39 48x48	6.2	97	30	3111.07	14.30	3211.07	18.60	3311.07	10.90	10.2	3011.07	13.10	3711.07	17.00							
	75	25		60	C)	60x60	C)	39x39 48x48	6.2	97	30	3113.07	19.20	3213.07	22.60	3313.07	16.50	10.2	3013.07	17.50	3713.07	21.40							
	80	25		70	C)	60x60	C)	39x39 48x48	6.2	100	30	3113.08	20.40	3213.08	23.90	3313.08	17.40	10.2	3013.08	19.40	3713.08	22.50							
D)	80	25		70	C)	60x60	C)	39x39 48x48	6.2	100	30	3113.08-S	24.20	3213.08-S	27.70	3313.08-S	21.30	10.2	3013.08-S	23.20	3713.08-S	26.40							
A)	100	25		80	C)	60x60	C)	39x39 48x48	6.2	121	32	3111.10	18.00	3211.10	22.10	3311.10	15.20	10.2	3011.10	16.60	3711.10	21.40							
	100	25		80	C)	60x60	C)	39x39 48x48	6.2	121	32	3113.10	23.90	3213.10	27.70	3313.10	21.30	10.2	3013.10	22.50	3713.10	26.80							
A)	125	25		90	C)	60x60	C)	39x39 48x48	6.2	148	35	3111.12	22.10	3211.12	26.00	---	---	10.2	3011.12	20.90	3711.12	25.00							
	125	25		90	C)	60x60	C)	39x39 48x48	6.2	148	35	3113.12	27.70	3213.12	31.60	---	---	10.2	3013.12	26.80	3713.12	30.20							

<b>INOX_SERIE N° 3 'LEGER' (page 1.8)</b>										<b>INOX / ROSTFREI / INOX</b>										<b>INOX / ROSTFREI / INOX</b>									
60	25		70	65x65	40x40 50x50	6.5	F)	86	26 / 37	X-3113.06	36.60	X-3213.06	45.60	sur demande auf Anfrage	---	E)	12.3	X-3013.06	30.10	X-3713.06	38.90								
80	25		70	65x65	40x40 50x50	6.5	F)	108	38 / 37	X-3113.08	41.20	X-3213.08	50.50	sur demande auf Anfrage	---	E)	12.3	X-3013.08	34.80	X-3713.08	43.80								
A)	100	25		80	65x65	40x40 50x50	6.5	F)	130	38 / 35	X-3111.10	37.10	X-3211.10	46.10	sur demande auf Anfrage	---	E)	12.3	X-3011.10	30.60	X-3711.10	39.40							
	100	25		80	65x65	40x40 50x50	6.5	F)	130	38 / 35	X-3113.10	46.40	X-3213.10	55.40	sur demande auf Anfrage	---	E)	12.3	X-3013.10	39.80	X-3713.10	48.70							
A)	125	25		90	65x65	40x40 50x50	6.5	F)	158	38 / 35	X-3111.12	39.80	X-3211.12	49.30	sur demande auf Anfrage	---	E)	12.3	X-3011.12	33.60	X-3711.12	42.70							
	125	25		90	65x65	40x40 50x50	6.5	F)	158	38 / 35	X-3113.12	51.60	X-3213.12	61.50	sur demande auf Anfrage	---	E)	12.3	X-3013.12	45.80	X-3713.12	55.10							

A) ROUE SANS PARE-FILES / RAD OHNE FADENSCHUTZ / RUOTA SENZA PARAFILI  
 B) ROULETTE FIXE, PLAQUE / BOCKROLLE, PLATTE / RUOTA FISSA, PIASTRA: 55x55mm – 39x39 / 45x45mm  
 C) ROULETTE FIXE, PLAQUE / BOCKROLLE, PLATTE / RUOTA FISSA, PIASTRA: 67.5x60mm – 39x39 / 48x48mm  
 D) AVEC CAOUTCHOUC-ELASTIQUE 75 Sh/A / MIT ELASTISCHE-GUMMI 75 Sh/A / CON GOMMA-ELASTIK 75 Sh/A  
 E) EGAGEMENT AVEC TROU 10.2mm / AUCH MIT LOCH 10.2mm / ANCHE A FORO 10.2mm  
 F) ROULETTE AVEC PLAQUE, HAUTEUR +3mm / ROLLEN MIT PLATTE, BAUHÖHE +3mm / RUOTA A PIASTRA, ALTEZZA UTILE +3mm

**ROULETTES POUR APPAREILS ET HÔPITAUX**

SUPPORT EN ACIER, ZINGUÉ-PROMATISÉ  
PIVOTEMENT SUR DOUBLE RANGÉE DE BILLES  
ROUE À PALIER LISSE, ROULEMENT À ROULEAUX OU À BILLES

**APPARATE- UND SPITAL-ROLLEN**

GEHÄUSE AUS STAHLBLECH, VERZINKT-PROMATISIERT  
SCHWENKLAGER MIT ZWEIFACHEM KUGELKRANZ  
RAD MIT GLEITLAGER, ROLLENLAGER ODER KUGELLAGER

**RUOTE PER ARREDAMENTO ED OSPEDALI**

SUPPORTI IN LAMIERA D'ACCIAIO, ZINCATO-CROMATO  
PIROETTAMENTO A DOPPIA CORONA DI SFERE  
RUOTA A FORO LISCIO, SU CUSCINETTO A RULLI E A SFERE

90 – 120 kg

**CAOUTCHOUC/Thermoplastique**

Roue Caoutchouc Thermoplastique, gris, roue à palier lisse ou avec roulement à billes, non-tachant, silencieux, corps/roue: Nylon renforcé de fibres de verre

RECOMMANDÉ POUR LES CUISINES, LES HOPITAUX ET LES AGENCEMENTS

**GUMMI/Thermoplastisch**

Gummirad Thermoplastisch, grau, Rad mit Gleitlager oder Kugellager, spurfrei, Laufruhe, Radkörper: Nylon und Glasfaser verbindung

EMPFOHLEN FÜR DIE KÜCHEN, DIE SPITÄLER UND DIE EINRICHTUNGEN

**GOMMA/Termoplastica**

Ruota in Gomma Termoplastica, grigia, ruota a foro liscio o su cuscinetti a sfere, antitraccia, silenziosa, corpo centrale: Nylon rinforzato con fibre di vetro

RACCOMANDATÒ PER LE CUCINE, OSPEDALI E PER ARREDAMENTO

**Secteurs / Bereiche / Settori**

HOPITAL  
SPITAL  
OSPEDALE



CUISINE  
KÜCHE  
CUCINA

**Applications / Anwendung / Applicazioni**

CARRELAGE  
FLIESEN  
PIASTRELLE

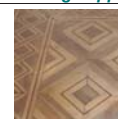

PARQUET BOIS  
HOLZ-PARKETT  
PARQUET



INDUSTRIE  
INDUSTRIE  
INDUSTRIA

**Variantes / Varianten / Varianti**

-20° - +80° C  
87 Sh/A



**ROUE**  
PAGE 7.1  
50 – 310 kg



**SERIE H..**  
PAGE 3.11  
100 – 120 kg



**SERIE 55..**  
PAGE 4.4  
350 – 490 kg



**SERIE 5..-8..**  
PAGE 5.1  
90 – 310 kg

**AVEC PLAQUE / MIT PLATTE / A PIASTRA****AVEC TROU / MIT LOCH / A FORO**

								ROUE PIVOTANTE LENKROLLE RUOTA GIREVOLE		PIVOTANT/FREIN LENKROLLE/BREMS GIREVOLE/FRENO		ROUE FIXE BOCKROLLE RUOTA FISSA		ROUE PIVOTANTE LENKROLLE RUOTA GIREVOLE		PIVOTANT/FREIN LENKROLLE/BREMS GIREVOLE/FRENO				
									Prix Preis Prezzo		Prix Preis Prezzo		Prix Preis Prezzo		Prix Preis Prezzo		Prix Preis Prezzo			
								Art. N :	CHF sans TVA	Art. N :	CHF sans TVA	Art. N :	CHF sans TVA	mm	Art. N :	CHF sans TVA	Art. N :	CHF sans TVA		
<b>ZINGUÉ SERIE N° 2 'MEDIA' (page 1.8)</b>																				
A)	80	32		90	77x67	50x41 61x51	8.3	103	26	2111.08	22.80	2211.08	29.80	2311.08	20.00	10.2	2011.08	20.80	2711.08	27.70
	80	32		90	77x67	50x41 61x51	8.3	103	26	2113.08	26.80	2213.08	34.00	2313.08	24.90	10.2	2013.08	25.50	2713.08	31.80
A)	100	32		100	77x67	50x41 61x51	8.3	124	28	2111.10	26.30	2211.10	34.60	2311.10	23.50	10.2	2011.10	25.10	2711.10	32.90
	100	32		100	77x67	50x41 61x51	8.3	124	28	2113.10	30.90	2213.10	39.00	2313.10	28.20	10.2	2013.10	29.50	2713.10	37.20
B)	100	32		100	77x67	50x41 61x51	8.3	124	28	2113.10-S	34.80	2213.10-S	42.90	2313.10-S	32.00	10.2	2013.10-S	33.40	2713.10-S	41.10
D)	100	32		110	77x67	50x41 61x51	8.3	135	38	2470 PJP 10.60	34.60	2407 PJP 10.60	49.10	2478 PJP 10.60	31.50	C) 10.2	2470 PJP 10.30	33.30	2407 PJP 10.30	47.40
A)	125	32		110	77x67	50x41 61x51	8.3	152	37	2111.12	29.80	2211.12	37.60	2311.12	26.70	10.2	2011.12	27.80	2711.12	36.00
	125	32		110	77x67	50x41 61x51	8.3	152	37	2113.12	36.80	2213.12	44.00	2313.12	33.60	10.2	2013.12	33.50	2713.12	42.90
D)	125	32		120	77x67	50x41 61x51	8.3	161	40	2470 PJP 12.60	41.20	2407 PJP 12.60	58.50	2478 PJP 12.60	37.50	C) 10.2	2470 PJP 12.30	38.30	2407 PJP 12.30	52.40
B)	125	32		110	77x67	50x41 61x51	8.3	152	37	2113.12-S	40.70	2213.12-S	47.90	2313.12-S	37.50	10.2	2013.12-S	37.40	2713.12-S	45.50

A) ROUE SANS PARE-FILES / RAD OHNE FADENSCHUTZ / RUOTA SENZA PARAFILI

B) AVEC CAOUTCHOUC-ELASTIQUE 75 Sh/A / MIT ELASTISCHE-GUMMI 75 Sh/A / CON GOMMA-ELASTIK 75 Sh/A

C) EGALEMENT AVEC TROU 12,3mm / AUCH MIT LOCH 12,3mm / ANCHE A FORO 12,3mm

D) INOX +CHF 25.00

**RABAIS SPÉCIAL 'SET-SUPERMARCHÉ' PAGE 3.9 / SPEZIAL-RABATT 'SET-SUPERMARKET' SEITE 3.9 / SCONTO SPECIALE 'SET-SUPERMARKET' PAGINA 3.9**

	FIXATION, PAGE 7.19 BEFESTIGUNG, SEITE 7.19 FISSAZIONE, PAGINA 7.19
	FIXATION, PAGE 7.19 BEFESTIGUNG, SEITE 7.19 FISSAZIONE, PAGINA 7.19
	ROULETTE FIXE AVEC FREIN BOCKROLLE MIT FESTSTELLER RUOTA FISSA CON FRENO



**RABAIS / RABATT / SCONTO : 20% dès/ab/da 100.-- (CHF) / 25% dès/ab/da 500.-- (CHF)**  
RABAIS DE QUANTITE SUR DEMANDE ! MENGENRABATT AUF ANFRAGE ! SCONTO DI QUANTITA SU RICHIESTA !

**ROULETTES POUR APPAREILS ET HÔPITAUX**

SUPPORT EN ACIER, ZINGUÉ-PROMATISÉ  
PIVOTEMENT SUR DOUBLE RANGÉE DE BILLES  
ROUE À PALIER LISSE, ROUEMENT À ROULEAUX OU À BILLES

**APPARATE- UND SPITAL-ROLLEN**

GEHÄUSE AUS STAHLBLECH, VERZINKT-PROMATISIERT  
SCHWENKLAGER MIT ZWEIFACHEM KUGELKRANZ  
RAD MIT GLEITLAGER, ROLLENLAGER ODER KUGELLAGER

**RUOTE PER ARREDAMENTO ED OSPEDALI**

SUPPORTI IN LAMIERA D'ACCIAIO, ZINCATO-CROMATO  
PIROETTAMENTO A DOPPIA CORONA DI SFERE  
RUOTA A FORO LISCIO, SU CUSCINETTO A RULLI E A SFERE

70 – 100 kg

**CAOUTCHOUC/Thermoplastique**

Roue Caoutchouc Thermoplastique, gris, roue à palier lisse ou avec roulement à billes, non-tachant, silencieux, corps/roue: Nylon renforcé de fibres de verre

RECOMMANDÉ POUR LES CUISINES, LES HOPITAUX ET LES AGENCEMENTS

**GUMMI/Thermoplastisch**

Gummirad Thermoplastisch, grau, Rad mit Gleitlager oder Kugellager, spurfrei, Laufruhe, Radkörper: Nylon und Glasfaser Verbindung

EMPFOHLEN FÜR DIE KÜCHEN, DIE SPITÄLER UND DIE EINRICHTUNGEN

**GOMMA/Termoplastica**

Ruota in Gomma Termoplastica, grigia, ruota a foro liscio o su cuscinetti a sfere, antitraccia, silenziosa, corpo centrale: Nylon rinforzato con fibre di vetro

RACCOMANDATÒ PER LE CUCINE, OSPEDALI E PER ARREDAMENTO

Secteurs / Bereiche / Settori



HOPITAL  
SPITAL  
OSPEDALE



CUISINE  
KÜCHE  
CUCINA

Applications / Anwendung / Applicazioni



CARRELAGE  
FLIESEN  
PIASTRELLE



PARQUET BOIS  
HOLZ-PARKETT  
PARQUET



INDUSTRIE  
INDUSTRIE  
INDUSTRIA

Variantes / Varianten / Varianti



-10° - +65° C  
85 Sh/A



ROUE  
PAGE 7.2  
50 – 200 kg



SERIE 5...8...  
PAGE 5.3  
50 – 200 kg

AVEC PLAQUE / MIT PLATTE / A PIASTRA

AVEC TROU / MIT LOCH / A FORO

ZINGUÉ_SERIE N° 2 'MEDIA' (page 1.8)								ROUE PIVOTANTE LENKROLLE RUOTA GIREVOLE		PIVOTANT/FREIN LENKROLLE/BREMS GIREVOLE/FRENO		ROUE FIXE BOCKROLLE RUOTA FISSA		ROUE PIVOTANTE LENKROLLE RUOTA GIREVOLE		PIVOTANT/FREIN LENKROLLE/BREMS GIREVOLE/FRENO		
mm	mm	Page 1.6	kg	mm	mm	mm	mm	Art. N :	CHF sans TVA	Art. N :	CHF sans TVA	Art. N :	CHF sans TVA	mm	Art. N :	CHF sans TVA	Art. N :	CHF sans TVA
36	2x18		70	60x60	39x39 48x48	6.2	57	2472 P J L 03.60	17.00	2457 P J L 03.60	23.20	---	---	10.2	2472 P J L 03.30	16.00	2457 P J L 03.30	22.10
50	2x19		90	60x60	39x39 48x48	6.2	72	2472 P J L 05.60	15.70	2457 P J L 05.60	20.30	---	---	10.2	2472 P J L 05.30	14.00	2457 P J L 05.30	18.10
50	2x19		90	60x60	39x39 48x48	6.2	72	2472 K 05.60	23.40	2457 K 05.60	26.70	---	---	10.2	2472 K 05.30	22.30	2457 K 05.30	25.20
75	2x22		100	77x67	50x41 61x51	8.3	102	2472 P J L 07.60	24.00	2457 P J L 07.60	31.50	---	---	10.2	2472 P J L 07.30	21.50	2457 P J L 07.30	29.30
75	2x22		100	77x67	50x41 61x51	8.3	102	2472 K 07.60	34.40	2457 K 07.60	39.80	---	---	10.2	2472 K 07.30	32.60	2457 K 07.30	38.30

80 kg

**PNEU-SOFT**

Pneu plein en Polyuréthane-SOFT, gris, roue avec roulement à billes, non-tachant, silencieux, extra-souple, corps/roue: Nylon renforcé de fibres de verre

EXTRA-SOUPLE ET INCREVABLE

**SOFT-REIFEN**

Vollreifen aus Polyurethan-SOFT, grau, Rad mit Kugellager, spurfrei, Laufruhe, extra-weich, Radkörper: Nylon und Glasfaser Verbindung

EXTRA-WEICH UND PANNENSICHER

**PNEUMATICHE-SOFT**

Pneumatica in Poliuretano-SOFT, grigia, ruota su cuscinetti a sfere, antitraccia, silenziosa, grande elasticità, corpo centrale: Nylon rinforzato con fibra di vetro

GRANDE ELASTICITÀ ED A PROVA DI FORATURA

Secteurs / Bereiche / Settori



CUISINE  
KÜCHE  
CUCINA



HOPITAL  
SPITAL  
OSPEDALE

Applications / Anwendung / Applicazioni



CARRELAGE  
FLIESEN  
PIASTRELLE



PAVE  
PFLASTER-STEIN  
PAVIMENTO

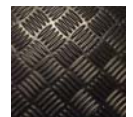

SOL ACIER  
STAHL  
ACCIAIO

Variantes / Varianten / Varianti



-20° - +60° C  
50-60 Sh/A



ROUE  
PAGE 7.6  
120 – 140 kg



SERIE 5...8...  
PAGE 5.9  
120 – 140 kg

AVEC PLAQUE / MIT PLATTE / A PIASTRA

AVEC TROU / MIT LOCH / A FORO

ZINGUÉ_SERIE N° 2 'MEDIA' (page 1.8)								ROUE PIVOTANTE LENKROLLE RUOTA GIREVOLE		PIVOTANT/FREIN LENKROLLE/BREMS GIREVOLE/FRENO		ROUE FIXE BOCKROLLE RUOTA FISSA		ROUE PIVOTANTE LENKROLLE RUOTA GIREVOLE		PIVOTANT/FREIN LENKROLLE/BREMS GIREVOLE/FRENO		
mm	mm	Page 1.6	kg	mm	mm	mm	mm	Art. N :	CHF sans TVA	Art. N :	CHF sans TVA	Art. N :	CHF sans TVA	mm	Art. N :	CHF sans TVA	Art. N :	CHF sans TVA
100	32		80	77x67	50x41 61x51	8.3	124	21 SOF.10	54.80	22 SOF.10	65.50	23 SOF.10	53.00	10.2	20 SOF.10	54.00	27 SOF.10	63.80
100	32		80	77x67	50x41 61x51	8.3	135	2470 SOF 10.60	59.90	2407 SOF 10.60	74.60	2478 SOF 10.60	58.10	10.2	2470 SOF 10.30	59.10	2407 SOF 10.30	72.90
125	32		80	77x67	50x41 61x51	8.3	152	21 SOF.12	66.30	22 SOF.12	78.30	23 SOF.12	60.90	10.2	20 SOF.12	65.20	27 SOF.12	76.30
125	32		80	77x67	50x41 61x51	8.3	161	2470 SOF 12.60	71.50	2407 SOF 12.60	87.40	2478 SOF 12.60	66.10	10.2	2470 SOF 12.30	70.30	2407 SOF 12.30	85.20



**ROULETTES POUR APPAREILS ET HÔPITAUX**

SUPPORT EN ACIER, ZINGUÉ-PROMATISÉ  
PIVOTEMENT SUR DOUBLE RANGÉE DE BILLES  
ROUE À PALIER LISSE, ROULEMENT À ROULEAUX OU À BILLES

**APPARATE- UND SPITAL-ROLLEN**

GEHÄUSE AUS STAHLBLECH, VERZINKT-PROMATISIERT  
SCHWENKLAGER MIT ZWEIFACHEM KUGELKRANZ  
RAD MIT GLEITLAGER, ROLLENLAGER ODER KUGELLAGER

**RUOTE PER ARREDAMENTO ED OSPEDALI**

SUPPORTI IN LAMIERA D'ACCIAIO, ZINCATO-CROMATO  
PIROETTAMENTO A DOPPIA CORONA DI SFERE  
RUOTA A FORO LISCIO, SU CUSCINETTO A RULLI E A SFERE

50 – 120 kg

**POLYURÉTHANE**

Roue Polyuréthane injecté, rouge/brun, roue à palier lisse, avec roulement à rouleaux ou à billes, non-tachant, corps/roue: Nylon 6

**RÉSISTANT AUX HUILES/GRAISSES/ESSENCES...**

**POLYURETHAN**

Rad mit Spritzguss-Polyurethan, rot/braun, Rad mit Gleitlager, Rollenlager oder Kugellager, spurfrei, Radkörper: Nylon 6

**BESTÄNDIGKEIT GEGEN OEL/FETT/BENZIN...**

**POLIURETANO**

Ruota rivestimento in Poliuretano iniettato, rosso/marrone, ruota a foro liscio, su cuscinetti a rulli e a sfere, antitraçcia, corpo centrale: Nylon 6

**RESISTENDO AGLI OLI/GRASSI/PETROLI...**

**Secteurs / Bereiche / Settori**



HUILE/ESSENCE  
OEL/BENZIN  
OLI/PETROLI



USINE  
FABRIK  
INDUSTRIA

**Applications / Anwendung / Applicazioni**



GOUDRON  
ASPHALT  
ASFALTO



INDUSTRIE  
INDUSTRIE  
INDUSTRIA

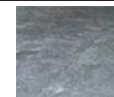

BETON  
BETON  
CEMENTO

**Variantes / Varianten / Varianti**



-25° - +80° C  
94 Sh/A



**ROUE**  
PAGE 7.9  
80 – 290 kg



**SERIE 55..**  
PAGE 4.5  
210 – 290 kg



**SERIE 5..-7..**  
PAGE 5.15  
120 – 280 kg

**AVEC PLAQUE / MIT PLATTE / A PIASTRA**

**AVEC TROU / MIT LOCH / A FORO**

								ROUE PIVOTANTE LENKROLLE RUOTA GIREVOLE		PIVOTANT/FREIN LENKROLLE/BREMS GIREVOLE/FRENO		ROUE FIXE BOCKROLLE RUOTA FISSA				ROUE PIVOTANTE LENKROLLE RUOTA GIREVOLE		PIVOTANT/FREIN LENKROLLE/BREMS GIREVOLE/FRENO		
mm	mm	Page 1.6	kg	mm	mm	mm	mm	Art. N :	Prix Preis Prezzo CHF sans TVA	Art. N :	Prix Preis Prezzo CHF sans TVA	Art. N :	Prix Preis Prezzo CHF sans TVA	mm	Art. N :	Prix Preis Prezzo CHF sans TVA	Art. N :	Prix Preis Prezzo CHF sans TVA		
<b>ZINGUÉ_SERIE N° 3 'LEGER' (page 1.8)</b>																				
50	19		50	B) 60x60	B) 39x39	48x48	6.2	71	25	3171.05	11.60	3271.05	14.80	3371.05	9.20	10.2	3071.05	10.40	3771.05	14.20
A) 50	19		60	B) 60x60	B) 39x39	48x48	6.2	71	25	3173.05	17.10	3273.05	19.60	3373.05	15.10	10.2	3073.05	15.70	3773.05	18.90
A) 75	25		70	C) 60x60	39x39	48x48	6.2	97	30	3173.07	21.70	3273.07	25.20	3373.07	19.00	10.2	3073.07	20.00	3773.07	24.00
<b>ZINGUÉ_SERIE N° 2 'MEDIA' (page 1.8)</b>																				
100	30		120	77x67	50x41	61x51	8.3	135	38	2470 DR 10.60	31.80	2407 DR 10.60	46.60	2478 DR 10.60	30.10	D) 10.2	2470 DR 10.30	30.90	2407 DR 10.30	44.90

- A) POLYURETHANE GRIS/NOIR / POLYURETHAN GRAU/SCHWARZ / POLIURETANO GRIGIA/NERA
- B) ROULETTE FIXE, PLAQUE / BOCKROLLE, PLATTE / RUOTA FISSA, PIASTRA: 55x55mm – 39x39 / 45x45mm
- C) ROULETTE FIXE, PLAQUE / BOCKROLLE, PLATTE / RUOTA FISSA, PIASTRA: 67.5x60mm – 39x39 / 48x48mm
- D) EGALEMENT AVEC TROU 12,3mm / AUCH MIT LOCH 12,3mm / ANCHE A FORO 12,3mm

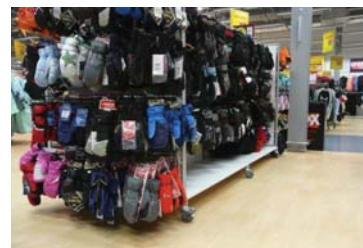

**RABAIS / RABATT / SCONTO : 20% dès/ab/da 100.-- (CHF) / 25% dès/ab/da 500.-- (CHF)**  
RABAIS DE QUANTITE SUR DEMANDE ! MINGENRABATT AUF ANFRAGE ! SCONTO DI QUANTITA SU RICHIESTA !

**ROULETTES POUR APPAREILS ET HÔPITAUX**

SUPPORT EN ACIER, ZINGUÉ-PROMATISÉ  
PIVOTEMENT SUR DOUBLE RANGÉE DE BILLES  
ROUE À PALIER LISSE, ROULEMENT À ROULEAUX OU À BILLES

**APPARATE- UND SPITAL-ROLLEN**

GEHÄUSE AUS STAHLBLECH, VERZINKT-PROMATISIERT  
SCHWENKLAGER MIT ZWEIFACHEM KUGELKRANZ  
RAD MIT GLEITLAGER, ROLLENLAGER ODER KUGELLAGER

**RUOTE PER ARREDAMENTO ED OSPEDALI**

SUPPORTI IN LAMIERA D'ACCIAIO, ZINCATO-CROMATO  
PIROETTAMENTO A DOPPIA CORONA DI SFERE  
RUOTA A FORO LISCIO, SU CUSCINETTO A RULLI E A SFERE

60 – 120 kg

**POLYURÉTHANE**

Roue Polyuréthane injecté, gris, roue avec roulement à billes, non-tachant, silencieux  
corps/roue: Nylon 6 renforcé de fibres de verre, résistant aux huiles/grasses/essences...

RECOMMANDÉ POUR LES INDUSTRIES ET LES AGENCEMENTS

**POLYURETHAN**

Rad mit Spritzguss-Polyurethan, grau, Rad mit Kugellager, spurfrei, Laufruhe  
beständigkeit gegen Öl/Fett/Benzin..., Radkörper: Nylon und Glasfaser Verbindung

EMPFOHLEN FÜR INDUSTRIE UND DIE EINRICHTUNGEN

**POLIURETANO**

Ruota rivestimento in Poliuretano iniettato, grigia, ruota su cuscinetti a sfere, antiraccia,  
silencia, resistendo agli oli/grassi/petroli..., corpo centrale: Nylon rinforzato con fibra di vetro

RACCOMANDATÒ PER INDUSTRIA E PER ARREDAMENTO

Secteurs / Bereiche / Settori



HUILE/ESSENCE  
ÖL/BENZIN  
OLIV/PETROLI



USINE  
FABRIK  
INDUSTRIA

Applications / Anwendung / Applicazioni



BETON  
BETON  
CEMENTO



INDUSTRIE  
INDUSTRIE  
INDUSTRIA



TAPIS  
TEPPICH  
MOQUETTE

Variantes / Varianten / Varianti



-25° - +80° C  
85 Sh/A



ROUE  
PAGE 7.7  
60 – 490 kg



SERIE H..  
PAGE 3.12  
100 – 120 kg



SERIE 5..-8..  
PAGE 5.11-12  
120 – 480 kg



SERIE 9../TH..  
PAGE 6.3  
390 – 950 kg

AVEC PLAQUE / MIT PLATTE / A PIASTRA

AVEC TROU / MIT LOCH / A FORO

								ROUE PIVOTANTE LENKROLLE RUOTA GIREVOLE		PIVOTANT/FREIN LENKROLLE/BREMS GIREVOLE/FRENO		ROUE FIXE BOCKROLLE RUOTA FISSA				ROUE PIVOTANTE LENKROLLE RUOTA GIREVOLE		PIVOTANT/FREIN LENKROLLE/BREMS GIREVOLE/FRENO	
mm	mm	Page 1.6	kg	mm	mm	mm	mm	Art. N :	CHF sans TVA	Art. N :	CHF sans TVA	Art. N :	CHF sans TVA	mm	Art. N :	CHF sans TVA	Art. N :	CHF sans TVA	
<b>ZINGUÉ_SERIE N° 3 'LEGER' (page 1.8)</b>																			
60	25		60	A) 60x60	39x39 48x48	6.2	82	25	3173.06	18.90	3273.06	21.60	3373.06	16.50	10.2	3073.06	17.70	3773.06	20.70
80	25		70	A) 60x60	39x39 48x48	6.2	100	30	3173.08	25.20	3273.08	29.20	3373.08	22.10	10.2	3073.08	24.20	3773.08	27.80
100	25		80	A) 60x60	39x39 48x48	6.2	121	32	3173.10	27.80	3273.10	32.30	3373.10	25.00	10.2	3073.10	26.40	3773.10	31.00
125	25		90	A) 60x60	39x39 48x48	6.2	148	35	3173.12	33.60	3273.12	37.60	---		10.2	3073.12	32.50	3773.12	36.40
<b>ZINGUÉ_SERIE N° 2 'MEDIA' (page 1.8)</b>																			
80	32		90	77x67	50x41 61x51	8.3	103	26	2173.08	28.10	2273.08	35.20	2373.08	26.10	10.2	2073.08	26.80	2773.08	33.20
100	32		100	77x67	50x41 61x51	8.3	124	28	2173.10	33.80	2273.10	42.20	2373.10	31.60	10.2	2073.10	32.80	2773.10	40.90
100	32		110	77x67	50x41 61x51	8.3	135	38	2470 DK 10.60	36.20	2407 DK 10.60	51.90	2478 DK 10.60	34.40	10.2	2470 DK 10.30	34.80	2407 DK 10.30	50.00
125	32		110	77x67	50x41 61x51	8.3	152	37	2173.12	38.30	2273.12	46.40	2373.12	35.10	10.2	2073.12	36.10	2773.12	44.50
125	32		120	77x67	50x41 61x51	8.3	161	40	2470 DK 12.60	43.50	2407 DK 12.60	59.90	2478 DK 12.60	37.90	10.2	2470 DK 12.30	37.70	2407 DK 12.30	53.50
<b>INOX_SERIE N° 3 'LEGER' (page 1.8)</b>																			
<b>INOX / ROSTFREI / INOX</b>																			
60	25		70	65x65	40x40 50x50	6.5	B) 86	26 / 37	X-3173.06	39.40	X-3273.06	48.30	sur demande auf Anfrage	C) 12.3	X-3073.06	32.60	X-3773.06	45.40	
80	25		70	65x65	40x40 50x50	6.5	B) 108	38 / 37	X-3173.08	44.10	X-3273.08	53.80	sur demande auf Anfrage	C) 12.3	X-3073.08	37.70	X-3773.08	46.90	
100	25		80	65x65	40x40 50x50	6.5	B) 130	38 / 35	X-3173.10	48.00	X-3273.10	57.60	sur demande auf Anfrage	C) 12.3	X-3073.10	41.40	X-3773.10	50.70	
125	25		90	65x65	40x40 50x50	6.5	B) 158	38 / 35	X-3173.12	54.70	X-3273.12	64.10	sur demande auf Anfrage	C) 12.3	X-3073.12	48.00	X-3773.12	57.20	

A) ROULETTE FIXE, PLAQUE / BOCKROLLE, PLATTE / RUOTA FISSA, PIASTRA: 67.5x60mm – 39x39 / 48x48mm  
B) ROULETTE AVEC PLAQUE, HAUTEUR +3mm / ROLLEN MIT PLATTE, BAUHÖHE +3mm / RUOTA A PIASTRA, ALTEZZA UTILE +3mm  
C) EGAGEMENT AVEC TROU 10.2mm / AUCH MIT LOCH 10.2mm / ANCHE A FORO 10.3mm

FIXATION, PAGE 7.19  
BEFESTIGUNG, SEITE 7.19  
FISSAZIONE, PAGINA 7.19

FIXATION, PAGE 7.19  
BEFESTIGUNG, SEITE 7.19  
FISSAZIONE, PAGINA 7.19

ROULETTE FIXE AVEC FREIN  
BOCKROLLE MIT FESTSTELLER  
RUOTA FISSA CON FRENO





**ROULETTES POUR APPAREILS ET HÔPITAUX**

SUPPORT EN ACIER, ZINGUÉ-PROMATISÉ  
PIVOTEMENT SUR DOUBLE RANGÉE DE BILLES  
ROUE À PALIER LISSE, ROULEMENT À ROULEAUX OU À BILLES

**APPARATE- UND SPITAL-ROLLEN**

GEHÄUSE AUS STAHLBLECH, VERZINKT-PROMATISIERT  
SCHWENKLAGER MIT ZWEIFACHEM KUGELKRANZ  
RAD MIT GLEITLAGER, ROLLENLAGER ODER KUGELLAGER

**RUOTE PER ARREDAMENTO ED OSPEDALI**

SUPPORTI IN LAMIERA D'ACCIAIO, ZINCATO-CROMATO  
PIROETTAMENTO A DOPPIA CORONA DI SFERE  
RUOTA A FORO LISCIO, SU CUSCINETTO A RULLI E A SFERE

50 – 90 kg

**POLYURÉTHANE-ANTISTATIQUE**

Roue Polyuréthane injecté, gris, roue avec roulement à billes, non-tachant, silencieux  
corps/roue: Nylon 6 renforcé de fibres de verre, résistant aux huiles/graisse/essences...

AVEC ROUES ANTISTATIQUES, RECOMMANDÉ POUR LES HÔPITAUX ET L'INDUSTRIE

**POLYURETHAN-ANTISTATISCH**

Rad mit Spritzguss-Polyurethan, grau, Rad mit Kugellager, spurfrei, Laufruhe  
beständigkeit gegen Öl/Fett/Benzin..., Radkörper: Nylon und Glasfaser Verbindung

MIT ANTISTATISCH-RÄDERN, EMPFOHLEN FÜR SPITÄLER UND INDUSTRIE

**POLIURETANO-ANTISTATICO**

Ruota rivestimento in Poliuretano iniettato, grigia, ruota su cuscinetti a sfere, antitraccia,  
silenziosa, resistendo agli oli/grassi/petroli..., corpo centrale: Nylon rinforzato con fibra di vetro

CON ANTISTATICO-RUOTE, RACCOMANDATÒ PER OSPEDALI ED INDUSTRIA

**Secteurs / Bereiche / Settori**

HUILE/ESSENCE  
ÖL/BENZIN  
OLI/PETROLI



HOPITAL  
SPITAL  
OSPEDALE

**Applications / Anwendung / Applicazioni**

ANTISTATIQUE  
ANTISTATISCH  
ANTISTATICO



INDUSTRIE  
INDUSTRIE  
INDUSTRIA

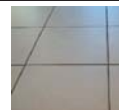

CARRELAGE  
FLIESEN  
PIASTRELLE

**Variantes / Varianten / Varianti**

-25° - +80° C  
87 Sh/A



ROUE  
PAGE 7.8  
60 – 490 kg



SERIE H..  
PAGE 3.12  
100 – 120 kg



SERIE 5.-8..  
PAGE 5.13-14  
120 – 480 kg



SERIE 9./TH..  
PAGE 6.4  
390 – 950 kg

**AVEC PLAQUE / MIT PLATTE / A PIASTRA****AVEC TROU / MIT LOCH / A FORO**

										ROUE PIVOTANTE LENKROLLE RUOTA GIREVOLE		PIVOTANT/FREIN LENKROLLE/BREMS GIREVOLE/FRENO		ROUE FIXE BOCKROLLE RUOTA FISSA												ROUE PIVOTANTE LENKROLLE RUOTA GIREVOLE		PIVOTANT/FREIN LENKROLLE/BREMS GIREVOLE/FRENO	
										Prix Preis Prezzo		Prix Preis Prezzo		Prix Preis Prezzo												Prix Preis Prezzo		Prix Preis Prezzo	
										Art. N :	CHF sans TVA	Art. N :	CHF sans TVA	Art. N :	CHF sans TVA											Art. N :	CHF sans TVA	Art. N :	CHF sans TVA
<b>ZINGUÉ SERIE N° 3 'LEGER' (page 1.8)</b>																													
A)	50	19		50	B)	39x39 48x48	6.2	71	25	3173.05-A	20.70	3273.05-A	23.90	3373.05-A	18.60	10.2	3073.05-A	19.80	3773.05-A	22.60									
	60	25		60	C)	39x39 48x48	6.2	82	25	3173.06-A	20.50	3273.06-A	23.50	3373.06-A	18.30	10.2	3073.06-A	19.60	3773.06-A	22.30									
A)	75	25		60	C)	39x39 48x48	6.2	97	30	3173.07-A	28.20	3273.07-A	31.60	3373.07-A	25.40	10.2	3073.07-A	27.30	3773.07-A	30.40									
	80	25		70	C)	39x39 48x48	6.2	100	30	3173.08-A	27.20	3273.08-A	30.90	3373.08-A	24.20	10.2	3073.08-A	26.10	3773.08-A	29.50									
	100	25		80	C)	39x39 48x48	6.2	121	32	3173.10-A	33.50	3273.10-A	37.20	3373.10-A	30.90	10.2	3073.10-A	32.30	3773.10-A	36.20									
	125	25		90	C)	39x39 48x48	6.2	148	35	3173.12-A	44.90	3273.12-A	48.90	---		10.2	3073.12-A	43.90	3773.12-A	47.70									
<b>ZINGUÉ SERIE N° 2 'MEDIA' (page 1.8)</b>																													
	80	32		90	77x67	50x41 61x51	8.3	103	26	2173.08-A	34.50	2273.08-A	41.80	2373.08-A	32.30	10.2	2073.08-A	32.80	2773.08-A	40.10									
	100	32		100	77x67	50x41 61x51	8.3	124	28	2173.10-A	41.60	2273.10-A	50.50	2373.10-A	39.00	10.2	2073.10-A	40.10	2773.10-A	48.70									
	100	32		110	77x67	50x41 61x51	8.3	135	38	2470 DK 10.60-A	44.10	2407 DK 10.60-A	59.50	2478 DK 10.60-A	42.30	10.2	2470 DK 10.30-A	41.00	2407 DK 10.30-A	57.80									
	125	32		110	77x67	50x41 61x51	8.3	152	37	2173.12-A	53.00	2273.12-A	62.00	2373.12-A	50.30	10.2	2073.12-A	51.30	2773.12-A	60.70									
	125	32		120	77x67	50x41 61x51	8.3	161	40	2470 DK 12.60-A	58.10	2407 DK 12.60-A	74.80	2478 DK 12.60-A	52.90	10.2	2470 DK 12.30-A	50.10	2407 DK 12.30-A	68.40									
<b>INOX SERIE N° 3 'LEGER' (page 1.8)</b>										<b>INOX / ROSTFREI / INOX</b>										<b>INOX / ROSTFREI / INOX</b>									
	60	25		70	65x65	40x40 50x50	6.5	D)	86	26 / 37	X-3173.06-A	42.30	X-3273.06-A	51.70	sur demande auf Anfrage	E)	12.3	X-3073.06-A	35.80	X-3773.06-A	44.80								
	80	25		70	65x65	40x40 50x50	6.5	D)	108	38 / 37	X-3173.08-A	49.70	X-3273.08-A	59.40	sur demande auf Anfrage	E)	12.3	X-3073.08-A	43.00	X-3773.08-A	52.40								
	100	25		80	65x65	40x40 50x50	6.5	D)	130	38 / 35	X-3173.10-A	57.60	X-3273.10-A	67.00	sur demande auf Anfrage	E)	12.3	X-3073.10-A	50.60	X-3773.10-A	60.00								
	125	25		90	65x65	40x40 50x50	6.5	D)	158	38 / 35	X-3173.12-A	69.40	X-3273.12-A	79.10	sur demande auf Anfrage	E)	12.3	X-3073.12-A	62.70	X-3773.12-A	72.40								

A) ROUE EN CAOUTCHOUC / VOLLGUMMIRAD / RUOTA IN GOMMA

B) ROULETTE FIXE, PLAQUE / BOCKROLLE, PLATTE / RUOTA FISSA, PIASTRA: 55x55mm – 39x39 / 45x45mm

C) ROULETTE FIXE, PLAQUE / BOCKROLLE, PLATTE / RUOTA FISSA, PIASTRA: 67.5x60mm – 39x39 / 48x48mm

D) ROULETTE AVEC PLAQUE, HAUTEUR +3mm / ROLLEN MIT PLATTE, BAUHÖHE +3mm / RUOTA A PIASTRA, ALTEZZA UTILE +3mm

E) EGALLEMENT AVEC TROU 10.2mm / AUCH MIT LOCH 10.2mm / ANCHE A FORO 10.2mm

**RABAIS SPÉCIAL 'SET-STATIF' PAGE 2.9****SPEZIAL-RABATT 'SET-STATIF' SEITE 2.9****SCONTO SPECIALE 'SET-STATIF' PAGINA 2.9**

FIXATION, PAGE 7.19  
BEFESTIGUNG, SEITE 7.19  
FISSAZIONE, PAGINA 7.19



FIXATION, PAGE 7.19  
BEFESTIGUNG, SEITE 7.19  
FISSAZIONE, PAGINA 7.19

**RABAIS / RABATT / SCONTO : 20% dès/ab/da 100.-- (CHF) / 25% dès/ab/da 500.-- (CHF)**  
RABAIS DE QUANTITE SUR DEMANDE ! MENGENRABATT AUF ANFRAGE ! SCONTO DI QUANTITA SU RICHIESTA !



**ROULETTES POUR APPAREILS ET HÔPITAUX**

SUPPORT EN ACIER, ZINGUÉ-PROMATISÉ  
PIVOTEMENT SUR DOUBLE RANGÉE DE BILLES  
ROUE À PALIER LISSE, ROUEMENT À ROULEAUX OU À BILLES

**APPARATE- UND SPITAL-ROLLEN**

GEHÄUSE AUS STAHLBLECH, VERZINKT-PROMATISIERT  
SCHWENKLAGER MIT ZWEIFACHEM KUGELKRANZ  
RAD MIT GLEITLAGER, ROLLENLAGER ODER KUGELLAGER

**RUOTE PER ARREDAMENTO ED OSPEDALI**

SUPPORTI IN LAMIERA D'ACCIAIO, ZINCATO-CROMATO  
PIROETTAMENTO A DOPPIA CORONA DI SFERE  
RUOTA A FORO LISCIO, SU CUSCINETTO A RULLI E A SFERE

80 – 120 kg

**POLYURÉTHANE**

Roue Polyuréthane injecté, gris, roue avec roulement à billes, non-tachant, silencieux  
corps/roue: Nylon 6 renforcé de fibres de verre, résistant aux huiles/grasses/essences...

**RECOMMANDÉ POUR LES INDUSTRIES ET LES AGENCEMENTS**

**POLYURETHAN**

Rad mit Spritzguss-Polyurethan, grau, Rad mit Kugellager, spurfrei, Laufruhe  
beständigkeit gegen Öl/Fett/Benzin..., Radkörper: Nylon und Glasfaser Verbindung

**EMPFOHLEN FÜR INDUSTRIE UND DIE EINRICHTUNGEN**

**POLIURETANO**

Ruota rivestimento in Poliuretano iniettato, grigia, ruota su cuscinetti a sfere, antiraccia,  
silencia, resistendo agli oli/grassi/petroli..., corpo centrale: Nylon rinforzato con fibra di vetro

**RACCOMANDATÒ PER INDUSTRIA E PER ARREDAMENTO**

**Secteurs / Bereiche / Settori**



HUILE/ESSENCE  
OEL/BENZIN  
OLIV/PETROLI



USINE  
FABRIK  
INDUSTRIA

**Applications / Anwendung / Applicazioni**



BETON  
BETON  
CEMENTO



INDUSTRIE  
INDUSTRIE  
INDUSTRIA



TAPIS  
TEPPICH  
MOQUETTE

**Variantes / Varianten / Varianti**



-25° - +80° C  
85 Sh/A



**ROUE**  
PAGE 7.7  
60 – 490 kg



**ROUE**  
PAGE 7.8  
60 – 490 kg



**SERIE TH..**  
PAGE 6.3  
730 – 950 kg

**AVEC PLAQUE / MIT PLATTE / A PIASTRA**

**AVEC TROU / MIT LOCH / A FORO**

								ROUE PIVOTANTE LENKROLLE RUOTA GIREVOLE		PIVOTANT/FREIN LENKROLLE/BREMS GIREVOLE/FRENO		ROUE FIXE BOCKROLLE RUOTA FISSA										ROUE PIVOTANTE LENKROLLE RUOTA GIREVOLE		PIVOTANT/FREIN LENKROLLE/BREMS GIREVOLE/FRENO	
mm	mm	Page 1.6	kg	mm	mm	mm	mm	Art. N :	CHF sans TVA	Art. N :	CHF sans TVA	Art. N :	CHF sans TVA	mm	Art. N :	CHF sans TVA	Art. N :	CHF sans TVA	Art. N :	CHF sans TVA	Art. N :	CHF sans TVA			
<b>ZINGUÉ_SERIE N° 2 'MEDIA' (page 1.8)</b>																									
50	2x19	100	60x60	39x39 48x48	6.2	72	24	2472 DL 05.60	19.80	2457 DL 05.60	24.30	---	---	10.2	2472 DL 05.30	18.10	2457 DL 05.30	22.30							
50	2x19	110	60x60	39x39 48x48	6.2	72	24	2472 DK 05.60	31.60	2457 DK 05.60	35.20	---	---	10.2	2472 DK 05.30	30.20	2457 DK 05.30	33.50							
75	2x22	120	77x67	50x41 61x51	8.3	102	34	2472 DK 07.60	39.50	2457 DK 07.60	44.90	---	---	10.2	2472 DK 07.30	37.70	2457 DK 07.30	43.50							
<b>ZINGUÉ_SERIE N° 2 'MEDIA' (page 1.8)</b>																									
								<b>ANTISTATIC</b>		<b>ANTISTATIC</b>					<b>ANTISTATIC</b>		<b>ANTISTATIC</b>								
50	2x19	110	60x60	39x39 48x48	6.2	72	24	2472 DK 05.60-A	36.20	2457 DK 05.60-A	39.60	---	---	10.2	2472 DK 05.30-A	35.10	2457 DK 05.30-A	38.10							
75	2x22	120	77x67	50x41 61x51	8.3	102	34	2472 DK 07.60-A	53.50	2457 DK 07.60-A	59.10	---	---	10.2	2472 DK 07.30-A	51.60	2457 DK 07.30-A	57.60							

A) ROUE EN POLYURETHANE, ROUGE/BRUN / POLYURETHAN-RAD, ROT/BRAUN / RUOTA IN POLIURETANO, ROSSO/MARRONE

60 – 90 kg

**POLYAMIDE / NYLON**

Roue Polyamide, noir, roue à palier lisse ou avec roulement à rouleaux  
non-tachant, corps/roue: Polyamide

**RÉSISTANT AUX HUILES/GRAISSES/ESSENCES...**

**POLYAMID / NYLON**

Polyamid-Rad, schwarz, Rad mit Gleitlager oder Rollenlager  
spurfrei, Radkörper: Polyamid

**BESTÄNDIGKEIT GEGEN OEL/FETT/BENZIN...**

**POLIAMMIDE / NYLON**

Ruota in Poliammide, nero, ruota a foro liscio e su cuscinetto a rulli  
antiraccia, corpo centrale: Poliammide

**RESISTENDO AGLI OLI/GRASSI/PETROLI...**

**Secteurs / Bereiche / Settori**



HUILE/ESSENCE  
OEL/BENZIN  
OLIV/PETROLI



USINE  
FABRIK  
INDUSTRIA

**Applications / Anwendung / Applicazioni**



INDUSTRIE  
INDUSTRIE  
INDUSTRIA



BETON  
BETON  
CEMENTO



TAPIS  
TEPPICH  
MOQUETTE

**Variantes / Varianten / Varianti**



-30° - +80° C  
NYLON



**ROUE**  
PAGE 7.13  
60 – 500 kg



**SERIE TH..**  
PAGE 6.9  
1400 – 2200 kg

**AVEC PLAQUE / MIT PLATTE / A PIASTRA**

**AVEC TROU / MIT LOCH / A FORO**

								ROUE PIVOTANTE LENKROLLE RUOTA GIREVOLE		PIVOTANT/FREIN LENKROLLE/BREMS GIREVOLE/FRENO		ROUE FIXE BOCKROLLE RUOTA FISSA										ROUE PIVOTANTE LENKROLLE RUOTA GIREVOLE		PIVOTANT/FREIN LENKROLLE/BREMS GIREVOLE/FRENO	
mm	mm	Page 1.6	kg	mm	mm	mm	mm	Art. N :	CHF sans TVA	Art. N :	CHF sans TVA	Art. N :	CHF sans TVA	mm	Art. N :	CHF sans TVA	Art. N :	CHF sans TVA	Art. N :	CHF sans TVA	Art. N :	CHF sans TVA			
<b>ZINGUÉ_SERIE N° 2 'MEDIA' (page 1.8)</b>																									
36	2x18	80	60x60	39x39 48x48	6.2	57	24	2472 N 03.60	17.00	2457 N 03.60	23.20	---	---	10.2	2472 N 03.30	16.00	2457 N 03.30	22.10							
50	2x19	100	60x60	39x39 48x48	6.2	72	24	2472 N 05.60	14.00	2457 N 05.60	18.60	---	---	10.2	2472 N 05.30	12.90	2457 N 05.30	16.50							
75	2x22	120	77x67	50x41 61x51	8.3	102	34	2472 N 07.60	22.30	2457 N 07.60	29.80	---	---	10.2	2472 N 07.30	19.80	2457 N 07.30	27.70							

**ROULETTES POUR APPAREILS ET HÔPITAUX**

SUPPORT EN ACIER, ZINGUÉ-PROMATISÉ  
PIVOTEMENT SUR DOUBLE RANGÉE DE BILLES  
ROUE À PALIER LISSE, ROULEMENT À ROULEAUX OU À BILLES

**APPARATE- UND SPITAL-ROLLEN**

GEHÄUSE AUS STAHLBLECH, VERZINKT-PROMATISIERT  
SCHWENKLAGER MIT ZWEIFACHEM KUGELKRANZ  
RAD MIT GLEITLAGER, ROLLENLAGER ODER KUGELLAGER

**RUOTE PER ARREDAMENTO ED OSPEDALI**

SUPPORTI IN LAMIERA D'ACCIAIO, ZINCATO-CROMATO  
PIROETTAMENTO A DOPPIA CORONA DI SFERE  
RUOTA A FORO LISCIO, SU CUSCINETTO A RULLI E A SFERE

**50 – 120 kg****POLYAMIDE / NYLON**

Roue Polyamide, noir ou blanc, roue à palier lisse ou avec roulement à rouleaux non-tachant, corps/roue: Polyamide

**RÉSISTANT AUX HUILES/GRAISSES/ESSENCES...**

**POLYAMID / NYLON**

Polyamid-Rad, schwarz oder weiss, Rad mit Gleitlager oder Rollenlager spurfrei, Radkörper: Polyamid

**BESTÄNDIGKEIT GEGEN OEL/FETT/BENZIN...**

**POLIAMMIDE / NYLON**

Ruota in Poliammide, nero e bianco, ruota a foro liscio e su cuscinetto a rulli antitraccia, corpo centrale: Poliammide

**RESISTENDO AGLI OLI/GRASSI/PETROLI...**

**Secteurs / Bereiche / Settori**

HUILE/ESSENCE  
OEL/BENZIN  
OLI/PETROLI



USINE  
FABRIK  
INDUSTRIA

**Applications / Anwendung / Applicazioni**

INDUSTRIE  
INDUSTRIE  
INDUSTRIA



BETON  
BETON  
CEMENTO



TAPIS  
TEPPICH  
MOQUETTE

**Variantes / Varianten / Varianti**

-30° - +80° C  
NYLON



**ROUE**  
PAGE 7.13-14  
55 – 2500 kg



**SERIE TL..**  
PAGE 4.1  
80 – 320 kg



**SERIE 5..-8..**  
PAGE 5.17-19  
130 – 480 kg



**SERIE 9../TH..**  
PAGE 6.9-10  
700 – 2700 kg

**AVEC PLAQUE / MIT PLATTE / A PIASTRA****AVEC TROU / MIT LOCH / A FORO**

										ROUE PIVOTANTE LENKROLLE RUOTA GIREVOLE		PIVOTANT/FREIN LENKROLLE/BREMS GIREVOLE/FRENO		ROUE FIXE BOCKROLLE RUOTA FISSA				ROUE PIVOTANTE LENKROLLE RUOTA GIREVOLE		PIVOTANT/FREIN LENKROLLE/BREMS GIREVOLE/FRENO	
mm	mm	Page	kg	mm	mm	mm	mm	mm	mm	Art. N :	CHF sans TVA	Art. N :	CHF sans TVA	Art. N :	CHF sans TVA	mm	Art. N :	CHF sans TVA	Art. N :	CHF sans TVA	
<b>ZINGUÉ_SERIE N° 3 'LEGER' (page 1.8)</b>																					
50	19			50 <sup>B)</sup>	60x60	39x39 48x48	6.2	71	25	3161.05	10.10	3261.05	13.60	3361.05	7.40	10.2	3061.05	8.80	3761.05	12.30	
60	25			55 <sup>C)</sup>	60x60	39x39 48x48	6.2	82	25	3161.06	11.20	3261.06	14.70	3361.06	8.10	10.2	3061.06	9.60	3761.06	13.60	
75	25			60 <sup>C)</sup>	60x60	39x39 48x48	6.2	97	30	3161.07	12.90	3261.07	17.40	3361.07	9.20	10.2	3061.07	11.60	3761.07	15.70	
100	25			80 <sup>C)</sup>	60x60	39x39 48x48	6.2	121	32	3161.10	14.90	3261.10	19.50	3361.10	11.60	10.2	3061.10	13.20	3761.10	18.10	
<b>ZINGUÉ_SERIE N° 2 'MEDIA' (page 1.8)</b>																					
75	28			90	77x67	50x41 61x51	8.3	101	26	2161.07	18.60	2261.07	24.00	2361.07	15.30	10.2	2061.07	16.50	2761.07	22.00	
80	28			90	77x67	50x41 61x51	8.3	103	26	2161.08	19.00	2261.08	24.30	2361.08	16.10	10.2	2061.08	17.00	2761.08	22.30	
100	28			100	77x67	50x41 61x51	8.3	124	28	2161.10	21.20	2261.10	27.70	2361.10	18.10	10.2	2061.10	19.80	2761.10	26.00	
100	30			120	77x67	50x41 61x51	8.3	135	38	2470 NR 10.60	27.60	2407 NR 10.60	44.80	2478 NR 10.60	25.90	10.2	2470 NR 10.30	24.10	2407 NR 10.30	42.90	
125	28			110	77x67	50x41 61x51	8.3	152	37	2161.12	25.20	2261.12	30.90	2361.12	22.00	10.2	2061.12	23.20	2761.12	29.30	
<b>INOX_SERIE N° 3 'LEGER' (page 1.8)</b>																					
<b>INOX / ROSTFREI / INOX</b>																					
60	25			60	65x65	40x40 50x50	6.5	<sup>D)</sup> 86	26 / 37	X-3161.06	29.30	X-3261.06	38.30	sur demande auf Anfrage		<sup>E)</sup> 12.3	X-3061.06	23.00	X-3761.06	31.70	
80	25			70	65x65	40x40 50x50	6.5	<sup>D)</sup> 108	38 / 37	X-3161.08	31.70	X-3261.08	41.00	sur demande auf Anfrage		<sup>E)</sup> 12.3	X-3061.08	25.50	X-3761.08	34.50	
100	25			80	65x65	40x40 50x50	6.5	<sup>D)</sup> 130	38 / 35	X-3161.10	34.30	X-3261.10	43.20	sur demande auf Anfrage		<sup>E)</sup> 12.3	X-3061.10	27.60	X-3761.10	36.80	

A) ROUE EN POLYAMIDE, BLANC / POLYAMID-RAD, WEISS / RUOTA IN NYLON, BIANCO

B) ROULETTE FIXE, PLAQUE / BOCKROLLE, PLATTE / RUOTA FISSA, PIASTRA: 55x55mm – 39x39 / 45x45mm

C) ROULETTE FIXE, PLAQUE / BOCKROLLE, PLATTE / RUOTA FISSA, PIASTRA: 67.5x60mm – 39x39 / 48x48mm

D) ROULETTE AVEC PLAQUE, HAUTEUR +3mm / ROLLEN MIT PLATTE, BAUHÖHE +3mm / RUOTA A PIASTRA, ALTEZZA UTILE +3mm

E) EGAGEMENT AVEC TROU 10.2mm / AUCH MIT LOCH 10.2mm / ANCHE A FORO 10.2mm



FIXATION, PAGE 7.19  
BEFESTIGUNG, SEITE 7.19  
FISSAZIONE, PAGINA 7.19



FIXATION, PAGE 7.19  
BEFESTIGUNG, SEITE 7.19  
FISSAZIONE, PAGINA 7.19

**RABAIS / RABATT / SCONTO :**

**20%** dès/ab/da 100.-- (CHF)

**25%** dès/ab/da 500.-- (CHF)

RABAIS DE QUANTITE SUR DEMANDE !

MENGENRABATT AUF ANFRAGE !

SCONTO DI QUANTITA SU RICHIESTA !

**ROULETTES POUR APPAREILS ET HÔPITAUX**

SUPPORT EN ACIER, ZINGUÉ-PROMATISIÉ  
PIVOTEMENT SUR DOUBLE RANGÉE DE BILLES  
ROUE À PALIER LISSE, ROULEMENT À ROULEAUX OU À BILLES

**APPARATE- UND SPITAL-ROLLEN**

GEHÄUSE AUS STAHLBLECH, VERZINKT-PROMATISIERT  
SCHWENKLAGER MIT ZWEIFACHEM KUGELKRANZ  
RAD MIT GLEITLAGER, ROLLENLAGER ODER KUGELLAGER

**RUOTE PER ARREDAMENTO ED OSPEDALI**

SUPPORTI IN LAMIERA D'ACCIAIO, ZINCATO-CROMATO  
PIROETTAMENTO A DOPPIA CORONA DI SFERE  
RUOTA A FORO LISCIO, SU CUSCINETTO A RULLI E A SFERE

35 – 80 kg

**CAOUTCHOUC**

Roüe en bois de hêtre, avec double anneau en caoutchouc noir, palier de roue lisse, design, silencieux, corps/roue: Hêtre

RECOMMANDÉ POUR LES CUISINES, BUREAUX ET LES AGENCEMENTS

**GUMMI**

Rad aus Buchenholz mit doppelten schwarzen Gummiringen, Rad mit Gleitlager spurfrei, Laufruhe, Radkörper: Nylon und Glasfaser Verbindung

EMPFOHLEN FÜR DIE KÜCHEN, DIE SPITÄLER UND DIE EINRICHTUNGEN

**GOMMA**

Ruota in legno di faggio con doppi anelli in gomma nera, ruota a foro liscio, antitraccia, silenziosa, corpo centrale: Nylon rinforzato con fibre di vetro

RACCOMANDATÒ PER LE CUCINE, OSPEDALI E PER ARREDAMENTO

Secteurs / Bereiche / Settori



BUREAU

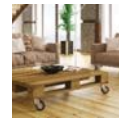

AGENCEMENT

Applications / Anwendung / Applicazioni



CARRELAGE  
FLIESEN  
PIASTRELLE



PARQUET BOIS  
HOLZ-PARKETT  
PARQUET



TAPIS  
TEPPICH  
MOQUETTE

Variantes / Varianten / Varianti



-10° - +40° C  
75 Sh/A



ROUE

ROUE / RAD / RUOTA

- Ø 50=CHF 12.90 (Ø 50x17mm, moy.20/8mm)
- Ø 60=CHF 16.10 (Ø 60x22mm, moy.25/8mm)
- Ø 75=CHF 17.80 (Ø 75x22mm, moy.25/8mm)
- Ø 100=CHF 23.00 (Ø 100x22mm, moy.25/8mm)



AVEC PLAQUE / MIT PLATTE / A PIASTRA

ROUE PIVOTANTE  
LENKROLLE  
RUOTA GIREVOLE



Prix  
Preis  
Prezzo

PIVOTANT/FREIN  
LENKROLLE/BREMS  
GIREVOLE/FRENO



Prix  
Preis  
Prezzo

ROUE FIXE  
BOCKROLLE  
RUOTA FISSA



Prix  
Preis  
Prezzo

AVEC TROU / MIT LOCH / A FORO

ROUE PIVOTANTE  
LENKROLLE  
RUOTA GIREVOLE



Prix  
Preis  
Prezzo

PIVOTANT/FREIN  
LENKROLLE/BREMS  
GIREVOLE/FRENO



Prix  
Preis  
Prezzo

ZINGUÉ_SERIE N° 3 'LEGER' (page 1.8)									
mm	mm	Page	kg	mm	mm	mm	mm	mm	mm
50	17	35	A) 60x60	A) 39x39 48x48	6.2	71	25	3121.05-bois	18.70
60	22	40	B) 60x60	39x39 48x48	6.2	82	25	3121.06-bois	24.40
75	22	50	B) 60x60	39x39 48x48	6.2	97	30	3121.07-bois	26.20
100	22	60	B) 60x60	39x39 48x48	6.2	121	32	3121.10-bois	31.90

A) ROULETTE FIXE, PLAQUE / BOCKROLLE, PLATTE / RUOTA FISSA, PIASTRA: 55x55 mm – 39x39 / 45x45 mm  
B) ROULETTE FIXE, PLAQUE / BOCKROLLE, PLATTE / RUOTA FISSA, PIASTRA: 67.5x60 mm – 39x39 / 48x48 mm

35 – 70 kg

**POLYURÉTHANE-ELASTIQUE**

Corps de roue en plastique avec bandage en polyurethane transparent (roue Ø 76/100) ou sombre (roue Ø 50), roue avec roulement à billes, roue de skate board

**POLYURETHAN-ELASTISCH**

Radkörper aus Kunststoff mit transparenter Polyurethanbereifung (Rad-Ø 76/100) oder mit dunkler Polyurethanbereifung (Rad-Ø 50), Rad mit Kugellager, Skate-Räder

**POLIURETANO-ELASTICA**

Corpo ruota in plastica con gomma in poliuretano trasparente (ruota Ø 76/100) o scuro (ruota Ø 50) ruota con cuscinetto a sfere, ruota per skateboard

Secteurs / Bereiche / Settori



SALLE DE SPORT  
SPORTHALLE  
CENTR. SPORTI



HOPITAL  
SPITAL  
HOSPITAL

Applications / Anwendung / Applicazioni

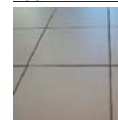

CARRELAGE  
FLIESEN  
PIASTRELLE



BETON  
BETON  
CEMENTO



GOUDRON  
ASPHALT  
ASFALTO

Variantes / Varianten / Varianti



-10° - +65° C  
70 Sh/A



ROUE

ROUE / RAD / RUOTA

- Ø 50=CHF 19.60 (Ø 50x21mm, moy.22/8mm)
- Ø 76=CHF 20.80 (Ø 76x23mm, moy.29/8mm)
- Ø 100=CHF 26.50 (Ø 100x24mm, moy.29/8mm)
- Ø 125=CHF 31.90 (Ø 125x24mm, moy.26/8mm)



ROUE \*C)

AVEC PLAQUE / MIT PLATTE / A PIASTRA

ROUE PIVOTANTE  
LENKROLLE  
RUOTA GIREVOLE



Prix  
Preis  
Prezzo

PIVOTANT/FREIN  
LENKROLLE/BREMS  
GIREVOLE/FRENO



Prix  
Preis  
Prezzo

ROUE FIXE  
BOCKROLLE  
RUOTA FISSA



Prix  
Preis  
Prezzo

AVEC TROU / MIT LOCH / A FORO

ROUE PIVOTANTE  
LENKROLLE  
RUOTA GIREVOLE



Prix  
Preis  
Prezzo

PIVOTANT/FREIN  
LENKROLLE/BREMS  
GIREVOLE/FRENO



Prix  
Preis  
Prezzo

ZINGUÉ_SERIE N° 3 'LEGER' (page 1.8)									
mm	mm	Page	kg	mm	mm	mm	mm	mm	mm
50	21	35	A) 60x60	A) 39x39 48x48	6.2	71	25	3113.05-skate	26.30
76	23	50	B) 60x60	39x39 48x48	6.2	97	30	3113.07-skate	28.80
100	24	70	B) 60x60	39x39 48x48	6.2	121	32	3113.10-skate	36.20

A) ROULETTE FIXE, PLAQUE / BOCKROLLE, PLATTE / RUOTA FISSA, PIASTRA: 55x55 mm – 39x39 / 45x45 mm  
B) ROULETTE FIXE, PLAQUE / BOCKROLLE, PLATTE / RUOTA FISSA, PIASTRA: 67.5x60 mm – 39x39 / 48x48 mm  
C) POLYURETHANE SOMBRE / DUNKLER POLYURETHAN / POLIURETANO SCURO



**ROULETTES POUR APPAREILS ET HÔPITAUX**

SUPPORT EN ACIER, ZINGUÉ-PROMATISÉ  
PIVOTEMENT SUR DOUBLE RANGÉE DE BILLES  
ROUE À PALIER LISSE, ROULEMENT À ROULEAUX OU À BILLES

**APPARATE- UND SPITAL-ROLLEN**

GEHÄUSE AUS STAHLBLECH, VERZINKT-PROMATISIERT  
SCHWENKLAGER MIT ZWEIFACHEM KUGELKRANZ  
RAD MIT GLEITLAGER, ROLLENLAGER ODER KUGELLAGER

**RUOTE PER ARREDAMENTO ED OSPEDALI**

SUPPORTI IN LAMIERA D'ACCIAIO, ZINCATO-CROMATO  
PIROETTAMENTO A DOPPIA CORONA DI SFERE  
RUOTA A FORO LISCIO, SU CUSCINETTO A RULLI E A SFERE

Les roulements à billes étanches 2RS permettent l'emploi même dans les secteurs où est prévue la **stérilisation vapeur d'appareillages jusqu'à +110°C**

2RS Spritzwassergeschützte Präzisionskugellager erlauben den Einsatz dieser Rollen selbst bei **Dampfsterilisation (+110°C)** und sichern das angestrebte Ziel einer leicht zu reinigenden Rolle

I cuscinetti a tenuta stagna 2RS consentono l'utilizzo anche in quei settori dove è prevista la **sterilizzazione delle apparecchiature con vapore fino a +110°C**

2RS water-proof ball bearings enables the use of these castors even when steam **sterilization up to +110°C is necessary**

Avec l'élimination de toutes parties métalliques visibles, ces roulettes sont particulièrement **résistantes à la corrosion**

Die eingesetzten Metallteile sind abgedeckt eingebaut, so dass die Rollen **weitgehend korrosionsbeständig sind**

Con l'eliminazione di ogni parte metallica a vista, queste ruote sono particolarmente **resistenti alla corrosione**

Any visible metal part being eliminated, these castors are **highly corrosion proof**

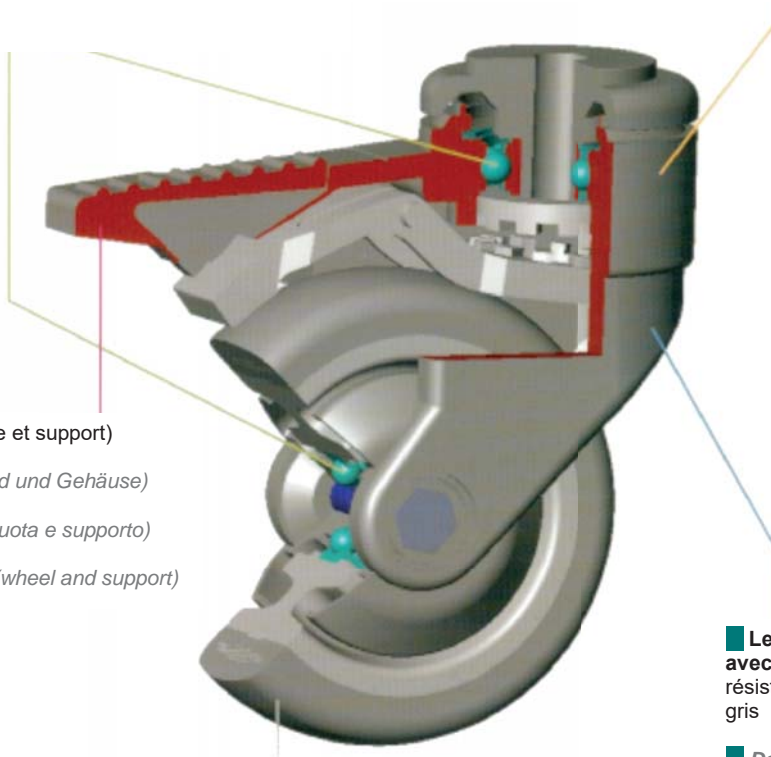

**Blocage double** (roue et support)

**Total-Feststeller** (Rad und Gehäuse)

**Freno simultaneo** (ruota e supporto)

**Total locking brake** (wheel and support)

Le support construit en nylon renforcé avec des fibres de verre particulièrement résistant aux flexions et aux chocs, couleur gris

Das mit glasfaserverstärktem Nylon ausgeführte Gehäuse ist selbst unter extremer Stossbelastung enorm schlagzäh und verformungsstabil, Farbe grau

Il supporto realizzato in nylon rinforzato con fibre di vetro, particolarmente resistente alle flessioni ed agli urti, colore grigia

The nylon fiber-glass reinforced support can resist to flexions and moves very well which enables it to get through the heaviest tests, colour grey

Avec une roue en **CAOUTCHOUC**, en **POLYURETHANE**, en **CAOUTCHOUC ANTISTATIQUE** ou à PNEU, silencieux, non-tachant

Mit einem **GUMMIRAD**, **POLYURETHAN-RAD**, **ANTISTATISCHEM-GUMMIRAD** oder mit **REIFEN**, Laufruhe, spurfrei

Ruote in **GOMMA**, in **POLYURETHANE**, in **GOMMA-ANTISTATIC**, in **PNEUMATICA**, silensio, antitraccia

With **SANTOPREN-RUBBER**, **POLYURETHAN-RUBBER**, **ANTISTATIC-RUBBER** and **PNEUMATIC-RUBBER**, non-marking



HÔPITAL  
SPITAL  
OSPEDALE



SALLE POLYVALENTE  
MEHRZWECKHALLE  
CENTRO SPORTIVO



AMENAGEMENT  
EINRICHTUNG  
ARREDAMENTO



CUISINE  
KÜCHE  
CUCINA



ALIMENTATION  
LEBENSMITTEL  
ALIMENTAZIONE

**RABAIS / RABATT / SCONTO : 20% dès/ab/da 100.-- (CHF) / 25% dès/ab/da 500.-- (CHF)**  
RABAIS DE QUANTITE SUR DEMANDE ! MENGENRABATT AUF ANFRAGE ! SCONTO DI QUANTITA SU RICHIESTA !

**ROULETTES POUR APPAREILS ET HÔPITAUX**

SUPPORT EN ACIER, ZINGUÉ-PROMATISÉ  
PIVOTEMENT SUR DOUBLE RANGÉE DE BILLES  
ROUE À PALIER LISSE, ROULEMENT À ROULEAUX OU À BILLES

**APPARATE- UND SPITAL-ROLLEN**

GEHÄUSE AUS STAHLBLECH, VERZINKT-PROMATISIERT  
SCHWENKLAGER MIT ZWEIFACHEM KUGELKRANZ  
RAD MIT GLEITLAGER, ROLLENLAGER ODER KUGELLAGER

**RUOTE PER ARREDAMENTO ED OSPEDALI**

SUPPORTI IN LAMIERA D'ACCIAIO, ZINCATO-CROMATO  
PIROETTAMENTO A DOPPIA CORONA DI SFERE  
RUOTA A FORO LISCIO, SU CUSCINETTO A RULLI E A SFERE

100 – 120 kg

**CAOUTCHOUC/Thermoplastique**

Roue Caoutchouc Thermoplastique, gris, roue avec roulement à billes, non-tachant, silencieux, corps/roue: Nylon renforcé de fibres de verre

RECOMMANDÉ POUR LES CUISINES, LES HOPITAUX ET LES AGENCEMENTS

**GUMMI/Thermoplastisch**

Gummirad Thermoplastisch, grau, Rad mit Gleitlager oder Kugellager, spurfrei, Laufruhe, Radkörper: Nylon und Glasfaser Verbindung

EMPFOLHEN FÜR DIE KÜCHEN, DIE SPITAL UND DIE EINRICHTUNGEN

**GOMMA/Termoplastica**

Ruota in Gomma Termoplastica, grigia, ruota a foro liscio o su cuscinetti a sfere, antiraccia, silenziosa, corpo centrale: Nylon rinforzato con fibre di vetro

RACCOMANDATÒ PER LE CUCINE, OSPEDALI E PER ARREDAMENTO

Secteurs / Bereiche / Settori



HOPITAL  
SPITAL  
OSPEDALE



CUISINE  
KÜCHE  
CUCINA

Applications / Anwendung / Applicazioni



CARRELAGE  
FLIESEN  
PIASTRELLE



PARQUET BOIS  
HOLZ-PARKETT  
PARQUET



INDUSTRIE  
INDUSTRIE  
INDUSTRIA

Variantes / Varianten / Varianti



-20° - +80° C  
87 Sh/A



ROUE  
PAGE 7.1  
50 – 310 kg



SERIE 2..-3..  
PAGE 3.1-2  
50 – 120 kg



SERIE 5..-8..  
PAGE 5.1-2  
90 – 310 kg

AVEC PLAQUE / MIT PLATTE / A PIASTRA

AVEC TROU / MIT LOCH / A FORO

NYLON_SERIE N° H 'MEDIA' (page 1.8)								NYLON-SPECIAL / SPEZIAL-NYLON / NYLON-SPECIALE											
mm	mm	Page 1.6	kg	mm	mm	mm	mm	Art. N :	CHF sans TVA	Art. N :	CHF sans TVA	Art. N :	CHF sans TVA	mm	Art. N :	CHF sans TVA	Art. N :	CHF sans TVA	
100	32	100	77x67	50x40	61x51	8.5	145	38	H-2113.10	37.10	H-2213.10	43.00	---	A) 10.2	H-2013.10	31.90	H-2713.10	37.50	
100	32	100	77x67	50x40	61x51	8.5	145	38	H-2113.10-S	41.80	H-2213.10	47.70	---	A) 10.2	H-2013.10	36.60	H-2713.10	42.20	
125	32	110	77x67	50x40	61x51	8.5	165	47	H-2113.12	42.10	H-2213.12	47.70	---	A) 10.2	H-2013.12	35.50	H-2713.12	42.30	
125	32	110	77x67	50x40	61x51	8.5	165	47	H-2113.12-S	46.90	H-2213.12-S	53.00	---	A) 10.2	H-2013.12-S	40.00	H-2713.12-S	47.30	
150	32	120	90x70	70x50	75x45	8.5	195	49	H-2113.15	59.80	H-2213.15	67.80	---	A) 10.2	H-2013.15	54.10	H-2713.15	62.50	

80 kg

**PNEU-SOFT**

Pneu plein en Polyuréthane-SOFT, gris, roue avec roulement à billes, non-tachant, silencieux, extra-souple, corps/roue: Nylon renforcé de fibres de verre

EXTRA-SOUPLE ET INCREVABLE

**SOFT-REIFEN**

Vollreifen aus Polyurethan-SOFT, grau, Rad mit Kugellager, spurfrei, Laufruhe, extra-weich, Radkörper: Nylon und Glasfaser Verbindung

EXTRA-WEICH UND PANNENSICHER

**PNEUMATICHE-SOFT**

Pneumatica in Poliuretano-SOFT, grigia, ruota su cuscinetti a sfere, antiraccia, silenziosa, grande elasticità, corpo centrale: Nylon rinforzato con fibra di vetro

GRANDE ELASTICITÀ ED A PROVA DI FORATURA

Secteurs / Bereiche / Settori



CUISINE  
KÜCHE  
CUCINA



HOPITAL  
SPITAL  
OSPEDALE

Applications / Anwendung / Applicazioni



CARRELAGE  
FLIESEN  
PIASTRELLE

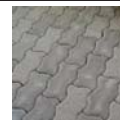

PAVE  
PLASTER-STEIN  
PAVIMENTO



SOL ACIER  
STAHL  
ACCIAIO

Variantes / Varianten / Varianti



-20° - +60° C  
50-60 Sh/A



ROUE  
PAGE 7.6  
120 – 140 kg



SERIE 2..  
PAGE 3.3  
80 kg



SERIE 5..-8..  
PAGE 5.9  
120 – 140 kg

AVEC PLAQUE / MIT PLATTE / A PIASTRA

AVEC TROU / MIT LOCH / A FORO

NYLON_SERIE N° H 'MEDIA' (page 1.8)								NYLON-SPECIAL / SPEZIAL-NYLON / NYLON-SPECIALE											
mm	mm	Page 1.6	kg	mm	mm	mm	mm	Art. N :	CHF sans TVA	Art. N :	CHF sans TVA	Art. N :	CHF sans TVA	mm	Art. N :	CHF sans TVA	Art. N :	CHF sans TVA	
100	32	80	77x67	50x40	61x51	8.5	145	38	H-21 SOF.10	67.30	H-22 SOF.10	75.30	---	A) 10.2	H-20 SOF.10	62.20	H-27 SOF.10	69.70	
125	32	80	77x67	50x40	61x51	8.5	165	47	H-21 SOF.12	73.90	H-22 SOF.12	82.30	---	A) 10.2	H-20 SOF.12	67.90	H-27 SOF.12	76.90	
150	32	80	90x70	70x50	75x45	8.5	195	49	H-21 SOF.15	61.60	H-22 SOF.15	69.90	---	A) 10.2	H-20 SOF.15	56.00	H-27 SOF.15	64.40	
200	32	80	90x70	70x50	75x45	8.5	251	67	H-21 SOF.20	74.70	H-22 SOF.20	84.80	---	A) 10.2	H-20 SOF.20	68.90	H-27 SOF.20	79.00	

A) EGALEMENT AVEC TROU 12,3mm / AUCH MIT LOCH 12,3mm / ANCHE A FORO 12,3mm  
B) ROULETTE AVEC PLAQUE, HAUTEUR +7mm / ROLLEN MIT PLATTE, BAUHÖHE +7mm / RUOTA A PIASTRA, ALTEZZA UTILE +7mm  
C) PLAQUE\_ZINGUÉ / PLATTE\_VERZINKT / PIASTRA\_ZINCATO = 77x67mm, 90x70mm | PLAQUE\_INOX / PLATTE\_ROSTFREI / PIASTRA\_INOX = 77x67mm, 80x80mm 90x70mm +CHF 9.00  
D) AVEC CAOUTCHOUC-ELASTIQUE 75 Sh/A / MIT ELASTISCHE-GUMMI 75Sh/A / CON GOMMA-ELASTIK 75 Sh/A



**ROULETTES POUR APPAREILS ET HÔPITAUX**

SUPPORT EN ACIER, ZINGUÉ-PROMATISÉ  
PIVOTEMENT SUR DOUBLE RANGÉE DE BILLES  
ROUE À PALIER LISSE, ROULEMENT À ROULEAUX OU À BILLES

**APPARATE- UND SPITAL-ROLLEN**

GEHÄUSE AUS STAHLBLECH, VERZINKT-PROMATISIERT  
SCHWENKLAGER MIT ZWEIFACHEM KUGELKRANZ  
RAD MIT GLEITLAGER, ROLLENLAGER ODER KUGELLAGER

**RUOTE PER ARREDAMENTO ED OSPEDALI**

SUPPORTI IN LAMIERA D'ACCIAIO, ZINCATO-CROMATO  
PIROETTAMENTO A DOPPIA CORONA DI SFERE  
RUOTA A FORO LISCIO, SU CUSCINETTO A RULLI E A SFERE

100 – 120 kg

**POLYURÉTHANE**

Roue Polyuréthane injecté, gris, roue avec roulement à billes, non-tachant, silencieux corps/roue: Nylon 6 renforcé de fibres de verre, résistant aux huiles/grasses/essences...  
**RECOMMANDÉ POUR LES INDUSTRIES ET LES AGENCEMENTS**

**POLYURETHAN**

Rad mit Spritzguss-Polyurethan, grau, Rad mit Kugellager, spurfrei, Laufruhe beständigkeit gegen Oel/Fett/Benzin..., Radkörper: Nylon und Glasfaser verbinding  
**EMPFOHLEN FÜR INDUSTRIE UND DIE EINRICHTUNGEN**

**POLIURETANO**

Ruota rivestimento in Poliuretano iniettato, grigia, ruota su cuscinetti a sfere, antitraccia, silencia, resistendo agli oli/grassi/petroli..., corpo centrale: Nylon rinforzato con fibra di vetro  
**RACCOMANDATÒ PER INDUSTRIA E PER ARREDAMENTO**

**Secteurs / Bereiche / Settori**



HUILE/ESSENCE  
OEL/BENZIN  
OLII/PETROLI



USINE  
FABRIK  
INDUSTRIA

**Applications / Anwendung / Applicazioni**



BETON  
BETON  
CEMENTO

INDUSTRIE  
INDUSTRIE  
INDUSTRIA

TAPIS  
TEPPICH  
MOQUETTE

**Variantes / Varianten / Varianti**



-25° - +80° C  
85 Sh/A



ROUE  
PAGE 7.7  
60 – 490 kg



SERIE 2..-3..  
PAGE 3.5  
60 – 120 kg



SERIE 5..-8..  
PAGE 5.11-12  
120 – 480 kg



SERIE 9..-TH..  
PAGE 6.3  
390 – 950 kg

**AVEC PLAQUE / MIT PLATTE / A PIASTRA**

**AVEC TROU / MIT LOCH / A FORO**

NYLON_SERIE N° H 'MEDIA' (page 1.8)										NYLON-SPÉCIAL / SPEZIAL-NYLON / NYLON-SPECIALE																				
mm	mm	Page 1.6	kg	mm	mm	mm	mm	mm	mm	ROUE PIVOTANTE LENKROLLE RUOTA GIREVOLE	Prix Preis Prezzo	Art. N :	CHF sans TVA	PIVOTANT/FREIN LENKROLLE/BREMS GIREVOLE/FRENO	Prix Preis Prezzo	Art. N :	CHF sans TVA	ROUE FIXE BOCKROLLE RUOTA FISSA	Prix Preis Prezzo	Art. N :	CHF sans TVA	mm	ROUE PIVOTANTE LENKROLLE RUOTA GIREVOLE	Prix Preis Prezzo	Art. N :	CHF sans TVA	PIVOTANT/FREIN LENKROLLE/BREMS GIREVOLE/FRENO	Prix Preis Prezzo	Art. N :	CHF sans TVA
100	32			100	<sup>C)</sup> 77x67	50x40 61x51	8.5	<sup>B)</sup> 145	38	H-2173.10	40.90	H-2273.10	46.70	---				<sup>A)</sup> 10.2	H-2073.10	35.40	H-2773.10	41.10								
125	32			110	<sup>C)</sup> 77x67	50x40 61x51	8.5	<sup>B)</sup> 165	47	H-2173.12	46.70	H-2273.12	52.40	---				<sup>A)</sup> 10.2	H-2073.12	40.20	H-2773.12	47.20								
150	32			120	<sup>C)</sup> 90x70	70x50 75x45	8.5	<sup>B)</sup> 195	49	H-2173.15	67.20	H-2273.15	75.50	---				<sup>A)</sup> 10.2	H-2073.15	61.90	H-2773.15	70.10								

100 – 120 kg

**POLYURÉTHANE-ANTISTATIQUE**

Roue Polyuréthane Thermoplastique, gris, roue avec roulement à billes, non-tachant, silencieux corps/roue: Nylon renforcé de fibres de verre, résistant aux huiles/grasses/essences...  
**AVEC ROUES ANTISTATIQUES, RECOMMANDÉ POUR LES HÔPITAUX ET L'INDUSTRIE**

**POLYURETHAN-ANTISTATISCH**

Rad mit Spritzguss-Polyurethan, grau, Rad mit Kugellager, spurfrei, Laufruhe beständigkeit gegen Oel/Fett/Benzin..., Radkörper: Nylon und Glasfaser verbinding  
**MIT ANTISTATISCH-RÄDERN, EMPFOHLEN FÜR SPITAL UND INDUSTRIE**

**POLIURETANO-ANTISTATICO**

Ruota rivestimento in Poliuretano iniettato, grigia, ruota su cuscinetti a sfere, antitraccia, silencia, resistendo agli oli/grassi/petroli..., corpo centrale: Nylon rinforzato con fibra di vetro  
**CON ANTISTATICO-RUOTE, RACCOMANDATÒ PER OSPEDALI ED INDUSTRIA**

**Secteurs / Bereiche / Settori**



HUILE/ESSENCE  
OEL/BENZIN  
OLII/PETROLI



HOPITAL  
SPITAL  
OSPEDALE

**Applications / Anwendung / Applicazioni**



ANTISTATIQUE  
ANTISTATISCH  
ANTISTATICO

CARRELAGE  
FLIESEN  
PIASTRELLE

INDUSTRIE  
INDUSTRIE  
INDUSTRIA

**Variantes / Varianten / Varianti**



-25° - +80° C  
87 Sh/A



ROUE  
PAGE 7.8  
60 – 490 kg



SERIE 2..-3..  
PAGE 3.6  
60 – 120 kg



SERIE 5..-8..  
PAGE 5.13-14  
120 – 480 kg



SERIE 9..-TH..  
PAGE 6.4  
390 – 950 kg

**AVEC PLAQUE / MIT PLATTE / A PIASTRA**

**AVEC TROU / MIT LOCH / A FORO**

NYLON_SERIE N° H 'MEDIA' (page 1.8)										NYLON-SPÉCIAL / SPEZIAL-NYLON / NYLON-SPECIALE																				
mm	mm	Page 1.6	kg	mm	mm	mm	mm	mm	mm	ROUE PIVOTANTE LENKROLLE RUOTA GIREVOLE	Prix Preis Prezzo	Art. N :	CHF sans TVA	PIVOTANT/FREIN LENKROLLE/BREMS GIREVOLE/FRENO	Prix Preis Prezzo	Art. N :	CHF sans TVA	ROUE FIXE BOCKROLLE RUOTA FISSA	Prix Preis Prezzo	Art. N :	CHF sans TVA	mm	ROUE PIVOTANTE LENKROLLE RUOTA GIREVOLE	Prix Preis Prezzo	Art. N :	CHF sans TVA	PIVOTANT/FREIN LENKROLLE/BREMS GIREVOLE/FRENO	Prix Preis Prezzo	Art. N :	CHF sans TVA
100	32			100	<sup>C)</sup> 77x67	50x40 61x51	8.5	<sup>B)</sup> 145	38	H-2173.10-A	49.60	H-2273.10-A	55.90	---				<sup>A)</sup> 10.2	H-2073.10-A	44.10	H-2773.10-A	50.00								
125	32			110	<sup>C)</sup> 77x67	50x40 61x51	8.5	<sup>B)</sup> 165	47	H-2173.12-A	59.10	H-2273.12	64.60	---				<sup>A)</sup> 10.2	H-2073.12-A	52.50	H-2773.12-A	59.40								
150	32			120	<sup>C)</sup> 90x70	70x50 75x45	8.5	<sup>B)</sup> 195	49	H-2173.15-A	84.70	H-2273.15-A	92.80	---				<sup>A)</sup> 10.2	H-2073.15-A	79.20	H-2773.15-A	87.50								
200	32			120	<sup>C)</sup> 90x70	70x50 75x45	8.5	<sup>B)</sup> 251	67	H-2173.20-A	101.10	H-2273.20-A	111.00	---				<sup>A)</sup> 10.2	H-2073.20-A	95.50	H-2773.20-A	105.10								

A) EGALEMENT AVEC TROU 12,3mm / AUCH MIT LOCH 12,3mm / ANCHE A FORO 12,3mm  
B) ROULETTE AVEC PLAQUE, HAUTEUR +7mm / ROLLEN MIT PLATTE, BAUHÖHE +7mm / RUOTA A PIASTRA, ALTEZZA UTILE +7mm  
C) PLAQUE\_ZINGUÉ / PLATTE\_VERZINKT / PIASTRA\_ZINCATO = 77x67mm, 90x70mm | PLAQUE\_INOX / PLATTE\_ROSTFREI / PIASTRA\_INOX = 77x67mm, 80x80mm 90x70m +CHF 9.00

**RABAIS / RABATT / SCONTO : 20% dès/ab/da 100.-- (CHF) / 25% dès/ab/da 500.-- (CHF)**  
RABAIS DE QUANTITE SUR DEMANDE ! MENGENRABATT AUF ANFRAGE ! SCONTO DI QUANTITA SU RICHIESTA !



**ROULETTES POUR APPAREILS ET HÔPITAUX**

SUPPORT EN ACIER, ZINGUÉ-PROMATISÉ  
PIVOTEMENT SUR DOUBLE RANGÉE DE BILLES  
ROUE À PALIER LISSE, ROULEMENT À ROULEAUX OU À BILLES

**APPARATE- UND SPITAL-ROLLEN**

GEHÄUSE AUS STAHLBLECH, VERZINKT-PROMATISIERT  
SCHWENKLAGER MIT ZWEIFACHEM KUGELKRANZ  
RAD MIT GLEITLAGER, ROLLENLAGER ODER KUGELLAGER

**RUOTE PER ARREDAMENTO ED OSPEDALI**

SUPPORTI IN LAMIERA D'ACCIAIO, ZINCATO-CROMATO  
PIROETTAMENTO A DOPPIA CORONA DI SFERE  
RUOTA A FORO LISCIO, SU CUSCINETTO A RULLI E A SFERE

>> PAGE / SEITE / PAGINA >2.9 + 3.13 + 4.7 + 5.21

**RABAIS SPÉCIAL 25%**

**SET-SUPERMARCHÉ** (4 pces, au choix)

**SPEZIAL-RABATT 25%**

**SET-SUPERMARKET** (4 Stk, nach wahl)

**SCONTO SPECIALE 25%**

**SET-SUPERMARKET** (4 pz, a scelta)

ACTION



**ROULETTE POUR SUPERMARCHÉ**

**SUPERMARKET-ROLLEN**

**RUOTE PER CARRELLI SUPERMARKET**



SERIE N° 2 'MEDIA' (page 1.8)							ROUE PIVOTANTE LENKROLLE RUOTA GIREVOLE		ROUE PIVOTANTE LENKROLLE RUOTA GIREVOLE		ROUE PIVOTANTE LENKROLLE RUOTA GIREVOLE		ROUE RÄDER RUOTA		ROUE RÄDER RUOTA			
mm	mm	Page 1.6	kg	mm	mm	mm	Art. N :	CHF sans TVA	Art. N :	CHF sans TVA	Art. N :	CHF sans TVA	mm	mm	Art. N :	CHF sans TVA	Art. N :	CHF sans TVA
50	19		50	10.2	71	25	3011.05	9.40	---	---	---	---	22	8 (6)	11.05x19	3.90	---	---
100	32		100	10.2/12.2	145	38	---	---	---	---	H-2013.10	31.90	40	8	H-13.10x32	15.80	---	---
125	32		100	10.2/12.2	148	35	2013.12-MARK	23.20	2013.12-ESCA	40.30	H-2013.12	35.50	40	8	13.12x32-MARK	12.00	13.12x32-ESCA	27.70

A) H-2013.12 = 165mm

AUTRES GRANDEURS DISPONIBLES / ANDERE VERFÜGBAREN GRÖßEN / ALTRE DIMENSIONI DISPONIBILI

	PLAQUE 35x15mm +CHF 9.00
	PLATTE 35x15mm +CHF 6.50
	PIASTRA 35x15mm +CHF 6.50
	VIS M10/12 x25mm +CHF 2.00
	SCHRAUBE M10/12 x25mm +CHF 2.00
	VITE M10/12 x25mm +CHF 2.00



>> PAGE / SEITE / PAGINA >2.9 + 3.13 + 4.7 + 5.21

**RABAIS SPÉCIAL 25%**

**SET-CHAISE ROULANTE** (4 pces, au choix)

**SPEZIAL-RABATT 25%**

**SET-ROLLSTUHL** (4 Stk, nach wahl)

**SCONTO SPECIALE 25%**

**SET-CARROZZINE** (4 pz, a scelta)

ACTION



**ROUES POUR CHAISE ROULANTE**

**RÄDER FÜR ROLLSTUHL**

**RUOTE PER CARROZZINE**

SERIE N° 2 'MEDIA' (page 1.8)							ROUE PIVOTANTE LENKROLLE RUOTA GIREVOLE		ROUE PIVOTANTE LENKROLLE RUOTA GIREVOLE		ROUE RÄDER RUOTA		ROUE RÄDER RUOTA		ROUE RÄDER RUOTA		BANDAGE BANDAGE ANELLI			
mm	mm	Page 1.6	kg	mm	mm	mm	Art. N :	CHF sans TVA	Art. N :	CHF sans TVA	Art. N :	CHF sans TVA	mm	mm	Art. N :	CHF sans TVA	Art. N :	CHF sans TVA	Art. N :	CHF sans TVA
175	45		120	12.2	235	35	20 DCK 17	54.10	---	---	---	---	50/60	12/8	DCK 17x45	37.20	---	---	---	---
200	50 / 32		120	12.2	235	35	20 DCK 20	62.50	20 SOF 20	51.60	---	---	50/60	12/8	DCK 20x50	42.10	SOF 20x32	33.80	---	---
615	32		120	MOYEU 60/12mm, 24x1 3/8			---	---	---	---	SOF 615x32	113.70	24 x 1 3/8		---	---	---	---	SOF-P.615	62.80



**ROULETTES POUR MACHINES**

**MASCHINEN-ROLLEN**

**RUOTE PER MACCHINE**

**4**



**80 – 600 kg**



**50 - 200 mm**

SECTEURS / BEREICHE / SETTORI



INDEX / INHALT / INDICE



**PAGE 4.1**  
POLYAMIDE  
POLYAMID  
POLIAMMIDE



**PAGE 4.3**  
NYLON 6  
NYLON 6  
NYLON 6



**PAGE 4.4**  
POLYURETHANE  
POLYURETHAN  
POLIURETANO



**PAGE 4.5**  
POLYURETHANE  
POLYURETHAN  
POLIURETANO



**PAGE 4.6**  
FONTE  
GUSS  
GHISA



**PAGE 4.7**  
PIED POSITION  
GELENKFUSSE  
PIEDE POSIZIONE



**PAGE 4.2**  
NYLON 6  
NYLON 6  
NYLON 6



**PAGE 4.3**  
CAOUTCH-ELAST  
GUMMI-ELAST  
GOMMA-ELAST



**PAGE 4.4**  
POLYURETHANE  
POLYURETHAN  
POLIURETANO



**PAGE 4.5**  
POLYURETHANE  
POLYURETHAN  
POLIURETANO



**PAGE 4.6**  
TORTUE  
SCHILDKROTE  
TARTARUGA



**PAGE 4.7**  
ACTION - AKTION  
TRANSPALETTE  
PALETTENHUBWAG

**WEMAS Sàrl - CH-2720 TRAMELAN**

ROUES-ROULETTES / RÄDER-ROLLEN / RUOTE-ROTELLE / WHEELS-CASTORS

TELEPHONE 032 487 43 28 / FAX 032 487 44 43

INTERNET [www.wemas.ch](http://www.wemas.ch) / E-MAIL [info@wemas.ch](mailto:info@wemas.ch)



**ROULETTES POUR MACHINES A CHARGES ELEVEES**

SUPPORT EN ACIER, INDEFORMABLE, PROMAT-ZINGUE  
LARGE PALIER DE PIVOTEMENT EN ACIER TREMPÉ RENFORCÉ  
ROUE A PALIER LISSE, ROULEMENT A ROULEAUX OU A BILLES

**SCHWERLASTROLLEN FÜR MASCHINEN**

GEHÄUSE AUS STAHL, VERSCHLEISSFEST, PROMAT-VERZ.  
BREITES SCHWENKLAGER AUS GEHÄRTETEM STAHL  
RAD MIT GLEITLAGER, ROLLENLAGER ODER KUGELLAGER

**RUOTE PER MACCHINE A CARICHI GRAVOSI**

SUPPORTI IN LAMIERA D'ACCIAIO, INALTERABILE, ZINCATO  
GRANDE PIROETTAMENTO SU PISTE D'ACCIAIO TEMPERATO  
RUOTA A FORO LISCIO, SU CUSCINETTO A RULLI E A SFERE

**80 – 190 kg**

**POLYAMIDE / NYLON 6**

Roue Polyamide/Nylon 6, blanc, roue à palier lisse ou avec roulement à rouleaux non-tachant, corps/roue: Nylon 6

**RÉSISTANT AUX HUILES/GRAISSES/ESSENCES...**

**POLYAMID / NYLON 6**

Polyamid-Rad/Nylon 6, weiss, Rad mit Gleitlager oder Rollenlager spurfrei, Radkörper: Nylon 6

**BESTÄNDIGKEIT GEGEN OEL/FETT/BENZIN...**

**POLIAMMIDE / NYLON 6**

Ruota in Poliammide/Nylon 6, bianco, ruota a foro liscio e su cuscinetto a rulli antitraccia, corpo centrale: Nylon 6

**RESISTENDO AGLI OLI/GRASSI/PETROLI...**

**Secteurs / Bereiche / Settori**



HUILE/ESSENCE  
OEL/BENZIN  
OLIV/PETROLI



USINE  
FABRIK  
INDUSTRIA

**Applications / Anwendung / Applicazioni**



INDUSTRIE  
INDUSTRIE  
INDUSTRIA



BETON  
BETON  
CEMENTO



TAPIS  
TEPPICH  
MOQUETTE

**Variantes / Varianten / Varianti**



-30° - +100° C  
NYLON 6



**ROUE**  
PAGE 7.13-14  
55 – 2500 kg



**SERIE 2..-3..**  
PAGE 3.8  
50 – 110 kg



**SERIE 5..-8..**  
PAGE 5.17-19  
130 – 480 kg



**SERIE 9..-TH..**  
PAGE 6.9-10  
700 – 2700 kg

**AVEC PLAQUE / MIT PLATTE / A PIASTRA**

**AVEC TROU / MIT LOCH / A FORO**

ZINGUÉ_SERIE N° TL 'FORT' (page 1.10)										ROUE PIVOTANTE LENKROLLE RUOTA GIREVOLE		PIVOTANT/FREIN LENKROLLE/BREMS GIREVOLE/FRENO		ROUE FIXE BOCKROLLE RUOTA FISSA		ROUE PIVOTANTE LENKROLLE RUOTA GIREVOLE		PIVOTANT/FREIN LENKROLLE/BREMS GIREVOLE/FRENO			
mm	mm	Page 1.6	kg	mm	mm	mm	mm	mm	mm	Art. N :	Prix Preis Prezzo CHF sans TVA	Art. N :	Prix Preis Prezzo CHF sans TVA	Art. N :	Prix Preis Prezzo CHF sans TVA	mm	Art. N :	Prix Preis Prezzo CHF sans TVA	Art. N :	Prix Preis Prezzo CHF sans TVA	
50	20		80	89x59	73x23 55x40	8.5	<sup>B)</sup> 74	28		TL 22 NY	16.40	---		TR 22 NY	12.50	A) 8	SD 22 NY	13.10	---		
63	25		120	110x80	89x51 80x60	8.5	<sup>B)</sup> 90	32		TL 325 NY	21.30	---		TR 325 NY	14.20	12.5	SD 325 NY	17.00	---		
75	25		130	110x80	89x51 80x60	8.5	<sup>B)</sup> 104	35		TL 33 NY	23.10	---		TR 33 NY	16.20	12.5	SD 33 NY	19.00	---		
75	35		190	115x85	87x60 80x60	8.5	<sup>B)</sup> 110	36		TL 43 NY	34.90	---		TR 43 NY	21.60	12.5	SD 43 NY	29.00	---		

A) EGALEMENT AVEC TROU 10mm / AUCH MIT LOCH 10mm / ANCHE CON FORO 10mm

B) ROULETTE AVEC PLAQUE, HAUTEUR +4mm / ROLLEN MIT PLATTE, BAUHÖHE +4mm / RUOTA A PIASTRA, ALTEZZA UTILE +4mm





**ROULETTES POUR MACHINES A CHARGES ELEVEES**

SUPPORT EN ACIER, INDEFORMABLE, PROMAT-ZINGUE  
LARGE PALIER DE PIVOTEMENT EN ACIER TREMPÉ RENFORCÉ  
ROUE A PALIER LISSE, ROULEMENT A ROULEAUX OU A BILLES

**SCHWERLASTROLLEN FÜR MASCHINEN**

GEHÄUSE AUS STAHL, VERSCHLEISSFEST, PROMAT-VERZ  
BREITES SCHWENKLAGER AUS GEHÄRTETEM STAHL  
RAD MIT GLEITLAGER, ROLLENLAGER ODER KUGELLAGER

**RUOTE PER MACCHINE A CARICHI GRAVOSI**

SUPPORTI IN LAMIERA D'ACCIAIO, INALTERABILE, ZINCATO  
GRANDE PIROETTAMENTO SU PISTE D'ACCIAIO TEMPERATO  
RUOTA A FORO LISCI, SU CUSCINETTO A RULLI E A SFERE

**180 – 650 kg****POLYAMIDE / NYLON 6**

Roue Polyamide/Nylon 6, noir, roue à palier lisse ou avec roulement à rouleaux non-tachant, corps/roue: Nylon 6 renforcé de fibres de verre

**RÉSISTANT AUX HUILES/GRAISSES/ESSENCES...**

**POLYAMID / NYLON 6**

Polyamid-Rad/Nylon 6, schwarz, Rad mit Gleitlager oder Rollenlager spurfrei, Radkörper: Nylon 6 und Glasfaser Verbindung

**BESTÄNDIGKEIT GEGEN OEL/FETT/BENZIN...**

**POLIAMMIDE / NYLON 6**

Ruota in Poliammide/Nylon 6, nero, ruota a foro liscio e su cuscinetto a rulli antitraccia, corpo centrale: Nylon 6 rinforzato con fibre di vetro

**RESISTENDO AGLI OLI/GRASSI/PETROLI...**

**Secteurs / Bereiche / Settori**

HUILE/ESSENCE  
OEL/BENZIN  
OLI/PETROLI



USINE  
FABRIK  
INDUSTRIA

**Applications / Anwendung / Applicazioni**

INDUSTRIE  
INDUSTRIE  
INDUSTRIA



BETON  
BETON  
CEMENTO



TAPIS  
TEPPICH  
MOQUETTE

**Variantes / Varianten / Varianti**

-30° - +100° C  
NYLON 6



ROUE  
PAGE 7.13-14  
55 – 2500 kg

**AVEC PLAQUE / MIT PLATTE / A PIASTRA****AVEC TROU / MIT LOCH / A FORO**

								ROUE PIVOTANTE LENKROLLE RUOTA GIREVOLE		PIVOTANT/FREIN LENKROLLE/BREMS GIREVOLE/FRENO		ROUE FIXE BOCKROLLE RUOTA FISSA				ROUE PIVOTANTE LENKROLLE RUOTA GIREVOLE		PIVOTANT/FREIN LENKROLLE/BREMS GIREVOLE/FRENO	
mm	mm	Page 1.6	kg	mm	mm	mm	mm	Art. N :	Prix Preis Prezzo CHF sans TVA	Art. N :	Prix Preis Prezzo CHF sans TVA	Art. N :	Prix Preis Prezzo CHF sans TVA	mm	Art. N :	Prix Preis Prezzo CHF sans TVA	Art. N :	Prix Preis Prezzo CHF sans TVA	
<b>ZINGUÉ SERIE N° 34 'FORT' (page 1.10)</b>																			
A) 50	2x19		180	96x65	75x45	7.5	60/70	24	---	---	---	---	---	---	3400-2x71.05	32.80	---	---	
50	35		150	96x65	75x45	7.5	60/70	24	3400 NN.05	29.00	---	---	3408 NN.05 H70	27.90	---	---	---	---	
63	35		180	95x70	76x44/45	8.5	B) 89	22	3400 NN.06	42.30	---	---	3408 NN.06 H78	30.30	---	---	---	---	
76	46		380	C) 110x85	C) 85x60	8.5	101	22	3400 NN.071-R	54.30	3407 NN.071-R	105.90	3408 NN.071-R	41.90	---	---	---	---	
76	46		400	C) 110x85	C) 85x60	8.5	101	22	3400 NN.071-K	105.00	3407 NN.071-K	135.20	3408 NN.071-K	93.00	---	---	---	---	
76	46		650	C) 110x85	C) 85x60	8.5	105	22	3400 NN.072	93.30	---	---	3408 NN.072	69.00	---	---	---	---	

A) ROULETTE JUMELÉE EN POLYURÉTHANE / ZWILLINGS-LENKROLLEN AUS POLYURETHAN / DOPPIA RUOTE IN POLIURETANO

B) EGALEMENT AVEC HAUTEUR 78mm / AUCH MIT BAUHÖHE 78mm / ANCHE CON ALTEZZA UTILE 78mm

C) ROULETTE FIXE, PLAQUE 105X65mm, TROU FIXATION 86X50mm / BOCKROLLE, PLATTE 105X65mm, LOCHABSTAND 86X50mm / RUOTA FISSA, PIASTRA 105X65mm, INTERASSE FORI 86X50mm



**RABAIS / RABATT / SCONTO :**

RABAIS DE QUANTITE SUR DEMANDE !

**20%** dès/ab/da **100.--** (CHF)

MENGENRABATT AUF ANFRAGE !

**25%** dès/ab/da **500.--** (CHF)

SCONTO DI QUANTITA SU RICHIESTA !

**ROULETTES POUR MACHINES A CHARGES ELEVEES**

SUPPORT EN ACIER, INDEFORMABLE, PROMAT-ZINGUE  
LARGE PALIER DE PIVOTEMENT EN ACIER TREMPÉ RENFORCÉ  
ROUE A PALIER LISSE, ROULEMENT A ROULEAUX OU A BILLES

**SCHWERLASTROLLEN FÜR MASCHINEN**

GEHÄUSE AUS STAHL, VERSCHLEISSFEST, PROMAT-VERZ.  
BREITES SCHWENKLAGER AUS GEHÄRTETEM STAHL  
RAD MIT GLEITLAGER, ROLLENLAGER ODER KUGELLAGER

**RUOTE PER MACCHINE A CARICHI GRAVOSI**

SUPPORTI IN LAMIERA D'ACCIAIO, INALTERABILE, ZINCATO  
GRANDE PIROETTAMENTO SU PISTE D'ACCIAIO TEMPERATO  
RUOTA A FORO LISCIO, SU CUSCINETTO A RULLI E A SFERE

210 – 450 kg

**CAOUTCHOUC SUPER-ÉLASTIQUE**

Roue Caoutchouc Super-Elastique, noir, roue avec roulement à billes, silencieux, non-tachant, extra-souple, corps/roue: jante Alu

LE CAOUTCHOUC NOIR PEUT LAISSER DES TRACES AU SOL !!

**ELASTISCH-GUMMI**

Elastisches Vollgummirad, schwarz, Rad mit Kugellager, Laufruhe, spurfrei, extra-weich, Radkörper: Alu-Felge

SCHWARZGUMMI IST NICHT SPURFREI !!

**GOMMA-ELASTICA**

Ruota in Gomma Elastica, nero, ruota su cuscinetti a sfere, silenziosa, antitraccia, grande elasticità, corpo centrale: Alluminio

LA GOMMA NERA PUÒ SEGNARE IL SUOLO !!

Secteurs / Bereiche / Settori



MANUTENTION  
TRANSPORT  
TRASPORTO



TRANSPALETTE  
PALETTENWAGEN  
TRANSPALETTE

Applications / Anwendung / Applicazioni

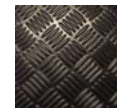

SOL ACIER  
STAHL  
ACCIAIO



PAVE  
PFLASTER-STEIN  
PAVIMENTO



GOUDRON  
ASPHALT  
ASFALTO

Variantes / Varianten / Varianti



-20° - +80° C  
70 Sh/A



ROUE  
PAGE 7.5  
200 – 495 kg



SERIE 5..-8..  
PAGE 5.6  
200 – 450 kg



SERIE 9..  
PAGE 6.1  
280 – 495 kg



SERIE TH/TW..  
PAGE 6.1  
500 – 850 kg

AVEC PLAQUE / MIT PLATTE / A PIASTRA

								ROUE PIVOTANTE LENKROLLE RUOTA GIREVOLE		PIVOTANT/FREIN LENKROLLE/BREMS GIREVOLE/FRENO		ROUE FIXE BOCKROLLE RUOTA FISSA						
								Prix Preis Prezzo		Prix Preis Prezzo		Prix Preis Prezzo						
								Art. N :	CHF sans TVA	Art. N :	CHF sans TVA	Art. N :	CHF sans TVA					
<b>ZINGUÉ_SERIE N° 55 'MEDIA+' (page 1.9)</b>																		
100	40		210	105x85	75x55 85x65	9	138	42	55153.10	61.80	55253.10	69.90	55353.10	50.80	-			
125	50		300	105x85	75x55 85x65	9	164	42	55153.12	66.80	55253.12	74.00	55353.12	55.80	-			
<b>ZINGUÉ_SERIE N° 66 'FORT+' (page 1.10)</b>																		
160	50		370	135x110	105x 75/80	12	198	55	66153.16	99.80	66253.16	119.10	66353.16	76.00	-			
200	50		450	135x110	105x 75/80	12	245	55	66153.20	109.90	66253.20	130.50	66353.20	88.30	-			

350 – 500 kg

**POLYAMIDE / NYLON 6**

Roue Polyamide/Nylon 6, gris, roue avec roulement à rouleaux ou à billes, non-tachant, corps/roue: Nylon 6 renforcé de fibres de verre

RÉSISTANT AUX HUILES/GRAISSES/ESSENCES...

**POLYAMID / NYLON 6**

Polamid-Rad/Nylon 6, grau, Rad mit Rollenlager oder Kugellager, spurfrei, Radkörper: Nylon 6 und Glasfaser verbinding

BESTÄNDIGKEIT GEGEN OEL/FETT/BENZIN...

**POLIAMMIDE / NYLON 6**

Ruota in Poliammide/Nylon 6, grigia, ruota su cuscinetti a rulli e a sfere, antitraccia, corpo centrale: Nylon 6 rinforzato con fibra di vetro

RESISTENDO AGLI OLI/GRASSI/PETROLI...

Secteurs / Bereiche / Settori



HUILE/ESSENCE  
OEL/BENZIN  
OLIPETROLI



USINE  
FABRIK  
INDUSTRIA

Applications / Anwendung / Applicazioni



INDUSTRIE  
INDUSTRIE  
INDUSTRIA



BETON  
BETON  
CEMENTO



TAPIS  
TEPPICH  
MOQUETTE

Variantes / Varianten / Varianti



-30° - +80° C  
NYLON



ROUE  
PAGE 7.14  
300 – 2500 kg



SERIE 5..-8..  
PAGE 5.17-19  
130 – 480 kg



SERIE 9..-TH..  
PAGE 6.9-10  
700 – 2700 kg

AVEC PLAQUE / MIT PLATTE / A PIASTRA

								ROUE PIVOTANTE LENKROLLE RUOTA GIREVOLE		PIVOTANT/FREIN LENKROLLE/BREMS GIREVOLE/FRENO		ROUE FIXE BOCKROLLE RUOTA FISSA					
								Prix Preis Prezzo		Prix Preis Prezzo		Prix Preis Prezzo					
								Art. N :	CHF sans TVA	Art. N :	CHF sans TVA	Art. N :	CHF sans TVA				
<b>ZINGUÉ_SERIE N° 55 'MEDIA+' (page 1.9)</b>																	
A)	76	46		350	105x85	75x55 85x65	9	116	42	55162.071	54.40	55262.071	65.10	55362.071	42.20	-	
B)	100	40		350	105x85	75x55 85x65	9	138	42	55162.101	51.30	55262.101	60.60	55362.101	40.30	-	
B)	125	30		350	105x85	75x55 85x65	9	164	42	55162.12	55.80	55262.12	65.50	55362.12	43.80	-	
	125	46		350	105x85	75x55 85x65	9	164	42	55166.12	63.20	55266.12	72.70	55366.12	50.80	-	
<b>ZINGUÉ_SERIE N° 66 'FORT+' (page 1.10)</b>																	
	160	46		500	135x110	105x 75/80	12	198	55	66166.16	94.10	66266.16	112.10	66366.16	72.00	-	
	200	50		500	135x110	105x 75/80	12	245	55	66166.20	104.90	66266.20	124.40	66366.20	84.80	-	

A) NYLON NOIR / NYLON SCHWARZ / NYLON NERO

B) NYLON BLANC / NYLON WEISS / NYLON BIANCO

**ROULETTES POUR MACHINES A CHARGES ELEVEES**

SUPPORT EN ACIER, INDEFORMABLE, PROMAT-ZINGUE  
LARGE PALIER DE PIVOTEMENT EN ACIER TREMPÉ RENFORCÉ  
ROUE A PALIER LISSE, ROULEMENT A ROULEAUX OU A BILLES

**SCHWERLASTROLLEN FÜR MASCHINEN**

GEHÄUSE AUS STAHL, VERSCHLEISSFEST, PROMAT-VERZ  
BREITES SCHWENKLAGER AUS GEHÄRTETEM STAHL  
RAD MIT GLEITLAGER, ROLLENLAGER ODER KUGELLAGER

**RUOTE PER MACCHINE A CARICHI GRAVOSI**

SUPPORTI IN LAMIERA D'ACCIAIO, INALTERABILE, ZINCATO  
GRANDE PIROETTAMENTO SU PISTE D'ACCIAIO TEMPERATO  
RUOTA A FORO LISCIO, SU CUSCINETTO A RULLI E A SFERE

350 – 490 kg

**POLYURÉTHANE**

Roue Polyuréthane injecté, gris, roue avec roulement à billes, non-tachant, silencieux  
corps/roue: Nylon 6 renforcé de fibres de verre, résistant aux huiles/grasses/essences...

RECOMMANDÉ POUR LES INDUSTRIES ET LES AGENCEMENTS

**POLYURETHAN**

Rad mit Spritzguss-Polyurethan, grau, Rad mit Kugellager, spurfrei, Laufruhe  
beständig gegen Oel/Fett/Benzin..., Radkörper: Nylon und Glasfaser Verbindung

EMPFOHLEN FÜR INDUSTRIE UND DIE EINRICHTUNGEN

**POLIURETANO**

Ruota rivestimento in Poliuretano iniettato, grigia, ruota su cuscinetti a sfere, antitraccia,  
silenziosa, resistendo agli oli/grassi/petroli..., corpo centrale: Nylon rinforzato con fibra di vetro

RACCOMANDATÒ PER INDUSTRIA E PER ARREDAMENTO

Secteurs / Bereiche / Settori



HUILE/ESSENCE  
OEL/BENZIN  
OLI/PETROLI



USINE  
FABRIK  
INDUSTRIA

Applications / Anwendung / Applicazioni



INDUSTRIE  
INDUSTRIE  
INDUSTRIA

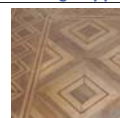

PARQUET BOIS  
HOLZ-PARKETT  
PARQUET



TAPIS  
TEPPICH  
MOQUETTE

Variantes / Varianten / Varianti



-25° - +80° C  
85 Sh/A



ROUE  
PAGE 7.7  
60 – 490 kg



SERIE 2...-3...  
PAGE 3.5  
60 – 120 kg



SERIE 5...-8...  
PAGE 5.11-12  
120 – 480 kg



SERIE 9...-TH...  
PAGE 6.3  
390 – 950 kg

AVEC PLAQUE / MIT PLATTE / A PIASTRA

								ROUE PIVOTANTE LENKROLLE RUOTA GIREVOLE		PIVOTANT/FREIN LENKROLLE/BREMS GIREVOLE/FRENO		ROUE FIXE BOCKROLLE RUOTA FISSA					
									Prix Preis Prezzo		Prix Preis Prezzo		Prix Preis Prezzo				
mm	mm	Page 1.6	kg	mm	mm	mm	mm	Art. N :	CHF sans TVA	Art. N :	CHF sans TVA	Art. N :	CHF sans TVA				
<b>ZINGUÉ SERIE N° 55 'MEDIA+' (page 1.9)</b>																	
A) 125	46		350	105x85	75x55 85x65	9	164	55176.12	66.10	55276.12	75.30	55376.12	53.90	-			
<b>ZINGUÉ SERIE N° 66 'FORT+' (page 1.10)</b>																	
A) 160	46		460	135x110	105x 75/80	12	198	66176.16	96.30	66276.16	114.10	66376.16	74.50	-			
A) 200	50		490	135x110	105x 75/80	12	245	66176.20	105.50	66276.20	124.80	66376.20	85.10	-			

A) EGLEMENT AVEC ROUE ANTISTATIQUE / AUCH MIT ANTISTATISCH-RÄDER / ANCHE CON RUOTA ANTISTATICO

300 – 500 kg

**POLYURÉTHANE**

Roue Polyuréthane ADIPRENE, rouge/brun, roue avec roulement à billes,  
non-tachant, silencieux, corps/roue: Fonte

RÉSISTANT AUX HUILES/GRAISSES/ESSENCES...

**POLYURETHAN**

Polyurethanrad ADIPREN, rot/braun, Rad mit Kugellager,  
spurfrei, Laufruhe, Radkörper: Guss

BESTÄNDIGKEIT GEGEN OEL/FETT/BENZIN...

**POLIURETANO**

Ruota in Poliuretano ADIPRENE, rosso/marrone, ruota su cuscinetti a sfere,  
antitraccia, silenziosa, corpo centrale: Ghisa

RESISTENDO AGLI OLI/GRASSI/PETROLI...

Secteurs / Bereiche / Settori



HUILE/ESSENCE  
OEL/BENZIN  
OLI/PETROLI



USINE  
FABRIK  
INDUSTRIA

Applications / Anwendung / Applicazioni



INDUSTRIE  
INDUSTRIE  
INDUSTRIA



BETON  
BETON  
CEMENTO



GOUDRON  
ASPHALT  
ASFALTO

Variantes / Varianten / Varianti



-35° - +70° C  
92 Sh/A



ROUE  
PAGE 7.10  
300 – 4500 kg



SERIE 9...  
PAGE 6.6  
480 – 1500 kg



SERIE TH...  
PAGE 6.6  
1400 – 2400 kg

AVEC PLAQUE / MIT PLATTE / A PIASTRA

								ROUE PIVOTANTE LENKROLLE RUOTA GIREVOLE		PIVOTANT/FREIN LENKROLLE/BREMS GIREVOLE/FRENO		ROUE FIXE BOCKROLLE RUOTA FISSA					
									Prix Preis Prezzo		Prix Preis Prezzo		Prix Preis Prezzo				
mm	mm	Page 1.6	kg	mm	mm	mm	mm	Art. N :	CHF sans TVA	Art. N :	CHF sans TVA	Art. N :	CHF sans TVA				
<b>ZINGUÉ SERIE N° 55 'MEDIA+' (page 1.9)</b>																	
80	30		300	105x85	75x55 85x65	9	120	55193.08	63.50	55293.08	74.50	55393.08	51.30	-			
100	30		300	105x85	75x55 85x65	9	138	55193.10	58.40	55293.10	68.70	55393.10	47.40	-			
100	40		350	105x85	75x55 85x65	9	138	55193.101	71.50	55293.101	82.20	55393.101	60.90	-			
125	50		350	105x85	75x55 85x65	9	164	55193.121	105.50	55293.121	117.30	55393.121	94.10	-			
<b>ZINGUÉ SERIE N° 66 'FORT+' (page 1.10)</b>																	
150	50		500	135x110	105x 75/80	12	198	66193.15	151.00	66293.15	169.90	66393.15	128.00	-			
200	50		500	135x110	105x 75/80	12	245	66193.20	141.00	66293.20	162.30	66393.20	120.80	-			

**RABAIS / RABATT / SCONTO : 20% dès/ab/da 100.-- (CHF) / 25% dès/ab/da 500.-- (CHF)**  
RABAIS DE QUANTITE SUR DEMANDE ! MENGENRABATT AUF ANFRAGE ! SCONTO DI QUANTITA SU RICHIESTA !



**ROULETTES POUR MACHINES A CHARGES ELEVEES**

SUPPORT EN ACIER, INDEFORMABLE, PROMAT-ZINGUE  
LARGE PALIER DE PIVOTEMENT EN ACIER TREMPÉ RENFORCÉ  
ROUE A PALIER LISSE, ROULEMENT A ROULEAUX OU A BILLES

**SCHWERLASTROLLEN FÜR MASCHINEN**

GEHÄUSE AUS STAHL, VERSCHLEISSFEST, PROMAT-VERZ.  
BREITES SCHWENKLAGER AUS GEHÄRTETEM STAHL  
RAD MIT GLEITLAGER, ROLLENLAGER ODER KUGELLAGER

**RUOTE PER MACCHINE A CARICHI GRAVOSI**

SUPPORTI IN LAMIERA D'ACCIAIO, INALTERABILE, ZINCATO  
GRANDE PIROETTAMENTO SU PISTE D'ACCIAIO TEMPERATO  
RUOTA A FORO LISCIO, SU CUSCINETTO A RULLI E A SFERE

210 – 290 kg

**POLYURÉTHANE**

Roue Polyuréthane injecté, rouge/brun, roue à palier lisse ou avec roulement à rouleaux, non-tachant, corps/roue: Nylon 6

RÉSISTANT AUX HUILES/GRAISSES/ESSENCES...

**POLYURETHAN**

Rad mit Spritzguss-Polyurethan, rot/braun, Rad mit Gleitlager oder Rollenlager, spurfrei, Radkörper: Nylon 6

BESTÄNDIGKEIT GEGEN OEL/FETT/BENZIN...

**POLIURETANO**

Ruota rivestimento in Poliuretano iniettato, rosso/marrone, ruota a foro liscio e su cuscinetti a rulli, antitraccia, corpo centrale: Nylon 6

RESISTENDO AGLI OLI/GRASSI/PETROLI...

Secteurs / Bereiche / Settori



HUILE/ESSENCE  
OEL/BENZIN  
OLIPETROLI



USINE  
FABRIK  
INDUSTRIA

Applications / Anwendung / Applicazioni



GOUDRON  
ASPHALT  
ASFALTO



INDUSTRIE  
INDUSTRIE  
INDUSTRIA



BETON  
BETON  
CEMENTO

Variantes / Varianten / Varianti



-25° - +80° C  
94 Sh/A



ROUE  
PAGE 7.9  
80 – 290 kg



SERIE 2..-3..  
PAGE 3.4  
50 – 120 kg



SERIE TL..  
PAGE 4.3  
180 – 270 kg



SERIE 5..-7..  
PAGE 5.15  
120 - 280 kg

AVEC PLAQUE / MIT PLATTE / A PIASTRA

										ROUE PIVOTANTE LENKROLLE RUOTA GIREVOLE		PIVOTANT/FREIN LENKROLLE/BREMS GIREVOLE/FRENO		ROUE FIXE BOCKROLLE RUOTA FISSA							
										Prix Preis Prezzo		Prix Preis Prezzo		Prix Preis Prezzo							
										Art. N :	CHF sans TVA	Art. N :	CHF sans TVA	Art. N :	CHF sans TVA						
<b>ZINGUÉ_SERIE N° 55 'MEDIA+' (page 1.9)</b>																					
80	30		210	105x85	75x55 85x65	9	120	42		55172.08	52.90	55272.08	56.80	55372.08	37.60	-					
100	30		270	105x85	75x55 85x65	9	138	42		55172.10	45.80	55272.10	53.80	55372.10	35.10	-					
125	30		290	105x85	75x55 85x65	9	164	42		55172.12	50.50	55272.12	58.70	55372.12	38.90	-					

350 – 500 kg

**POLYURÉTHANE**

Roue Polyuréthane injecté, rouge/brun, roue avec roulement à billes, non-tachant, corps/roue: Nylon 6 renforcé de fibres de verre

RÉSISTANT AUX HUILES/GRAISSES/ESSENCES...

**POLYURETHAN**

Rad mit Spritzguss-Polyurethan, rot/braun, Rad mit Kugellager, spurfrei, Radkörper: Nylon 6 und Glasfaser verbindung

BESTÄNDIGKEIT GEGEN OEL/FETT/BENZIN...

**POLIURETANO**

Ruota rivestimento in Poliuretano iniettato, rosso/marrone, ruota su cuscinetti a sfere, antitraccia, corpo centrale: Nylon 6 rinforzato con fibra di vetro

RESISTENDO AGLI OLI/GRASSI/PETROLI...

Secteurs / Bereiche / Settori



HUILE/ESSENCE  
OEL/BENZIN  
OLIPETROLI



USINE  
FABRIK  
INDUSTRIA

Applications / Anwendung / Applicazioni



GOUDRON  
ASPHALT  
ASFALTO



INDUSTRIE  
INDUSTRIE  
INDUSTRIA



BETON  
BETON  
CEMENTO

Variantes / Varianten / Varianti



-25° - +80° C  
94 Sh/A



ROUE  
PAGE 7.9  
550 – 850 kg



SERIE 5..-8..  
PAGE 5.16  
350 – 480 kg



SERIE 9..  
PAGE 6.5  
550 – 850 kg



SERIE TH..  
PAGE 6.5  
1100 - 1600 kg

AVEC PLAQUE / MIT PLATTE / A PIASTRA

										ROUE PIVOTANTE LENKROLLE RUOTA GIREVOLE		PIVOTANT/FREIN LENKROLLE/BREMS GIREVOLE/FRENO		ROUE FIXE BOCKROLLE RUOTA FISSA							
										Prix Preis Prezzo		Prix Preis Prezzo		Prix Preis Prezzo							
										Art. N :	CHF sans TVA	Art. N :	CHF sans TVA	Art. N :	CHF sans TVA						
<b>ZINGUÉ_SERIE N° 55 'MEDIA+' (page 1.9)</b>																					
125	46		350	105x85	75x55 85x65	9	164	42		551776.12	67.60	552776.12	76.90	553776.12	55.40	-					
<b>ZINGUÉ_SERIE N° 66 'FORT+' (page 1.10)</b>																					
160	46		500	135x110	105x 75/80	12	198	55		661776.16	100.50	662776.16	119.20	663776.16	77.10	-					
200	50		500	135x110	105x 75/80	12	245	55		661776.20	111.40	662776.20	131.70	663776.20	89.60	-					

**ROULETTES POUR MACHINES A CHARGES ELEVEES**

SUPPORT EN ACIER, INDEFORMABLE, PROMAT-ZINGUE  
LARGE PALIER DE PIVOTEMENT EN ACIER TREMPÉ RENFORCÉ  
ROUE A PALIER LISSE, ROULEMENT A ROULEAUX OU A BILLES

**SCHWERLASTROLLEN FÜR MASCHINEN**

GEHÄUSE AUS STAHL, VERSCHLEISSFEST, PROMAT-VERZ  
BREITES SCHWENKLAGER AUS GEHÄRTETEM STAHL  
RAD MIT GLEITLAGER, ROLLENLAGER ODER KUGELLAGER

**RUOTE PER MACCHINE A CARICHI GRAVOSI**

SUPPORTI IN LAMIERA D'ACCIAIO, INALTERABILE, ZINCATO  
GRANDE PIROETTAMENTO SU PISTE D'ACCIAIO TEMPERATO  
RUOTA A FORO LISCIO, SU CUSCINETTO A RULLI E A SFERE

230 – 320 kg

**FONTE**

Roue en Fonte pleine, gris, roue à palier lisse ou avec roulement à rouleaux, surface de roulement bombée, corps/roue: Fonte

RÉSISTANT AUX HUILES/GRAISSES/ESSENCES...

**GUSS**

Guss-Rad, Vollscheibe, grau, Rad mit Gleitlager oder Rollenlager  
gewölbte Lauffläche, Radkörper: Guss

BESTÄNDIGKEIT GEGEN OEL/FETT/BENZIN...

**GHISA**

Ruota in Ghisa, piena, grigia, ruota a foro liscio o su cuscinetti a rulli  
superficie di rotolamento convessa, corpo centrale: Ghisa

RESISTENDO AGLI OLI/GRASSI/PETROLI...

Secteurs / Bereiche / Settori



HUILE/ESSENCE  
OEL/BENZIN  
OLI/PETROLI

Applications / Anwendung / Applicazioni



USINE  
FABRIK  
INDUSTRIA



CHALEUR  
HITZEBESTANDIG  
ALTE TEMPERAT.

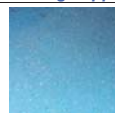

INDUSTRIE  
INDUSTRIE  
INDUSTRIA



BETON  
BETON  
CEMENTO

Variantes / Varianten / Varianti



-40° - +340° C  
FONTE



ROUE  
PAGE 7.12  
290 – 2500 kg



SERIE TH..  
PAGE 6.11  
900 – 2200 kg



SERIE TH/TW..  
PAGE 6.11  
1800 – 2700 kg

AVEC PLAQUE / MIT PLATTE / A PIASTRA

										ROUE PIVOTANTE LENKROLLE RUOTA GIREVOLE	PIVOTANT/FREIN LENKROLLE/BREMS GIREVOLE/FRENO	ROUE FIXE BOCKROLLE RUOTA FISSA							
													Prix Preis Prezzo	Prix Preis Prezzo	Prix Preis Prezzo				
										Art. N :	Art. N :	Art. N :	CHF sans TVA	CHF sans TVA	CHF sans TVA				
<b>ZINGUÉ_SERIE N° 55 'MEDIA+' (page 1.9)</b>																			
<b>75</b>	30		<b>230</b>	105x85	75x55 85x65	9	120	42		<b>551-43 CI</b>	47.40	<b>552-43 CI</b>	59.00	<b>553-43 CI</b>	34.40				
<b>100</b>	38		<b>300</b>	105x85	75x55 85x65	9	138	42		<b>551-44 CIR</b>	62.70	<b>552-44 CIR</b>	73.50	<b>553-44 CIR</b>	49.30				
<b>125</b>	38		<b>320</b>	105x85	75x55 85x65	9	164	42		<b>551-45 CIR</b>	70.60	<b>552-45 CIR</b>	82.50	<b>553-45 CIR</b>	57.60				

180 – 320 kg

**FONTE / POLYURÉTHANE / NYLON**

**"TORTUE"**

Roue en Fonte pleine, en Polyuréthane ou en Nylon, roue à palier lisse, corps/roue: Fonte ou en Nylon 6

RÉSISTANT AUX HUILES/GRAISSES/ESSENCES...

**GUSS / POLYURETHAN / NYLON**

**"SCHILDKRÖTE"**

Rad aus Guss, Polyurethan oder Nylon, Rad mit Gleitlager, Radkörper: Guss oder aus Nylon 6

BESTÄNDIGKEIT GEGEN OEL/FETT/BENZIN...

**GHISA / POLIURETANO / NYLON**

**"TARTARUGA"**

Ruota in Ghisa, in Polyurethan o in Nylon, ruota a foro liscio, corpo centrale: Ghisa e Nylon 6

RESISTENDO AGLI OLI/GRASSI/PETROLI...

Secteurs / Bereiche / Settori



HUILE/ESSENCE  
OEL/BENZIN  
OLI/PETROLI



USINE  
FABRIK  
INDUSTRIA

Applications / Anwendung / Applicazioni



PARQUET BOIS  
HOLZ-PARKETT  
PARQUET



INDUSTRIE  
INDUSTRIE  
INDUSTRIA



BETON  
BETON  
CEMENTO

AVEC PLAQUE / MIT PLATTE / A PIASTRA

										ROUE PIVOTANTE LENKROLLE RUOTA GIREVOLE	ROUE PIVOTANTE LENKROLLE RUOTA GIREVOLE	ROUE PIVOTANTE LENKROLLE RUOTA GIREVOLE							
													Prix Preis Prezzo	Prix Preis Prezzo	Prix Preis Prezzo				
										Art. N :	Art. N :	Art. N :	CHF sans TVA	CHF sans TVA	CHF sans TVA				
<b>ZINGUÉ_SERIE N° 2052 'FORT'</b>																			
<b>50</b>	2x18		<b>180</b>	95	36x36	7	64	25		<b>2052 NY.05</b>	55.00	---		---					
<b>50</b>	2x14		<b>250</b>	95	36x36	7	64	25		---		<b>2052 PT.05</b>	90.20	---					
<b>50</b>	2x14		<b>320</b>	95	36x36	7	64	25		---		---		<b>2052 CI.05</b>	72.00				

**RABAIS / RABATT / SCONTO : 20% dès/ab/da 100.-- (CHF) / 25% dès/ab/da 500.-- (CHF)**  
RABAIS DE QUANTITE SUR DEMANDE ! MENGENRABATT AUF ANFRAGE ! SCONTO DI QUANTITA SU RICHIESTA !

**ROULETTES POUR MACHINES A CHARGES ELEVEES**

SUPPORT EN ACIER, INDEFORMABLE, PROMAT-ZINGUE  
LARGE PALIER DE PIVOTEMENT EN ACIER TREMPÉ RENFORCÉ  
ROUE A PALIER LISSE, ROULEMENT A ROULEAUX OU A BILLES

**SCHWERLASTROLLEN FÜR MASCHINEN**

GEHÄUSE AUS STAHL, VERSCHLEISSFEST, PROMAT-VERZ.  
BREITES SCHWENKLAGER AUS GEHÄRTETEM STAHL  
RAD MIT GLEITLAGER, ROLLENLAGER ODER KUGELLAGER

**RUOTE PER MACCHINE A CARICHI GRAVOSI**

SUPPORTI IN LAMIERA D'ACCIAIO, INALTERABILE, ZINCATO  
GRANDE PIROETTAMENTO SU PISTE D'ACCIAIO TEMPERATO  
RUOTA A FORO LISCIO, SU CUSCINETTO A RULLI E A SFERE

100 – 2000 kg



**VÉRIN OU PIED DE POSITION**

Verin fixe ou orientable avec tige à visser, corps: Nylon 6, noir

**STELLFÜSSE ODER GELENKFÜSSE**

Stellfüsse befestigt oder verstellbar mit Gewindespindeln, Körper: Nylon 6, schwarz

**MARTINETTO O PIEDE DE POSIZIONE**

Martinetto fissa o orientabile anche, corpo: Nylon 6, nero

					FIXE BEFESTIGT FISSA		TOURNABLE DREHBAR GIREVOLE							ORIENTABLE VERSTELLBAR ORIENTABILE		ORIENTABLE VERSTELLBAR ORIENTABILE			
mm	mm	kg	mm	mm	Art. N :	Prix Preis Prezzo CHF sans TVA	Art. N :	Prix Preis Prezzo CHF sans TVA	mm	mm	kg	mm	mm	°	mm	Art. N :	Prix Preis Prezzo CHF sans TVA	Art. N :	Prix Preis Prezzo CHF sans TVA
40	10	250	M8	25-40	4001-40-M8	4.10	---	---	47	20	100	M8	25-100	20°	---	4020-47-M8	6.70	---	---
40	10	250	M10	25-40	4001-40-M10	4.60	---	---	47	20	250	M10	25-100	20°	---	4020-47-M10	8.70	---	---
25	15	500	M8	25-70	---	---	4010-25-M8	6.30	47	20	250	M12	25-100	20°	---	4020-47-M12	10.20	---	---
25	15	500	M10	25-100	---	---	4010-25-M10	7.60	100	36	750	M10	25-100	20°	11	---	---	4030-100-M10	14.40
37	15	750	M10	25-100	---	---	4010-37-M10	8.30	100	36	750	M12	25-100	20°	11	---	---	4030-100-M12	15.80
47	15	500	M8	25-70	---	---	4010-47-M8	8.30	100	36	1000	M16	25-100	20°	11	---	---	4030-100-M16	17.20
47	15	750	M10	25-100	---	---	4010-47-M10	10.30											
47	15	1000	M12	25-100	---	---	4010-47-M12	11.90											
80	15	750	M10	25-100	---	---	4010-80-M10	11.80											

A) AVEC GOMME AMORTISSEUR +CHF 3.50 / MIT SCHWINGUNGSDÄMPFUNG (GUMMI) +CHF 3.50 / CON GOMMA SILENCIO +CHF 3.50

>> PAGE / SEITE / PAGINA >2.9 + 3.13 + 4.7 + 5.21

**RABAIS SPÉCIAL 25%**

SET-TRANSPALETTE (4 pces, au choix)

**SPEZIAL-RABATT 25%**

SET-PALETTTHUBWAGEN (4 Stk, nach wahl)

**SCONTO SPECIALE 25%**

SET-TRANSPALLETTE (4 pz, a scelta)

ACTION



**ROUES POUR TRANSPALETTE**

**RÄDER FÜR PALETTTHUBWAGEN**

**RUOTE PER TRANSPALLETTE**



					ROUE RÄDER RUOTA		ROUE RÄDER RUOTA							ROUE RÄDER RUOTA		ROUE RÄDER RUOTA			
mm	mm	Page 1.6	kg	mm	mm	Art. N :	Prix Preis Prezzo CHF sans TVA	Art. N :	Prix Preis Prezzo CHF sans TVA	mm	mm	Page 1.6	kg	mm	mm	Art. N :	Prix Preis Prezzo CHF sans TVA	Art. N :	Prix Preis Prezzo CHF sans TVA
200	50					CAOUTCHOUC	53.20 / 69.00	CAOUTCHOUC	33.20 / 70.30	85	70					NYLON	32.80	POLYURETHAN	60.90
																RNY 87		RPO 87	

AUTRES GRANDEURS DISPONIBLES, page 7.1-15 / ANDERE VERFÜGBAREN GRÖßEN, Seite 7.1-15 / ALTRE DIMENSIONI DISPONIBILI, pagina 7.1-15







# ROULETTES POUR TRANSPORTS

## TRANSPORT-ROLLEN

## RUOTE PER TRASPORTO

# 5



50 – 460 kg



80 - 280 mm

INDEX / INHALT / INDICE



**PAGE 5.1-2**  
CAOUTCH-TER  
GUMMI-THERMO  
GOMMA-TERMO



**PAGE 5.3**  
CAOUTCHOU  
GUMMI  
GOMMA



**PAGE 5.4**  
CAOUTCHOU  
GUMMI  
GOMMA



**PAGE 5.5**  
CAOUTCHOU  
GUMMI  
GOMMA

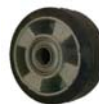

**PAGE 5.6**  
CAOUTCH-ELAST  
GUMMI-ELAST  
GOMMA-ELAST



**PAGE 5.7-8**  
CAOUTCH-ELAST  
GUMMI-ELAST  
GOMMA-ELAST



**PAGE 5.9**  
PNEU-SOFT  
SOFT-REIFEN  
PNEU-SOFT



**PAGE 5.10**  
PNEUMATIQUE  
LUFT-REIFEN  
PNEUMATISCHE



**PAGE 5.11-12**  
POLYURETHANE  
POLYURETHAN  
POLIURETANO



**PAGE 5.13-14**  
ANTISTATISQUE  
ANTISTATISCH  
ANTISTATICO



**PAGE 5.15**  
POLYURETHANE  
POLYURETHAN  
POLIURETANO



**PAGE 5.16**  
POLYURETHANE  
POLYURETHAN  
POLIURETANO



**PAGE 5.17-18**  
POLYAMIDE  
POLYAMID  
POLIAMMIDE



**PAGE 5.19**  
NYLON 6  
NYLON 6  
NYLON 6



**PAGE 5.20**  
ROUE CHALEUR  
HITZBESTANDIG  
ALTE TEMPERAT.



**PAGE 5.21**  
ACTION - AKTION  
CONTAINER  
FLIGHT-CASES

SECTEURS / BEREICHE / SETTORI



**ROULETTES POUR TRANSPORTS ET INDUSTRIES**

SUPPORT EN ACIER, ZINGUÉ-PROMATISÉ  
PIVOTEMENT SUR DOUBLE RANGÉE DE BILLES  
ROUE À PALIER LISSE, ROULEMENT À ROULEAUX OU À BILLES

**TRANSPORT- UND INDUSTRIE-ROLLEN**

GEHÄUSE AUS STAHLBLECH, VERZINKT-PROMATISIERT  
SCHWENKLAGER MIT ZWEIFACHEM KUGELKRANZ  
RAD MIT GLEITLAGER, ROLLENLAGER ODER KUGELLAGER

**RUOTE PER TRASPORTO ED INDUSTRIE**

SUPPORTI IN LAMIERA D'ACCIAIO, ZINCATO-CROMATO  
PIROETTAMENTO A DOPPIA CORONA DI SFERE  
RUOTA A FORO LISCIO, SU CUSCINETTO A RULLI E A SFERE

90 – 120 kg

**CAOUTCHOUC/Thermoplastique**

Roue Caoutchouc Thermoplastique, gris, roue avec roulement à rouleaux ou à billes, non-tachant, silencieux, corps/roue: Nylon renforcé de fibres de verre

RECOMMANDÉ POUR LES CUISINES, LES HOPITAUX ET LES AGENCEMENTS

**GUMMI/Thermoplastisch**

Gummirad Thermoplastisch, grau, Rad mit Gleitlager oder Kugellager, spurfrei, Laufruhe, Radkörper: Nylon und Glasfaser Verbindung

EMPFOHLEN FÜR DIE KÜCHEN, DIE SPITÄLER UND DIE EINRICHTUNGEN

**GOMMA/Termoplastica**

Ruota in Gomma Termoplastica, grigia, ruota a foro liscio o su cuscinetti a sfere, antitraccia, silenziosa, corpo centrale: Nylon rinforzato con fibre di vetro

RACCOMANDATÒ PER LE CUCINE, OSPEDALI E PER ARREDAMENTO

Secteurs / Bereiche / Settori



HOPITAL  
SPITAL  
OSPEDALE

CUISINE  
KÜCHE  
CUCINA

Applications / Anwendung / Applicazioni



CARRELAGE  
FLIESEN  
PIASTRELLE

PARQUET BOIS  
HOLZ-PARKETT  
PARQUET

INDUSTRIE  
INDUSTRIE  
INDUSTRIA

Variantes / Varianten / Varianti



-20° - +80° C  
87 Sh/A



ROUE  
PAGE 7.1  
50 – 130 kg



SERIE 2..-3..  
PAGE 3.1-2  
50 – 120 kg



SERIE H..  
PAGE 3.11  
100 – 120 kg

AVEC PLAQUE / MIT PLATTE / A PIASTRA

AVEC TROU / MIT LOCH / A FORO

								ROUE PIVOTANTE LENKROLLE RUOTA GIREVOLE		PIVOTANT/FREIN LENKROLLE/BREMS GIREVOLE/FRENO		ROUE FIXE BOCKROLLE RUOTA FISSA				ROUE PIVOTANTE LENKROLLE RUOTA GIREVOLE		PIVOTANT/FREIN LENKROLLE/BREMS GIREVOLE/FRENO	
mm	mm	Page 1.6	kg	mm	mm	mm	mm	Art. N :	CHF sans TVA	Art. N :	CHF sans TVA	Art. N :	CHF sans TVA	mm	Art. N :	CHF sans TVA	Art. N :	CHF sans TVA	
<b>ZINGUE_SERIE N° 7 'LEGER' (page 1.9)</b>																			
A) 80	32		90	105x85	80x60	9	106	38	7111.08	19.90	7211.08	30.60	7311.08	17.80	12.3	7011.08	19.60	7711.08	30.20
A) 100	32		100	105x85	80x60	9	128	40	7111.10	23.00	7211.10	33.80	7311.10	21.20	12.3	7011.10	23.00	7711.10	33.30
<b>ZINGUE_SERIE N° 5 'MEDIA' (page 1.9)</b>																			
A) 80	32		100	105x85	75x55 85x65	9	108	38	5111.08	23.40	5211.08	33.50	5311.08	18.40	12.3	5011.08	22.50	5711.08	33.80
80	32		100	105x85	75x55 85x65	9	108	38	5113.08	27.30	5213.08	38.00	5313.08	23.00	12.3	5013.08	27.10	5713.08	37.70
A) 100	32		110	105x85	75x55 85x65	9	129	38	5111.10	26.10	5211.10	36.80	5311.10	22.10	12.3	5011.10	25.90	5711.10	36.40
100	32		110	105x85	75x55 85x65	9	129	38	5113.10	30.60	5213.10	41.20	5313.10	26.40	12.3	5013.10	30.20	5713.10	41.00
125	37		130	105x85	75x55 85x65	9	155	45	5112.12	27.60	5212.12	39.20	5312.12	23.70	12.3	5012.12	27.30	5712.12	38.90
125	32		120	105x85	75x55 85x65	9	155	45	5113.12	36.00	5213.12	48.00	5313.12	32.40	12.3	5013.12	36.00	5713.12	47.80
B) 125	32		120	105x85	75x55 85x65	9	155	45	5113.12-S	37.10	5213.12-S	49.20	5313.12-S	33.50	12.3	5013.12-S	37.10	5713.12-S	48.90
<b>INOX_SERIE N° 7 'LEGER' (page 1.9)</b>																			
<b>INOX / ROSTFREI / INOX</b>																			
A) 80	32		90	105x85	80x60	9	106	38	X-7111.08	41.20	X-7211.08	58.90	X-7311.08	35.20	12.3	X-7011.08	40.50	X-7711.08	58.60
A) 100	32		100	105x85	80x60	9	128	38	X-7111.10	45.20	X-7211.10	62.40	X-7311.10	38.30	12.3	X-7011.10	43.80	X-7711.10	62.00
<b>INOX_SERIE N° 5 'MEDIA' (page 1.9)</b>																			
<b>INOX / ROSTFREI / INOX (2RS)</b>																			
A) 80	32		100	105x85	75x55 85x65	9	108	38	X-5111.08	53.30	X-5211.08	77.20	X-5311.08	39.80	12.3	X-5011.08	50.60	X-5711.08	75.30
80	32		100	105x85	75x55 85x65	9	108	38	X-5113.08	57.80	X-5213.08	83.30	X-5313.08	44.40	12.3	X-5013.08	55.70	X-5713.08	80.80
A) 100	32		110	105x85	75x55 85x65	9	129	38	X-5111.10	57.20	X-5211.10	82.50	X-5311.10	44.50	12.3	X-5011.10	54.80	X-5711.10	80.40
100	32		110	105x85	75x55 85x65	9	129	38	X-5113.10	62.70	X-5213.10	89.00	X-5313.10	49.30	12.3	X-5013.10	60.10	X-5713.10	86.80
125	32		120	105x85	75x55 85x65	9	155	45	X-5113.12	71.80	X-5213.12	98.60	X-5313.12	60.70	12.3	X-5013.12	69.30	X-5713.12	96.30

A) ROUE SANS PARE-FILES / RAD OHNE FADENSCHUTZ / RUOTA SENZA PARAFILI  
B) AVEC CAOUTCHOUC-ELASTIQUE 75 Sh/A / MIT ELASTISCHE-GUMMI 75 Sh/A / CON GOMMA-ELASTIK 75 Sh/A  
C) ROULETTE FIXE, PLAQUE / BOCKROLLE, PLATTE / RUOTA FISSA, PIASTRA: 108x87mm – 75x55 / 85x65mm  
D) ROULETTE AVEC TROU, HAUTEUR -4mm / ROLLEN MIT LOCH, BAUHÖHE -4mm / RUOTA CON FORO, ALTEZZA -4mm



**ROULETTES POUR TRANSPORTS ET INDUSTRIES**

SUPPORT EN ACIER, ZINGUÉ-PROMATISÉ  
PIVOTEMENT SUR DOUBLE RANGÉE DE BILLES  
ROUE À PALIER LISSE, ROULEMENT À ROULEAUX OU À BILLES

**TRANSPORT- UND INDUSTRIE-ROLLEN**

GEHÄUSE AUS STAHLBLECH, VERZINKT-PROMATISIERT  
SCHWENKLAGER MIT ZWEIFACHEM KUGELKRANZ  
RAD MIT GLEITLAGER, ROLLENLAGER ODER KUGELLAGER

**RUOTE PER TRASPORTO ED INDUSTRIA**

SUPPORTI IN LAMIERA D'ACCIAIO, ZINCATO-CROMATO  
PIROETTAMENTO A DOPPIA CORONA DI SFERE  
RUOTA A FORO LISCIO, SU CUSCINETTO A RULLI E A SFERE

190 – 310 kg

**CAOUTCHOUC/Thermoplastique**

Roue Caoutchouc Thermoplastique, gris, roue avec roulement à rouleaux ou à billes, non-tachant, silencieux, corps/roue: Nylon renforcé de fibres de verre

RECOMMANDÉ POUR LES CUISINES, LES HOPITAUX ET LES AGENCEMENTS

**GUMMI/Thermoplastisch**

Gummirad Thermoplastisch, grau, Rad mit Gleitlager oder Kugellager, spurfrei, Laufruhe, Radkörper: Nylon und Glasfaser Verbindung

EMPFOLHEN FÜR DIE KÜCHEN, DIE SPITÄLER UND DIE EINRICHTUNGEN

**GOMMA/Termoplastica**

Ruota in Gomma Termoplastica, grigia, ruota a foro liscio o su cuscinetti a sfere, antiraccia, silenziosa, corpo centrale: Nylon rinforzato con fibre di vetro

RACCOMANDATÒ PER LE CUCINE, OSPEDALI E PER ARREDAMENTO

Secteurs / Bereiche / Settori



HOPITAL  
SPITAL  
OSPEDALE

CUISINE  
KÜCHE  
CUCINA

Applications / Anwendung / Applicazioni

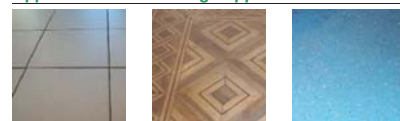

CARRELAGE  
FLIESEN  
PIASTRELLE

PARQUET BOIS  
HOLZ-PARKETT  
PARQUET

INDUSTRIE  
INDUSTRIE  
INDUSTRIA

Variantes / Varianten / Varianti



-20° - +80° C  
87 Sh/A



ROUE  
PAGE 7.1  
50 – 130 kg



SERIE 2..3..  
PAGE 3.1-2  
50 – 120 kg



SERIE H..  
PAGE 3.11  
100 – 120 kg

AVEC PLAQUE / MIT PLATTE / A PIASTRA

AVEC TROU / MIT LOCH / A FORO

								ROUE PIVOTANTE LENKROLLE RUOTA GIREVOLE		PIVOTANT/FREIN LENKROLLE/BREMS GIREVOLE/FRENO		ROUE FIXE BOCKROLLE RUOTA FISSA				ROUE PIVOTANTE LENKROLLE RUOTA GIREVOLE		PIVOTANT/FREIN LENKROLLE/BREMS GIREVOLE/FRENO		
								Art. N :		Art. N :		Art. N :		mm		Art. N :		Art. N :		
								CHF sans TVA		CHF sans TVA		CHF sans TVA				CHF sans TVA		CHF sans TVA		
<b>ZINGUE_SERIE N° 8 'MEDIA' (page 1.9)</b>																				
A)	160	46	210	135x110	105x80	11	195	52	8116.16	67.60	8216.16	82.10	8316.16	59.00	16.3	8016.16	68.50	8716.16	81.00	
A)	200	50	250	135x110	105x80	11	235	55	8116.20	80.80	8216.20	95.00	8316.20	72.50	16.3	8016.20	80.50	8716.20	95.20	
<b>ZINGUE_SERIE N° 6 'FORT' (page 1.10)</b>																				
	125	46	190	135x110	105x75-80	11	B) 164	53	6116.12	61.30	6216.12	78.60	6316.12	51.90	16.3	6016.12	60.10	6716.12	79.10	
	160	46	250	135x110	105x75-80	11	B) 199	55	6116.16	71.20	6216.16	88.70	6316.16	61.60	16.3	6016.16	71.50	6716.16	90.40	
	200	50	310	135x110	105x75-80	11	B) 237	58	6116.20	82.80	6216.20	102.70	6316.20	75.00	16.3	6016.20	84.80	6716.20	104.60	
<b>INOX_SERIE N° 8 'MEDIA' (page 1.9)</b>								<b>INOX / ROSTFREI / INOX (2RS)</b>				<b>INOX / ROSTFREI / INOX (2RS)</b>								
A)	160	46	210	135x110	105x80	11	195	52	X-8116.16	118.60	X-8216.16	149.30	X-8316.16	116.50	16.3	X-8016.16	118.20	X-8716.16	148.30	
A)	200	50	270	135x110	105x80	11	235	55	X-8116.20	138.90	X-8216.20	169.10	X-8316.20	132.30	16.3	X-8016.20	139.30	X-8716.20	168.10	
<b>INOX_SERIE N° 6 'FORT' (page 1.10)</b>								<b>INOX / ROSTFREI / INOX (2RS)</b>				<b>INOX / ROSTFREI / INOX (2RS)</b>								
A)	125	46	190	135x110	105x75-80	11	B) 164	53	X-6116.12	132.30	X-6216.12	182.70	X-6316.12	108.90	16.3	X-6016.12	130.30	X-6716.12	181.90	
A)	160	46	250	135x110	105x75-80	11	B) 199	55	X-6116.16	143.40	X-6216.16	194.00	X-6316.16	119.10	16.3	X-6016.16	142.60	X-6716.16	193.20	
A)	200	50	310	135x110	105x75-80	11	B) 237	58	X-6116.20	156.90	X-6216.20	213.70	X-6316.20	137.40	16.3	X-6016.20	157.80	X-6716.20	212.90	

A) EGALEMENT AVEC ROULEMENT A BILLES EN INOX +CHF 16.00 / AUCH MIT KUGELLAGER AUS ROSTFREI +CHF 16.00 / ANCHE CON CUSCINETTO A SFERE IN INOX +CHF 16.00  
B) ROULETTE AVEC TROU, HAUTEUR -6mm / ROLLEN MIT LOCH, BAUHÖHE -6mm / RUOTA CON FORO, ALTEZZA -6mm

AVEC BLOCAGE DE DIRECTION  
MIT RICHTUNGSFESTSTELLER  
CON FRENO DIREZIONALE

ROULETTE FIXE AVEC FREIN  
BOCKROLLE MIT FESTSTELLER  
RUOTA FISSA CON FRENO



**RABAIS / RABATT / SCONTO : 20% dès/ab/da 100.-- (CHF) / 25% dès/ab/da 500.-- (CHF)**  
RABAIS DE QUANTITE SUR DEMANDE ! MENGENRABATT AUF ANFRAGE ! SCONTO DI QUANTITA SU RICHIESTA !



SUPPORT EN ACIER, ZINGUÉ-PROMATISIÉ  
PIVOTEMENT SUR DOUBLE RANGÉE DE BILLES  
ROUE À PALIER LISSE, ROULEMENT À ROULEAUX OU À BILLES

GEHÄUSE AUS STAHLBLECH, VERZINKT-PROMATISIERT  
SCHWENKLAGER MIT ZWEIFACHEM KUGELKRANZ  
RAD MIT GLEITLAGER, ROLLENLAGER ODER KUGELLAGER

SUPPORTI IN LAMIERA D'ACCIAIO, ZINCATO-CROMATO  
PIROETTAMENTO A DOPPIA CORONA DI SFERE  
RUOTA A FORO LISCIO, SU CUSCINETTO A RULLI E A SFERE

**50 – 200 kg**

**CAOUTCHOUC**

Roue Caoutchouc Plein, gris, roue à palier lisse ou avec roulement à rouleaux, non-tachant, silencieux, corps/roue: Polyamide

**GRIS - NON-TACHANT**

**GUMMI**

Vollgummirad, grau, Rad mit Gleitlager oder Rollenlager, spurfrei, Laufruhe, Radkörper: Polyamid

**GRAU - SPURFREI**

**GOMMA**

Ruota in Gomma, grigia, ruota a foro liscio o su cuscinetti a rulli, antitraccia, silencia, corpo centrale: Poliammide

**GRIGIA - ANTITRACCIA**

Secteurs / Bereiche / Settori



HOPITAL  
SPITAL  
OSPEDALE



MAGASIN  
BETRIEB  
COMMERCIO

Applications / Anwendung / Applicazioni



CARRELAGE  
FLIESEN  
PIASTRELLE



PARQUET BOIS  
HOLZ-PARKETT  
PARQUET



LINO  
LINOLEUM

Variantes / Varianten / Varianti



-10° - +65° C  
85 Sh/A



ROUE  
PAGE 7.2  
50 – 200 kg



SERIE 2..3..  
PAGE 3.3  
50 – 90 kg

AVEC PLAQUE / MIT PLATTE / A PIASTRA

AVEC TROU / MIT LOCH / A FORO

										ROUE PIVOTANTE LENKROLLE RUOTA GIREVOLE		PIVOTANT/FREIN LENKROLLE/BREMS GIREVOLE/FRENO		ROUE FIXE BOCKROLLE RUOTA FISSA												ROUE PIVOTANTE LENKROLLE RUOTA GIREVOLE		PIVOTANT/FREIN LENKROLLE/BREMS GIREVOLE/FRENO	
mm	mm	Page	kg	mm	mm	mm	mm	mm	mm	Art. N :	CHF sans TVA	Art. N :	CHF sans TVA	Art. N :	CHF sans TVA	mm	Art. N :	CHF sans TVA	Art. N :	CHF sans TVA									
<b>ZINGUE_SERIE N° 7 'LEGER' (page 1.9)</b>																													
80	25	50	105x85	80x60	9	106	38			7121.08-G	16.00	7221.08-G	25.90	7321.08-G	14.30	12.3	7021.08-G	16.00	7721.08-G	25.50									
100	30	75	105x85	80x60	9	128	40			7121.10-G	19.00	7221.10-G	28.70	7321.10-G	17.20	12.3	7021.10-G	19.00	7721.10-G	28.30									
<b>ZINGUE_SERIE N° 5 'MEDIA' (page 1.9)</b>																													
125	38	110	A) 105x85 75x55 85x65	B) 155	9	155	45			5121.12-G	25.20	5221.12-G	37.10	5321.12-G	21.40	12.3	5021.12-G	25.00	5721.12-G	36.80									
140	38	120	A) 105x85 75x55 85x65	B) 180	9	180	45			5121.14-G	29.80	5221.14-G	42.00	5321.14-G	25.90	12.3	5021.14-G	29.50	5721.14-G	41.80									
<b>ZINGUE_SERIE N° 8 'MEDIA' (page 1.9)</b>																													
160	40	150	135x110	105x80	11	195	52			8122.16-G	46.30	8222.16-G	60.70	8322.16-G	40.50	16.3	8022.16-G	46.00	8722.16-G	59.50									
200	50	200	135x110	105x80	11	235	55			8122.20-G	60.90	8222.20-G	72.90	8322.20-G	54.80	16.3	8022.20-G	60.70	8722.20-G	72.00									
<b>INOX_SERIE N° 7 'LEGER' (page 1.9)</b>																													
<b>INOX / ROSTFREI / INOX</b>																													
80	25	50	105x85	80x60	9	106	38			X-7121.08-G	33.30	X-7221.08-G	50.70	X-7321.08-G	27.30	12.3	X-7021.08-G	32.60	X-7721.08-G	50.50									
100	30	75	105x85	80x60	9	128	40			X-7121.10-G	36.80	X-7221.10-G	53.30	X-7321.10-G	30.10	12.3	X-7021.10-G	35.40	X-7721.10-G	53.10									
<b>INOX_SERIE N° 5 'MEDIA' (page 1.9)</b>																													
<b>INOX / ROSTFREI / INOX</b>																													
125	38	100	A) 105x85 75x55 85x65	B) 155	9	155	45			X-5121.12-G	57.50	X-5221.12-G	82.70	X-5321.12-G	46.90	12.3	X-5021.12-G	55.10	X-5721.12-G	81.20									
140	38	110	A) 105x85 75x55 85x65	B) 175	9	175	45			X-5121.14-G	66.60	X-5221.14-G	95.90	X-5321.14-G	56.10	12.3	X-5021.14-G	65.00	X-5721.14-G	93.50									
<b>INOX_SERIE N° 8 'MEDIA' (page 1.9)</b>																													
<b>INOX / ROSTFREI / INOX</b>																													
160	40	150	135x110	105x80	11	195	52			X-8122.16-G	96.80	X-8222.16-G	121.90	X-8322.16-G	86.80	16.3	X-8022.16-G	97.20	X-8722.16-G	120.80									
200	50	200	135x110	105x80	11	235	55			X-8122.20-G	114.20	X-8222.20-G	139.20	X-8322.20-G	104.80	16.3	X-8022.20-G	114.80	X-8722.20-G	138.10									

A) ROULETTE FIXE, PLAQUE / BOCKROLLE, PLATTE / RUOTA FISSA, PIASTRA: 108x87mm – 75x55 / 85x65mm  
B) ROULETTE AVEC TROU, HAUTEUR -4mm / ROLLEN MIT LOCH, BAUHÖHE -4mm / RUOTA CON FORO, ALTEZZA -4mm



AVEC BLOCAGE DE DIRECTION  
MIT RICHTUNGSFESTSTELLER  
CON FRENO DIREZIONALE



ROULETTE FIXE AVEC FREIN  
BOCKROLLE MIT FESTSTELLER  
RUOTA FISSA CON FRENO



**ROULETTES POUR TRANSPORTS ET INDUSTRIES**

SUPPORT EN ACIER, ZINGUÉ-PROMATISÉ  
PIVOTEMENT SUR DOUBLE RANGÉE DE BILLES  
ROUE À PALIER LISSE, ROULEMENT À ROULEAUX OU À BILLES

**TRANSPORT- UND INDUSTRIE-ROLLEN**

GEHÄUSE AUS STAHLBLECH, VERZINKT-PROMATISIERT  
SCHWENKLAGER MIT ZWEIFACHEM KUGELKRAENZ  
RAD MIT GLEITLAGER, ROLLENLAGER ODER KUGELLAGER

**RUOTE PER TRASPORTO ED INDUSTRIA**

SUPPORTI IN LAMIERA D'ACCIAIO, ZINCATO-CROMATO  
PIROETTAMENTO A DOPPIA CORONA DI SFERE  
RUOTA A FORO LISCIO, SU CUSCINETTO A RULLI E A SFERE

**50 – 200 kg****CAOUTCHOUC**

Roue Caoutchouc Plein, noir, roue à palier lisse ou avec roulement à rouleaux, silencieux, corps/roue: Polyamide

**LE CAOUTCHOUC NOIR PEUT LAISSER DES TRACES AU SOL !!**

**GUMMI**

Vollgummirad, schwarz, Rad mit Gleitlager oder Rollenlager, Laufrolle, Radkörper: Polyamid

**SCHWARZGUMMI IST NICHT SPURFREI !!**

**GOMMA**

Ruota in Gomma, nero, ruota a foro liscio o su cuscinetti a rulli, antitraccia, silenziosa, corpo centrale: Poliammide

**LA GOMMA NERA PUÒ SEGNARE IL SUOLO !!**

**Secteurs / Bereiche / Settori**

MAGASIN  
BETRIEB  
COMMERCIO



MANUTENTION  
TRANSPORT  
TRASPORTO



BETON  
BETON  
CEMENTO



GOUDRON  
ASPHALT  
ASFALTO



INDUSTRIE  
INDUSTRIE  
INDUSTRIA

**Applications / Anwendung / Applicazioni****Variantes / Varianten / Varianti**

**-15° - +65° C**  
85 Sh/A



**ROUE**  
PAGE 7.3  
50 – 295 kg

**AVEC PLAQUE / MIT PLATTE / A PIASTRA****AVEC TROU / MIT LOCH / A FORO**

										ROUE PIVOTANTE LENKROLLE RUOTA GIREVOLE		PIVOTANT/FREIN LENKROLLE/BREMS GIREVOLE/FRENO		ROUE FIXE BOCKROLLE RUOTA FISSA												ROUE PIVOTANTE LENKROLLE RUOTA GIREVOLE		PIVOTANT/FREIN LENKROLLE/BREMS GIREVOLE/FRENO				
										Art. N :		Art. N :		Art. N :												Art. N :		Art. N :				
										CHF sans TVA		CHF sans TVA		CHF sans TVA												CHF sans TVA		CHF sans TVA				
<b>ZINGUE_SERIE N° 7 'LEGER' (page 1.9)</b>																																
<b>80</b>	25		<b>50</b>	105x85	80x60	9	106	38		<b>7121.08</b>	14.80	<b>7221.08</b>	25.00	<b>7321.08</b>	13.10	12.3	<b>7021.08</b>	14.80	<b>7721.08</b>	24.80												
<b>100</b>	30		<b>75</b>	105x85	80x60	9	128	40		<b>7121.10</b>	16.50	<b>7221.10</b>	26.40	<b>7321.10</b>	14.80	12.3	<b>7021.10</b>	16.50	<b>7721.10</b>	26.70												
<b>ZINGUE_SERIE N° 5 'MEDIA' (page 1.9)</b>																																
<b>125</b>	38		<b>110</b>	A) 105x85 75x55 85x65		9	B) 155	45		<b>5121.12</b>	23.50	<b>5221.12</b>	34.90	<b>5321.12</b>	19.80	12.3	<b>5021.12</b>	23.30	<b>5721.12</b>	34.60												
<b>150</b>	38		<b>130</b>	A) 105x85 75x55 85x65		9	B) 186	45		<b>5121.15</b>	27.80	<b>5221.15</b>	40.10	<b>5321.15</b>	23.90	12.3	<b>5021.15</b>	27.60	<b>5721.15</b>	39.60												
<b>ZINGUE_SERIE N° 8 'MEDIA' (page 1.9)</b>																																
<b>160</b>	40		<b>150</b>	135x110	105x80	11	195	52		<b>8122.16</b>	42.00	<b>8222.16</b>	56.40	<b>8322.16</b>	36.30	16.3	<b>8022.16</b>	41.80	<b>8722.16</b>	55.20												
<b>200</b>	50		<b>200</b>	135x110	105x80	11	235	55		<b>8122.20</b>	51.60	<b>8222.20</b>	63.50	<b>8322.20</b>	45.40	16.3	<b>8022.20</b>	51.40	<b>8722.20</b>	62.70												

A) ROULETTE FIXE, PLAQUE / BOCKROLLE, PLATTE / RUOTA FISSA, PIASTRA: 108x87mm – 75x55 / 85x65mm

B) ROULETTE AVEC TROU, HAUTEUR -4mm / ROLLEN MIT LOCH, BAUHÖHE -4mm / RUOTA CON FORO, ALTEZZA -4mm



**RABAIS / RABATT / SCONTO : 20% dès/ab/da 100.-- (CHF) / 25% dès/ab/da 500.-- (CHF)**  
RABAIS DE QUANTITE SUR DEMANDE ! MENGENRABATT AUF ANFRAGE ! SCONTO DI QUANTITA SU RICHIESTA !

SUPPORT EN ACIER, ZINGUÉ-PROMATISIÉ  
PIVOTEMENT SUR DOUBLE RANGÉE DE BILLES  
ROUE À PALIER LISSE, ROULEMENT À ROULEAUX OU À BILLES

GEHÄUSE AUS STAHLBLECH, VERZINKT-PROMATISIERT  
SCHWENKLAGER MIT ZWEIFACHEM KUGELKRANZ  
RAD MIT GLEITLAGER, ROLLENLAGER ODER KUGELLAGER

SUPPORTI IN LAMIERA D'ACCIAIO, ZINCATO-CROMATO  
PIROETTAMENTO A DOPPIA CORONA DI SFERE  
RUOTA A FORO LISCIO, SU CUSCINETTO A RULLI E A SFERE

**50 – 395 kg**

**CAOUTCHOUC**

Roue Caoutchouc Plein, noir, roue avec roulement à rouleaux, silencieux, corps/roue: tôle d'acier, zingué

**LE CAOUTCHOUC NOIR PEUT LAISSER DES TRACES AU SOL !!**

**GUMMI**

Vollgummirad, schwarz, Rad mit Rollenlager, Laufruhe, Radkörper: Stahl-Felge, Glanzverzinkt  
**SCHWARZGUMMI IST NICHT SPURFREI !!**

**GOMMA**

Ruota in Gomma, nero, ruota su cuscinetti a rulli, silenziosa, corpo centrale: dischi in acciaio zincato  
**LA GOMMA NERA PUÒ SEGNARE IL SUOLO !!**

Secteurs / Bereiche / Settori



MANUTENTION TRANSPORT TRASPORTO



CONTAINER CONTAINER CASSONETTI

Applications / Anwendung / Applicazioni



BETON BETON CEMENTO



GOUDRON ASPHALT ASFALTO



PAVE PFLASTER-STEIN PAVIMENTO

Variantes / Varianten / Varianti



-15° - +65° C  
85 Sh/A



ROUE PAGE 7.3  
50 – 395 kg

AVEC PLAQUE / MIT PLATTE / A PIASTRA

AVEC TROU / MIT LOCH / A FORO

								ROUE PIVOTANTE LENKROLLE RUOTA GIREVOLE		PIVOTANT/FREIN LENKROLLE/BREMS GIREVOLE/FRENO		ROUE FIXE BOCKROLLE RUOTA FISSA				ROUE PIVOTANTE LENKROLLE RUOTA GIREVOLE		PIVOTANT/FREIN LENKROLLE/BREMS GIREVOLE/FRENO	
mm	mm	Page 1.6	kg	mm	mm	mm	mm	Art. N :	CHF sans TVA	Art. N :	CHF sans TVA	Art. N :	CHF sans TVA	mm	Art. N :	CHF sans TVA	Art. N :	CHF sans TVA	
<b>ZINGUE_SERIE N° 7 'LEGER' (page 1.9)</b>																			
80	25		50	105x85	80x60	9	106	38	7142.08	16.00	7242.08	26.40	7342.08	14.20	12.3	7042.08	16.00	7742.08	26.10
100	30		75	105x85	80x60	9	128	40	7142.10	18.10	7242.10	28.10	7342.10	16.20	12.3	7042.10	17.90	7742.10	28.10
<b>ZINGUE_SERIE N° 5 'MEDIA' (page 1.9)</b>																			
80	25		60	A) 105x85	75x55 85x65	9	B) 108	38	5142.08	18.80	5242.08	29.50	5342.08	14.60	12.3	5042.08	18.40	5742.08	29.20
100	30		85	A) 105x85	75x55 85x65	9	B) 129	38	5142.10	20.90	5242.10	31.60	5342.10	17.00	12.3	5042.10	20.70	5742.10	31.10
125	38		110	A) 105x85	75x55 85x65	9	B) 155	45	5142.12	26.40	5242.12	37.70	5342.12	22.60	12.3	5042.12	26.10	5742.12	37.50
140	38		120	A) 105x85	75x55 85x65	9	B) 180	45	5142.14	30.10	5242.14	42.60	5342.14	26.10	12.3	5042.14	29.80	5742.14	42.20
150	38		130	A) 105x85	75x55 85x65	9	B) 186	45	5142.15	34.00	5242.15	46.40	5342.15	30.00	12.3	5042.15	33.60	5742.15	46.10
<b>ZINGUE_SERIE N° 8 'MEDIA' (page 1.9)</b>																			
160	40		150	135x110	105x80	11	195	52	8142.16	43.90	8242.16	58.50	8342.16	38.60	16.3	8042.16	43.70	8742.16	57.30
200	50		200	135x110	105x80	11	235	55	8142.20	52.20	8242.20	64.40	8342.20	46.30	16.3	8042.20	52.20	8742.20	63.30
<b>ZINGUE_SERIE N° 6 'FORT' (page 1.10)</b>																			
160	40		160	135x110	105x75-80	11	C) 199	55	6142.16	46.70	6242.16	66.10	6342.16	37.50	16.3	6042.16	47.20	6742.16	67.80
180	45		180	135x110	105x75-80	11	C) 229	58	6142.18	48.80	6242.18	67.20	6342.18	39.60	16.3	6042.18	49.10	6742.18	69.20
200	50		210	135x110	105x75-80	11	C) 237	58	6142.20	52.20	6242.20	72.20	6342.20	45.10	16.3	6042.20	54.40	6742.20	74.40
250	60		295	200x160	140x110 160x120	14	C) 300	77	6142.25	181.30	6242.25	202.00	6342.25	146.60	---	---	---	---	---
280	70		395	200x160	140x110 160x120	14	C) 315	77	6142.28	196.90	6242.28	217.70	6342.28	162.20	---	---	---	---	---

A) ROULETTE FIXE, PLAQUE / BOCKROLLE, PLATTE / RUOTA FISSA, PIASTRA: 108x87mm – 75x55 / 85x65mm  
B) ROULETTE AVEC TROU, HAUTEUR -4mm / ROLLEN MIT LOCH, BAUHÖHE -4mm / RUOTA CON FORO, ALTEZZA -4mm  
C) ROULETTE AVEC TROU, HAUTEUR -6mm / ROLLEN MIT LOCH, BAUHÖHE -6mm / RUOTA CON FORO, ALTEZZA -6mm

**RABAIS SPÉCIAL 'SET-CONTAINER' PAGE 5.21 / SPEZIAL-RABATT 'SET-CONTAINER' SEITE 5.21 / SCONTO SPECIALE 'SET-CASSONETTI' PAGINA 5.21 .**

**AVEC BLOCAGE DE DIRECTION  
MIT RICHTUNGSFESTSTELLER  
CON FRENO DIREZIONALE**

**AVEC FREIN ARRIÈRE  
MIT HINTER-FESTSTELLER  
CON FRENO POSTERIORE**





**ROULETTES POUR TRANSPORTS ET INDUSTRIES**

SUPPORT EN ACIER, ZINGUÉ-PROMATISÉ  
PIVOTEMENT SUR DOUBLE RANGÉE DE BILLES  
ROUE À PALIER LISSE, ROULEMENT À ROULEAUX OU À BILLES

**TRANSPORT- UND INDUSTRIE-ROLLEN**

GEHÄUSE AUS STAHLBLECH, VERZINKT-PROMATISIERT  
SCHWENKLAGER MIT ZWEIFACHEM KUGELKRANZ  
RAD MIT GLEITLAGER, ROLLENLAGER ODER KUGELLAGER

**RUOTE PER TRASPORTO ED INDUSTRIE**

SUPPORTI IN LAMIERA D'ACCIAIO, ZINCATO-CROMATO  
PIROETTAMENTO A DOPPIA CORONA DI SFERE  
RUOTA A FORO LISCIO, SU CUSCINETTO A RULLI E A SFERE

200 – 450 kg

**CAOUTCHOUC SUPER-ÉLASTIQUE**

Roue Caoutchouc Super-Élastique, noir, roue avec roulement à billes, silencieux, extra-souple, corps/roue: jante Alu

LE CAOUTCHOUC NOIR PEUT LAISSER DES TRACES AU SOL !!

**ELASTISCH-GUMMI**

Elastisches Vollgummirad, schwarz, Rad mit Kugellager, Laufruhe, extra-weich, Radkörper: Alu-Felge

SCHWARZGUMMI IST NICHT SPURFREI !!

**GOMMA-ELASTICA**

Ruota in Gomma Elastica, nero, ruota su cuscinetti a sfere, silenziosa, grande elasticità, corpo centrale: Alluminio

LA GOMMA NERA PUÒ SEGNARE IL SUOLO !!

Secteurs / Bereiche / Settori



MANUTENTION TRANSPORT TRANSPORTO



TRANSPALETTE PALETTHUBWAGEN TRANSPALETTE

Applications / Anwendung / Applicazioni

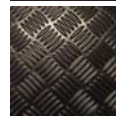

SOL ACIER STAHL ACCIAIO



PAVE PFLASTER-STEIN PAVIMENTO



GOUDRON ASPHALT ASFALTO

Variantes / Varianten / Varianti



-20° +80° C  
70 Sh/A



ROUE PAGE 7.5  
200 – 495 kg



SERIE 55.. PAGE 4.3  
210 – 450 kg



SERIE 9.. PAGE 6.1  
280 – 495 kg



SERIE TH/TW.. PAGE 6.1  
500 – 850 kg

AVEC PLAQUE / MIT PLATTE / A PIASTRA

AVEC TROU / MIT LOCH / A FORO

								ROUE PIVOTANTE LENKROLLE RUOTA GIREVOLE		PIVOTANT/FREIN LENKROLLE/BREMS GIREVOLE/FRENO		ROUE FIXE BOCKROLLE RUOTA FISSA				ROUE PIVOTANTE LENKROLLE RUOTA GIREVOLE		PIVOTANT/FREIN LENKROLLE/BREMS GIREVOLE/FRENO			
								Art. N :		Art. N :		Art. N :		mm		Art. N :		Art. N :			
								CHF sans TVA		CHF sans TVA		CHF sans TVA				CHF sans TVA		CHF sans TVA			
								Prix		Prix		Prix				Prix		Prix			
								Preis		Preis		Preis				Preis		Preis			
								Prezzo		Prezzo		Prezzo				Prezzo		Prezzo			
								mm		mm		mm		mm		mm		mm			
<b>ZINGUE_SERIE N° 5 'MEDIA' (page 1.9)</b>																					
100	40	200	105x85	75x55 85x65	9	129	38	5153.10	48.00	5253.10	59.00	5353.10	43.90	12.3	5053.10	47.80	5753.10	59.00			
<b>ZINGUE_SERIE N° 6 'FORT' (page 1.10)</b>																					
125	50	300	135x110	105x 75-80	11	164	53	6153.12	82.20	6253.12	101.60	6353.12	72.70	16.3	6053.12	82.20	6753.12	102.30			
160	50	350	135x110	105x 75-80	11	199	55	6153.16	87.20	6253.16	105.50	6353.16	77.10	16.3	6053.16	87.50	6753.16	107.30			
180	50	360	135x110	105x 75-80	11	229	58	6153.18	98.40	6253.18	119.40	6353.18	90.70	16.3	6053.18	100.50	6753.18	121.40			
200	50	360	135x110	105x 75-80	11	237	58	6153.20	102.90	6253.20	123.60	6353.20	95.20	16.3	6053.20	103.20	6753.20	126.00			
250	50	395	200x160	140x110 160x120	14	300	77	6153.25	213.70	6253.25	235.30	6353.25	177.20	---	---	---	---	---			
<b>INOX_SERIE N° 5 'MEDIA' (page 1.9)</b>								<b>INOX / ROSTFREI / INOX (2RS)</b>				<b>INOX / ROSTFREI / INOX (2RS)</b>									
A) 100	40	200	105x85	75x55 85x65	9	129	38	X-5153.10	76.90	X-5253.10	103.80	X-5353.10	63.50	12.3	X-5053.10	74.40	X-5753.10	101.50			
<b>INOX_SERIE N° 6 'FORT' (page 1.10)</b>								<b>INOX / ROSTFREI / INOX (2RS)</b>				<b>INOX / ROSTFREI / INOX (2RS)</b>									
A) 125	50	300	135x110	105x 75-80	11	164	53	X-6153.12	145.90	X-6253.12	200.10	X-6353.12	121.60	16.3	X-6053.12	144.90	X-6753.12	199.20			
A) 160	50	350	135x110	105x 75-80	11	199	55	X-6153.16	152.50	X-6253.16	205.40	X-6353.16	127.00	16.3	X-6053.16	151.60	X-6753.16	204.60			
A) 180	50	390	135x110	105x 75-80	11	229	58	X-6153.18	160.70	X-6253.18	220.50	X-6353.18	140.70	16.3	X-6053.18	161.50	X-6753.18	219.60			
A) 200	50	450	135x110	105x 75-80	11	237	58	X-6153.20	170.00	X-6253.20	229.50	X-6353.20	150.00	16.3	X-6053.20	169.20	X-6753.20	228.70			

A) EGALEMENT AVEC ROULEMENT A BILLES EN INOX +CHF 16.00 / AUCH MIT KUGELLAGER AUS ROSTFREI +CHF 16.00 / ANCHE CON CUSCINETTO A SFERE IN INOX +CHF 16.00  
B) ROULETTE FIXE, PLAQUE / BOCKROLLE, PLATTE / RUOTA FISSA, PIASTRA: 108x87mm – 75x55 / 85x65mm  
C) ROULETTE AVEC TROU, HAUTEUR -4mm / ROLLEN MIT LOCH, BAUHÖHE -4mm / RUOTA CON FORO, ALTEZZA -4mm  
D) ROULETTE AVEC TROU, HAUTEUR -6mm / ROLLEN MIT LOCH, BAUHÖHE -6mm / RUOTA CON FORO, ALTEZZA -6mm

**RABAIS SPÉCIAL 'SET-TRANSPALETTE' PAGE 4.7 / SPEZIAL-RABATT 'SET-PALETTHUBWAGEN' SEITE 4.7 / SCONTO SPECIALE 'SET-TRANSPALETTE' PAGINA 4.7**



AVEC BLOCAGE DE DIRECTION  
MIT RICHTUNGSFESTSTELLER  
CON FRENO DIREZIONALE



AVEC FREIN ARRIÈRE  
MIT HINTER-FESTSTELLER  
CON FRENO POSTERIORE



ROULETTE FIXE AVEC FREIN  
BOCKROLLE MIT FESTSTELLER  
RUOTA FISSA CON FRENO



**RABAIS / RABATT / SCONTO : 20% dès/ab/da 100.-- (CHF) / 25% dès/ab/da 500.-- (CHF)**  
RABAIS DE QUANTITE SUR DEMANDE ! MENGENRABATT AUF ANFRAGE ! SCONTO DI QUANTITA SU RICHIESTA !

**ROULETTES POUR TRANSPORTS ET INDUSTRIES**

SUPPORT EN ACIER, ZINGUÉ-PROMATISÉ  
PIVOTEMENT SUR DOUBLE RANGÉE DE BILLES  
ROUE À PALIER LISSE, ROULEMENT À ROULEAUX OU À BILLES

**TRANSPORT- UND INDUSTRIE-ROLLEN**

GEHÄUSE AUS STAHLBLECH, VERZINKT-PROMATISIERT  
SCHWENKLAGER MIT ZWEIFACHEM KUGELKRANZ  
RAD MIT GLEITLAGER, ROLLENLAGER ODER KUGELLAGER

**RUOTE PER TRASPORTO ED INDUSTRIE**

SUPPORTI IN LAMIERA D'ACCIAIO, ZINCATO-CROMATO  
PIROETTAMENTO A DOPPIA CORONA DI SFERE  
RUOTA A FORO LISCIO, SU CUSCINETTO A RULLI E A SFERE

120 – 250 kg

**CAOUTCHOUC SUPER-ÉLASTIQUE**

Roue Caoutchouc Super-Elastique, bleu/gris, roue avec roulement à rouleaux ou à billes, silencieux, non-tachant, extra-souple, corps/roue: Nylon 6

RECOMMANDÉ POUR LES HOPITAUX, HALLES POLYVALENTES ET L'ALIMENTATION

**ELASTISCH-GUMMI**

Elastisches Vollgummirad, blau/grau, Rad mit Rollenlager oder Kugellager, Laufruhe, spurfrei, extra-weich, Radkörper: Nylon 6

EMPFOHLEN FÜR DIE SPITÄLER, MEHRZWECKHALLEN UND LEBENSMITTEL

**GOMMA-ELASTICA**

Ruota in Gomma Elastica, blu/grigia, ruota su cuscinetti a rulli e a sfere, silenziosa, antitraccia, grande elasticità, corpo centrale: Nylon 6

RACCOMANDATÒ PER L'OSPEDALI, LE CENTRO SPORTIVA ED L'ALIMENTAZIONE

Secteurs / Bereiche / Settori



SALLE DE SPORT  
SPORTHALLE  
CENTR. SPORTI



CUISINE  
KÜCHE  
CUCINA

Applications / Anwendung / Applicazioni

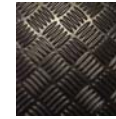

SOL ACIER  
STAHL  
ACCIAIO



PAVE  
PFLASTER-STEIN  
PAVIMENTO



CARRELAGE  
FLIESEN  
PIASTRELLE

Variantes / Varianten / Varianti



-20° - +80° C  
70 Sh/A



ROUE  
PAGE 7.5  
140 - 480 kg



SERIE 9...-TH..  
PAGE 6.1  
350 - 850 kg



ROUE \*C)  
PAGE 7.5  
180 - 400 kg

AVEC PLAQUE / MIT PLATTE / A PIASTRA

AVEC TROU / MIT LOCH / A FORO

								ROUE PIVOTANTE LENKROLLE RUOTA GIREVOLE		PIVOTANT/FREIN LENKROLLE/BREMS GIREVOLE/FRENO		ROUE FIXE BOCKROLLE RUOTA FISSA				ROUE PIVOTANTE LENKROLLE RUOTA GIREVOLE		PIVOTANT/FREIN LENKROLLE/BREMS GIREVOLE/FRENO	
mm	mm	Page 1.6	kg	mm	mm	mm	mm	Art. N :	CHF sans TVA	Art. N :	CHF sans TVA	Art. N :	CHF sans TVA	mm	Art. N :	CHF sans TVA	Art. N :	CHF sans TVA	
<b>ZINGUE_SERIE N° 7 'LEGER' (page 1.9)</b>																			
80	30		120	105x85	80x60	9	106	38	7132.08	36.00	7232.08	46.90	7332.08	34.20	12.3	7032.08	36.00	7732.08	46.30
100	32		140	105x85	80x60	9	128	40	7132.10	28.90	7232.10	39.80	7332.10	27.10	12.3	7032.10	28.90	7732.10	39.40
<b>ZINGUE_SERIE N° 5 'MEDIA' (page 1.9)</b>																			
80	30		140	A) 105x85	75x55 85x65	9	B) 108	38	5132.08	38.90	5232.08	50.10	5332.08	34.40	12.3	5032.08	38.50	5732.08	49.80
100	32		200	A) 105x85	75x55 85x65	9	B) 129	38	5132.10	32.00	5232.10	43.00	5332.10	28.00	12.3	5032.10	31.80	5732.10	42.80
125	40		210	A) 105x85	75x55 85x65	9	B) 155	45	5132.12	42.80	5232.12	54.70	5332.12	38.90	12.3	5032.12	42.30	5732.12	54.20
c) 100	36		180	A) 105x85	75x55 85x65	9	129	33	5133.10-G	50.60	5233.10-G	61.60	5333.10-G	43.70	12.3	5033.10-G	50.20	5733.10-G	61.00
c) 125	38		210	A) 105x85	75x55 85x65	9	155	35	5133.12-G	55.30	5233.12-G	67.60	5333.12-G	49.10	12.3	5033.12-G	53.00	5733.12-G	65.30
<b>INOX_SERIE N° 7 'LEGER' (page 1.9)</b>																			
										INOX / ROSTFREI / INOX					INOX / ROSTFREI / INOX				
100	32		170	105x85	80x60	9	128	40	X-7132.10	49.80	X-7232.10	66.40	X-7332.10	42.90	12.3	X-7032.10	48.40	X-7732.10	66.10
<b>INOX_SERIE N° 5 'MEDIA' (page 1.9)</b>																			
										INOX / ROSTFREI / INOX					INOX / ROSTFREI / INOX				
100	32		200	A) 105x85	75x55 85x65	9	B) 129	38	X-5132.10	62.90	X-5232.10	88.60	X-5332.10	49.80	12.3	X-5032.10	60.40	X-5732.10	86.50
125	40		250	A) 105x85	75x55 85x65	9	B) 155	45	X-5132.12	78.00	X-5232.12	102.80	X-5332.12	66.40	12.3	X-5032.12	75.40	X-5732.12	101.00
c) 100	36		180	A) 105x85	75x55 85x65	9	129	33	X-5133.10-G	81.50	X-5233.10-G	107.20	X-5333.10-G	65.50	12.3	X-5033.10-G	78.70	X-5733.10-G	104.70
c) 125	38		250	A) 105x85	75x55 85x65	9	155	35	X-5133.12-G	90.50	X-5233.12-G	115.80	X-5333.12-G	76.60	12.3	X-5033.12-G	86.00	X-5733.12-G	112.10

- A) ROULETTE FIXE, PLAQUE / BOCKROLLE, PLATTE / RUOTA FISSA, PIASTRA: 108x87mm - 75x55 / 85x65mm
- B) ROULETTE AVEC TROU, HAUTEUR -4mm / ROLLEN MIT LOCH, BAUHÖHE -4mm / RUOTA CON FORO, ALTEZZA -4mm
- C) CAOUTCHOUC-ELASTIQUE GRIS +PARE-FILS DE PROTECTION DU ROULEMENT (LAVAGE PAR STÉRILISATION) / ELASTISCH-GUMMI GRAU +FADENFÄNGER ZUM LAGERSCHUTZ (WASCHEN DURCH STERILISATION) / GOMMA-ELASTICA +PROTEZIONE DEL CUSCINETTO (LAVAGGIO DI STERILIZZAZIONE)

RABAIS SPÉCIAL 'SET FLIGHT-CASES' PAGE 5.21 / SPEZIAL-RABATT 'SET FLIGHT-CASES' SEITE 5.21 / SCONTO SPECIALE 'SET FLIGHT-CASES' PAGINA 5.21

AVEC BLOCAGE DE DIRECTION  
MIT RICHTUNGSFESTSTELLER  
CON FRENO DIREZIONALE

ROULETTE FIXE AVEC FREIN  
BOCKROLLE MIT FESTSTELLER  
RUOTA FISSA CON FRENO



**ROULETTES POUR TRANSPORTS ET INDUSTRIES**

SUPPORT EN ACIER, ZINGUÉ-PROMATISÉ  
PIVOTEMENT SUR DOUBLE RANGÉE DE BILLES  
ROUE À PALIER LISSE, ROULEMENT À ROULEAUX OU À BILLES

**TRANSPORT- UND INDUSTRIE-ROLLEN**

GEHÄUSE AUS STAHLBLECH, VERZINKT-PROMATISIERT  
SCHWENKLAGER MIT ZWEIFACHEM KUGELKRANZ  
RAD MIT GLEITLAGER, ROLLENLAGER ODER KUGELLAGER

**RUOTE PER TRASPORTO ED INDUSTRIE**

SUPPORTI IN LAMIERA D'ACCIAIO, ZINCATO-CROMATO  
PIROETTAMENTO A DOPPIA CORONA DI SFERE  
RUOTA A FORO LISCIO, SU CUSCINETTO A RULLI E A SFERE

250 – 450 kg

**CAOUTCHOUC SUPER-ÉLASTIQUE**

Roue Caoutchouc Super-Elastique, bleu/gris, roue avec roulement à rouleaux ou à billes, silencieux, non-tachant, extra-souple, corps/roue: Nylon 6

RECOMMANDÉ POUR LES HOPITAUX, HALLES POLYVALENTES ET L'ALIMENTATION

**ELASTISCH-GUMMI**

Elastisches Vollgummirad, blau/grau, Rad mit Rollenlager oder Kugellager, Laufruhe, spurfrei, extra-weich, Radkörper: Nylon 6

EMPFOHLEN FÜR DIE SPITÄLER, MEHRZWECKHALLEN UND LEBENSMITTEL

**GOMMA-ELASTICA**

Ruota in Gomma Elastica, blu/grigia, ruota su cuscinetti a rulli e a sfere, silenziosa, antitraccia, grande elasticità, corpo centrale: Nylon 6

RACCOMANDATÒ PER L'OSPEDALI, LE CENTRO SPORTIVA ED L'ALIMENTAZIONE

Secteurs / Bereiche / Settori



SALLE DE SPORT  
SPORTHALLE  
CENTR. SPORTI



CUISINE  
KÜCHE  
CUCINA

Applications / Anwendung / Applicazioni

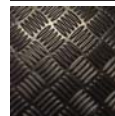

SOL ACIER  
STAHL  
ACCIAIO



PAVE  
PFLASTER-STEIN  
PAVIMENTO

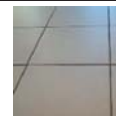

CARRELAGE  
FLIESEN  
PIASTRELLE

Variantes / Varianten / Varianti



-20° - +80° C  
70 Sh/A



ROUE  
PAGE 7.5  
140 - 480 kg



SERIE 9..  
PAGE 6.1  
350 - 850 kg



ROUE \*C)  
PAGE 7.5  
180 - 400 kg

AVEC PLAQUE / MIT PLATTE / A PIASTRA

AVEC TROU / MIT LOCH / A FORO

										ROUE PIVOTANTE LENKROLLE RUOTA GIREVOLE		PIVOTANT/FREIN LENKROLLE/BREMS GIREVOLE/FRENO		ROUE FIXE BOCKROLLE RUOTA FISSA												ROUE PIVOTANTE LENKROLLE RUOTA GIREVOLE		PIVOTANT/FREIN LENKROLLE/BREMS GIREVOLE/FRENO		
										Art. N :		Art. N :		Art. N :												Art. N :		Art. N :		
										CHF sans TVA		CHF sans TVA		CHF sans TVA												CHF sans TVA		CHF sans TVA		
<b>ZINGUE_SERIE N° 8 'MEDIA' (page 1.9)</b>																														
160	50		230	135x110	105x80	11	195	52		8132.16	73.80	8232.16	88.90	8332.16	67.90	16.3	8032.16	73.60	8732.16	87.70										
200	50		250	135x110	105x80	11	235	55		8132.20	88.60	8232.20	101.40	8332.20	82.20	16.3	8032.20	88.40	8732.20	102.30										
<b>ZINGUE_SERIE N° 6 'FORT' (page 1.10)</b>																														
125	40		250	135x110	105x75-80	9	<sup>B)</sup> 164	53		6132.12	57.20	6232.12	75.60	6332.12	46.30	16.3	6032.12	57.20	6732.12	75.60										
160	50		350	135x110	105x75-80	11	<sup>B)</sup> 199	55		6132.16	77.10	6232.16	97.20	6332.16	67.00	16.3	6032.16	77.40	6732.16	99.00										
200	50		360	135x110	105x75-80	11	<sup>B)</sup> 237	58		6132.20	90.70	6232.20	110.00	6332.20	81.30	16.3	6032.20	91.10	6732.20	112.10										
200	50		360	135x110	105x75-80	11	<sup>B)</sup> 237	58		6133.20	96.90	6233.20	118.50	6333.20	89.80	16.3	6033.20	99.60	6733.20	120.70										
250	50		395	200x160	140x110 160x120	14	<sup>B)</sup> 300	77		6133.25	201.80	6233.25	223.40	6333.25	165.40	---	---	---	---	---										
<sup>C)</sup> 160	48		300	135x110	105x75-80	11	199	55		6133.16-G	92.10	6233.16-G	115.10	6333.16-G	83.80	16.3	6033.16-G	93.20	6733.16-G	117.40										
<sup>C)</sup> 200	48		360	135x110	105x75-80	11	237	58		6133.20-G	102.90	6233.20-G	128.90	6333.20-G	94.90	16.3	6033.20-G	105.20	6733.20-G	133.10										
<b>INOX_SERIE N° 8 'MEDIA' (page 1.9)</b>																														
										INOX / ROSTFREI / INOX		INOX / ROSTFREI / INOX		INOX / ROSTFREI / INOX												INOX / ROSTFREI / INOX		INOX / ROSTFREI / INOX		
160	50		260	135x110	105x80	11	195	52		X-8132.16	123.30	X-8232.16	148.50	X-8332.16	114.80	16.3	X-8032.16	124.20	X-8732.16	147.40										
200	50		280	135x110	105x80	11	235	55		X-8132.20	135.70	X-8232.20	158.70	X-8332.20	126.80	16.3	X-8032.20	136.40	X-8732.20	157.90										
<b>INOX_SERIE N° 6 'FORT' (page 1.10)</b>																														
										INOX / ROSTFREI / INOX		INOX / ROSTFREI / INOX		INOX / ROSTFREI / INOX												INOX / ROSTFREI / INOX		INOX / ROSTFREI / INOX		
125	40		250	135x110	105x75-80	9	<sup>B)</sup> 164	53		X-6132.12	110.00	X-6232.12	156.10	X-6332.12	85.70	16.3	X-6032.12	110.00	X-6732.12	155.30										
160	50		350	135x110	105x75-80	11	<sup>B)</sup> 199	55		X-6132.16	142.60	X-6232.16	194.80	X-6332.16	118.30	16.3	X-6032.16	141.80	X-6732.16	194.00										
200	50		420	135x110	105x75-80	11	<sup>B)</sup> 237	58		X-6132.20	153.40	X-6232.20	208.90	X-6332.20	132.50	16.3	X-6032.20	152.70	X-6732.20	208.00										
<sup>A)</sup> 200	50		450	135x110	105x75-80	11	<sup>B)</sup> 237	58		X-6133.20	168.80	X-6233.20	229.90	X-6333.20	148.20	16.3	X-6033.20	169.70	X-6733.20	229.00										
<sup>C)</sup> 160	48		300	135x110	105x75-80	11	199	55		X-6133.16-G	157.60	X-6233.16-G	212.70	X-6333.16-G	135.10	16.3	X-6033.16-G	158.70	X-6733.16-G	214.90										
<sup>C)</sup> 200	48		400	135x110	105x75-80	11	237	58		X-6133.20-G	165.60	X-6233.20-G	227.80	X-6333.20-G	146.00	16.3	X-6033.20-G	167.90	X-6733.20-G	232.00										

A) EGALEMENT AVEC ROULEMENT A BILLES EN INOX +CHF 16.00 / AUCH MIT KUGELLAGER AUS ROSTFREI +CHF 16.00 / ANCHE CON CUSCINETTO A SFERE IN INOX +CHF 16.00

B) ROULETTE AVEC TROU, HAUTEUR -6mm / ROLLEN MIT LOCH, BAUHÖHE -6mm / RUOTA CON FORO, ALTEZZA -6mm

C) CAOUTCHOUC-ELASTIQUE GRIS +PARE-FILS DE PROTECTION DU ROULEMENT (LAVAGE PAR STÉRILISATION) / ELASTISCH-GUMMI GRAU +FADENFÄNGER ZUM LAGERSCHUTZ (WASCHEN DURCH STERILISATION) / GOMMA-ELASTICA +PROTEZIONE DEL CUSCINETTO (LAVAGGIO DI STERILIZZAZIONE)

**RABAIS / RABATT / SCONTO : 20% dès/ab/da 100.-- (CHF) / 25% dès/ab/da 500.-- (CHF)**  
RABAIS DE QUANTITE SUR DEMANDE ! MENGENRABATT AUF ANFRAGE ! SCONTO DI QUANTITA SU RICHIESTA !



SUPPORT EN ACIER, ZINGUÉ-PROMATISÉ  
PIVOTEMENT SUR DOUBLE RANGÉE DE BILLES  
ROUE À PALIER LISSE, ROULEMENT À ROULEAUX OU À BILLES

GEHÄUSE AUS STAHLBLECH, VERZINKT-PROMATISIERT  
SCHWENKLAGER MIT ZWEIFACHEM KUGELKRANZ  
RAD MIT GLEITLAGER, ROLLENLAGER ODER KUGELLAGER

SUPPORTI IN LAMIERA D'ACCIAIO, ZINCATO-CROMATO  
PIROETTAMENTO A DOPPIA CORONA DI SFERE  
RUOTA A FORO LISCIO, SU CUSCINETTO A RULLI E A SFERE

120 – 140 kg

**PNEU-SOFT**

Roue à Pneu Plein en Polyuréthane-SOFT, gris, roue avec roulement à rouleaux ou à billes, non-tachant, silencieux, extra-souple, corps/roue: Nylon renforcé de fibres de verre  
**EXTRA-SOUPLE ET INCREVABLE, RECOMMANDÉ POUR LES HÔPITAUX**

**SOFT-REIFEN**

Rad mit Vollreifen aus Polyurethan-SOFT, grau, Rad mit Rollenlager oder Kugellager, spurfrei, Laufruhe, extra-weich, Radkörper: Nylon und Glasfaser Verbindung  
**EXTRA-WEICH UND PANNENSICHER, EMPFOHLEN FÜR SPITÄLER**

**PNEUMATICHE-SOFT**

Ruota in Pneumatica Piena in Poliuretano-SOFT, grigia, ruota su cuscinetti a rulli e a sfere, antitraccia, silenziosa, grande elasticità, corpo centrale: Nylon rinforzato con fibra di vetro  
**GRANDE ELASTICITÀ ED A PROVA DI FORATURA, RACCOMANDATÒ PER OSPEDALI**

**Secteurs / Bereiche / Settori**



CUISINE  
KÜCHE  
CUCINA



HOPITAL  
SPITAL  
OSPEDALE

**Applications / Anwendung / Applicazioni**



CARRELAGE  
FLIESEN  
PIASTRELLE



PAVE  
PFLASTER-STEIN  
PAVIMENTO



SOL ACIER  
STAHL  
ACCIAIO

**Variantes / Varianten / Varianti**



-20° - +60° C  
50-60 Sh/A



**ROUE**  
PAGE 7.6  
120 – 140 kg



**ROUE**  
PAGE 7.6  
120 – 140 kg



**SERIE 2..**  
PAGE 3.3  
80 kg



**SERIE H..**  
PAGE 3.11  
80 kg

**AVEC PLAQUE / MIT PLATTE / A PIASTRA**

**AVEC TROU / MIT LOCH / A FORO**

										ROUE PIVOTANTE LENKROLLE RUOTA GIREVOLE		PIVOTANT/FREIN LENKROLLE/BREMS GIREVOLE/FRENO		ROUE FIXE BOCKROLLE RUOTA FISSA												ROUE PIVOTANTE LENKROLLE RUOTA GIREVOLE		PIVOTANT/FREIN LENKROLLE/BREMS GIREVOLE/FRENO	
mm	mm	Page 1.6	kg	mm	mm	mm	mm	mm	mm	Art. N :	CHF sans TVA	Art. N :	CHF sans TVA	Art. N :	CHF sans TVA	mm	Art. N :	CHF sans TVA	Art. N :	CHF sans TVA									
<b>ZINGUE_SERIE N° 5 'MEDIA' (page 1.9)</b>																													
A)	150	32	80	B)	105x85	75x55 85x65	9	C)	186	45	51 SOF 15	46.70	52 SOF 15	59.80	53 SOF 15	42.30	12.3	50 SOF 15	46.40	57 SOF 15	59.40								
<b>ZINGUE_SERIE N° 8 'MEDIA' (page 1.9)</b>																													
200	50	100	135x110	105x80	11	235	55	81 DCR 20	61.60	82 DCR 20	77.10	83 DCR 20	56.00	16.3	80 DCR 20	62.50	87 DCR 20	75.70											
200	50	100	135x110	105x80	11	235	55	81 DCK 20	71.50	82 DCK 20	86.90	83 DCK 20	66.00	16.3	80 DCK 20	72.40	87 DCK 20	85.70											
<b>INOX_SERIE N° 5 'MEDIA' (page 1.9)</b>																													
<b>INOX / ROSTFREI / INOX</b>																													
A)	150	32	80	B)	105x85	75x55 85x65	9	C)	186	45	X-51 SOF 15	81.60	X-52 SOF 15	111.40	X-53 SOF 15	71.50	12.3	X-50 SOF 15	80.20	X-57 SOF 15	109.10								
<b>INOX_SERIE N° 8 'MEDIA' (page 1.9)</b>																													
<b>INOX / ROSTFREI / INOX</b>																													
200	50	100	135x110	105x80	11	235	55	X-81 DCR 20	113.70	X-82 DCR 20	138.30	X-83 DCR 20	105.70	16.3	X-80 DCR 20	115.40	X-87 DCR 20	137.40											
200	50	100	135x110	105x80	11	235	55	X-81 DCK 20	117.00	X-82 DCK 20	141.70	X-83 DCK 20	109.10	16.3	X-80 DCK 20	116.60	X-87 DCK 20	140.70											

A) ROUE AVEC JANTE À RAYON / RAD MIT SPEICHEN-FELGE / CON CORPO A RAZZE  
B) ROULETTE FIXE, PLAQUE / BOCKROLLE, PLATTE / RUOTA FISSA, PIASTRA: 108x87mm – 75x55 / 85x65mm  
C) ROULETTE AVEC TROU, HAUTEUR -4mm / ROLLEN MIT LOCH, BAUHÖHE -4mm / RUOTA CON FORO, ALTEZZA -4mm



**ROULETTES POUR TRANSPORTS ET INDUSTRIES**

SUPPORT EN ACIER, ZINGUÉ-PROMATISÉ  
PIVOTEMENT SUR DOUBLE RANGÉE DE BILLES  
ROUE À PALIER LISSE, ROULEMENT À ROULEAUX OU À BILLES

**TRANSPORT- UND INDUSTRIE-ROLLEN**

GEHÄUSE AUS STAHLBLECH, VERZINKT-PROMATISIERT  
SCHWENKLAGER MIT ZWEIFACHEM KUGELKRANZ  
RAD MIT GLEITLAGER, ROLLENLAGER ODER KUGELLAGER

**RUOTE PER TRASPORTO ED INDUSTRIE**

SUPPORTI IN LAMIERA D'ACCIAIO, ZINCATO-CROMATO  
PIROETTAMENTO A DOPPIA CORONA DI SFERE  
RUOTA A FORO LISCIO, SU CUSCINETTO A RULLI E A SFERE

140 – 200 kg

**PNEUMATIQUE**

Roue à Pneumatique, gris ou noir, roue avec roulement à rouleaux, silencieux, extra-souple, corps/roue: Polyamide ou en tôle d'acier zinguée  
**EXTRA-SOUPLE, GRIS - NON-TACHANT**

**LUFT-REIFEN**

Rad mit Luftreifen, grau oder schwarz, Rad mit Rollenlager, Laufruhe, extra-weich, Radkörper: Polyamid oder mit Stahl-Felge Glanzverzinkt  
**EXTRA-WEICH, GRAU - SPURFREI**

**PNEUMATICHE**

Ruota in Pneumatica, grigia o nera, ruota su cuscinetti a rulli e a sfere, silenziosa, grande elasticità, corpo centrale: Poliammide o dischi in acciaio zincato  
**GRANDE ELASTICITÀ, GRIGIA - ANTITRACCIA**

**Secteurs / Bereiche / Settori**

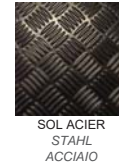

**Applications / Anwendung / Applicazioni**



**Variantes / Varianten / Varianti**



**AVEC PLAQUE / MIT PLATTE / A PIASTRA**

**AVEC TROU / MIT LOCH / A FORO**

										ROUE PIVOTANTE LENKROLLE RUOTA GIREVOLE	PRIX Preis Prezzo	PIVOTANT/FREIN LENKROLLE/BREMS GIREVOLE/FRENO	PRIX Preis Prezzo	ROUE FIXE BOCKROLLE RUOTA FISSA	PRIX Preis Prezzo											ROUE PIVOTANTE LENKROLLE RUOTA GIREVOLE	PRIX Preis Prezzo	PIVOTANT/FREIN LENKROLLE/BREMS GIREVOLE/FRENO	PRIX Preis Prezzo	
mm	mm	Page 1.6	kg	mm	mm	mm	mm	mm	mm	Art. N :	CHF sans TVA	Art. N :	CHF sans TVA	Art. N :	CHF sans TVA	mm	Art. N :	CHF sans TVA	Art. N :	CHF sans TVA										
<b>ZINGUE_SERIE N° 8 'MEDIA' (page 1.9)</b>																				8182.20-P	79.70	8282.20-P	94.50	8382.20-P	74.50	16.3	8082.20-P	80.60	8782.20-P	93.40
<b>INOX_SERIE N° 8 'MEDIA' (page 1.9)</b>																				X-8182.20-P	133.60	X-8282.20-P	158.10	X-8382.20-P	125.60	16.3	X-8082.20-P	135.30	X-8782.20-P	157.20

										ROUE PIVOTANTE LENKROLLE RUOTA GIREVOLE	PRIX Preis Prezzo	PIVOTANT/FREIN LENKROLLE/BREMS GIREVOLE/FRENO	PRIX Preis Prezzo	ROUE FIXE BOCKROLLE RUOTA FISSA	PRIX Preis Prezzo					
mm	mm	Page 1.6	kg	mm	mm	mm	mm	mm	mm	Art. N :	CHF sans TVA	Art. N :	CHF sans TVA	Art. N :	CHF sans TVA					
<b>ZINGUE_SERIE N° 6 'FORT' (page 1.10)</b>															6182.26-P	146.00	---	---	6382.26-P	111.10
A) 260	85		200	200x160	140x110 160x120	14	B) 305	77		6182.40-P	291.00	---	---	6382.40-P	270.30					

A) AVEC PNEU-PLEIN, INCREVABLE +CHF 16.00 / MIT VOLLREIFEN, PANNENSICHER +CHF 16.00 / CON PNEUMATICA PIENA, A PROVA DI FORATURA +CHF 16.00  
B) ROULETTE AVEC TROU, HAUTEUR -6mm / ROLLEN MIT LOCH, BAUHÖHE -6mm / RUOTA CON FORO, ALTEZZA -6mm

										ROUE PIVOTANTE LENKROLLE RUOTA GIREVOLE	PRIX Preis Prezzo	PIVOTANT/FREIN LENKROLLE/BREMS GIREVOLE/FRENO	PRIX Preis Prezzo	ROUE FIXE BOCKROLLE RUOTA FISSA	PRIX Preis Prezzo					
mm	mm	Page 1.6	kg	mm	mm	mm	mm	mm	mm	Art. N :	CHF sans TVA	Art. N :	CHF sans TVA	Art. N :	CHF sans TVA					
<b>ZINGUE_SERIE N° 6 'FORT' (page 1.10)</b>															6182.26-M	157.90	---	---	6382.26-M	123.30
260	85		200	200x160	140x110 160x120	14	A) 305	77		6183.26-M	170.80	---	---	6383.26-M	136.20					

A) ROULETTE AVEC TROU, HAUTEUR -6mm / ROLLEN MIT LOCH, BAUHÖHE -6mm / RUOTA CON FORO, ALTEZZA -6mm

**RABAIS / RABATT / SCONTO : 20% dès/ab/da 100.-- (CHF) / 25% dès/ab/da 500.-- (CHF)**  
RABAIS DE QUANTITE SUR DEMANDE ! MENGENRABATT AUF ANFRAGE ! SCONTO DI QUANTITA SU RICHIESTA !

**ROULETTES POUR TRANSPORTS ET INDUSTRIES**

SUPPORT EN ACIER, ZINGUÉ-PROMATISIÉ  
PIVOTEMENT SUR DOUBLE RANGÉE DE BILLES  
ROUE À PALIER LISSE, ROULEMENT À ROULEAUX OU À BILLES

**TRANSPORT- UND INDUSTRIE-ROLLEN**

GEHÄUSE AUS STAHLBLECH, VERZINKT-PROMATISIERT  
SCHWENKLAGER MIT ZWEIFACHEM KUGELKRANZ  
RAD MIT GLEITLAGER, ROLLENLAGER ODER KUGELLAGER

**RUOTE PER TRASPORTO ED INDUSTRIE**

SUPPORTI IN LAMIERA D'ACCIAIO, ZINCATO-CROMATO  
PIROETTAMENTO A DOPPIA CORONA DI SFERE  
RUOTA A FORO LISCIO, SU CUSCINETTO A RULLI E A SFERE

120 – 180 kg

**POLYURÉTHANE**

Roue Polyuréthane injecté, gris, roue avec roulement à billes, non-tachant, silencieux  
corps/roue: Nylon 6 renforcé de fibres de verre, résistant aux huiles/grasses/essences...

RECOMMANDÉ POUR LES INDUSTRIES ET LES AGENCEMENTS

**POLYURETHAN**

Rad mit Spritzguss-Polyurethan, grau, Rad mit Kugellager, spurfrei, Laufruhe  
beständigkeit gegen Öl/Fett/Benzin..., Radkörper: Nylon und Glasfaser Verbindung

EMPFOHLEN FÜR INDUSTRIE UND DIE EINRICHTUNGEN

**POLIURETANO**

Ruota rivestimento in Poliuretano iniettato, grigia, ruota su cuscinetti a sfere, antiraccia,  
silencia, resistendo agli oli/grassi/petroli..., corpo centrale: Nylon rinforzato con fibra di vetro

RACCOMANDATÒ PER INDUSTRIA E PER ARREDAMENTO

Secteurs / Bereiche / Settori



HUILE/ESSENCE  
OEL/BENZIN  
OLIV/PETROLI



USINE  
FABRIK  
INDUSTRIA

Applications / Anwendung / Applicazioni



INDUSTRIE  
INDUSTRIE  
INDUSTRIA



PARQUET BOIS  
HOLZ-PARKETT  
PARQUET



TAPIS  
TEPPICH  
MOQUETTE

Variantes / Varianten / Varianti



-25° - +80° C  
85 Sh/A



ROUE  
PAGE 7.7  
60 – 490 kg



SERIE 2..3..  
PAGE 3.5  
60 – 120 kg



SERIE H..  
PAGE 3.12  
100 – 120 kg



SERIE 55..  
PAGE 4.4  
350 – 490 kg

AVEC PLAQUE / MIT PLATTE / A PIASTRA

AVEC TROU / MIT LOCH / A FORO

								ROUE PIVOTANTE LENKROLLE RUOTA GIREVOLE		PIVOTANT/FREIN LENKROLLE/BREMS GIREVOLE/FRENO		ROUE FIXE BOCKROLLE RUOTA FISSA				ROUE PIVOTANTE LENKROLLE RUOTA GIREVOLE		PIVOTANT/FREIN LENKROLLE/BREMS GIREVOLE/FRENO	
mm	mm	Page 1.6	kg	mm	mm	mm	mm	Art. N :	CHF sans TVA	Art. N :	CHF sans TVA	Art. N :	CHF sans TVA	mm	Art. N :	CHF sans TVA	Art. N :	CHF sans TVA	
<b>ZINGUE_SERIE N° 7 'LEGER' (page 1.9)</b>																			
80	32		120	105x85	80x60	9	106	38	7173.08	26.90	7273.08	38.10	7373.08	24.80	12.3	7073.08	26.70	7773.08	37.70
100	32		140	105x85	80x60	9	128	40	7173.10	30.70	7273.10	42.10	7373.10	28.90	12.3	7073.10	30.70	7773.10	41.80
<b>ZINGUE_SERIE N° 5 'MEDIA' (page 1.9)</b>																			
80	32		130	<sup>B)</sup> 105x85	<sup>B)</sup> 75x55 85x65	9	<sup>C)</sup> 108	38	5173.08	30.70	5273.08	41.80	5373.08	26.00	12.3	5073.08	30.40	5773.08	41.40
100	32		150	<sup>B)</sup> 105x85	<sup>B)</sup> 75x55 85x65	9	<sup>C)</sup> 129	38	5173.10	34.60	5273.10	45.80	5373.10	30.40	12.3	5073.10	34.40	5773.10	45.50
125	32		160	<sup>B)</sup> 105x85	<sup>B)</sup> 75x55 85x65	9	<sup>C)</sup> 155	45	5173.12	41.20	5273.12	53.90	5373.12	37.10	12.3	5073.12	40.90	5773.12	53.50
125	46		210	<sup>B)</sup> 105x85	<sup>B)</sup> 75x55 85x65	9	<sup>C)</sup> 155	45	5176.12	51.00	5276.12	63.40	5376.12	47.00	12.3	5076.12	50.70	5776.12	63.20
150	32		180	<sup>B)</sup> 105x85	<sup>B)</sup> 75x55 85x65	9	<sup>C)</sup> 186	45	5173.15	57.80	5273.15	71.50	5373.15	53.50	12.3	5073.15	57.60	5773.15	71.10
<b>INOX_SERIE N° 7 'LEGER' (page 1.9)</b>																			
										INOX / ROSTFREI / INOX (2RS)					INOX / ROSTFREI / INOX (2RS)				
80	32		120	105x85	80x60	9	106	38	X-7173.08	42.80	X-7273.08	59.20	X-7373.08	37.10	12.3	X-7073.08	42.20	X-7773.08	59.00
100	32		140	105x85	80x60	9	128	40	X-7173.10	47.70	X-7273.10	63.40	X-7373.10	41.20	12.3	X-7073.10	46.40	X-7773.10	63.20
<b>INOX_SERIE N° 5 'MEDIA' (page 1.9)</b>																			
										INOX / ROSTFREI / INOX (2RS)					INOX / ROSTFREI / INOX (2RS)				
80	32		130	<sup>B)</sup> 105x85	<sup>B)</sup> 75x55 85x65	9	<sup>C)</sup> 108	38	X-5173.08	57.20	X-5273.08	81.50	X-5373.08	44.10	12.3	X-5073.08	55.00	X-5773.08	79.10
100	32		150	<sup>B)</sup> 105x85	<sup>B)</sup> 75x55 85x65	9	<sup>C)</sup> 129	38	X-5173.10	62.20	X-5273.10	87.50	X-5373.10	49.60	12.3	X-5073.10	59.90	X-5773.10	85.20
125	32		160	<sup>B)</sup> 105x85	<sup>B)</sup> 75x55 85x65	9	<sup>C)</sup> 155	45	X-5173.12	74.70	X-5273.12	101.80	X-5373.12	63.60	12.3	X-5073.12	72.20	X-5773.12	99.60
<sup>A)</sup> 125	46		250	<sup>B)</sup> 105x85	<sup>B)</sup> 75x55 85x65	9	<sup>C)</sup> 155	45	X-5176.12	88.50	X-5276.12	115.20	X-5376.12	77.40	12.3	X-5076.12	86.00	X-5776.12	113.10
150	32		180	<sup>B)</sup> 105x85	<sup>B)</sup> 75x55 85x65	9	<sup>C)</sup> 186	45	X-5173.15	91.20	X-5273.15	119.40	X-5373.15	81.20	12.3	X-5073.15	89.60	X-5773.15	117.30

A) EGALEMENT AVEC ROULEMENT A BILLES EN INOX +CHF 16.00 / AUCH MIT KUGELLAGER AUS ROSTFREI +CHF 16.00 / ANCHE CON CUSCINETTO A SFERE IN INOX +CHF 16.00  
B) ROULETTE FIXE, PLAQUE / BOCKROLLE, PLATTE / RUOTA FISSA, PIASTRA: 108x87mm – 75x55 / 85x65mm  
C) ROULETTE AVEC TROU, HAUTEUR -4mm / ROLLEN MIT LOCH, BAUHÖHE -4mm / RUOTA CON FORO, ALTEZZA -4mm



**ROULETTES POUR TRANSPORTS ET INDUSTRIES**

SUPPORT EN ACIER, ZINGUÉ-PROMATISÉ  
PIVOTEMENT SUR DOUBLE RANGÉE DE BILLES  
ROUE À PALIER LISSE, ROULEMENT À ROULEAUX OU À BILLES

**TRANSPORT- UND INDUSTRIE-ROLLEN**

GEHÄUSE AUS STAHLBLECH, VERZINKT-PROMATISIERT  
SCHWENKLAGER MIT ZWEIFACHEM KUGELKRANZ  
RAD MIT GLEITLAGER, ROLLENLAGER ODER KUGELLAGER

**RUOTE PER TRASPORTO ED INDUSTRIE**

SUPPORTI IN LAMIERA D'ACCIAIO, ZINCATO-CROMATO  
PIROETTAMENTO A DOPPIA CORONA DI SFERE  
RUOTA A FORO LISCIO, SU CUSCINETTO A RULLI E A SFERE

230 – 480 kg

**POLYURÉTHANE**

Roue Polyuréthane injecté, gris, roue avec roulement à billes, non-tachant, silencieux  
corps/roue: Nylon 6 renforcé de fibres de verre, résistant aux huiles/graisse/essences...

RECOMMANDÉ POUR LES INDUSTRIES ET LES AGENCEMENTS

**POLYURETHAN**

Rad mit Spritzguss-Polyurethan, grau, Rad mit Kugellager, spurfrei, Laufruhe  
beständigkeit gegen Öl/Fett/Benzin..., Radkörper: Nylon und Glasfaser Verbindung

EMPFOHLEN FÜR INDUSTRIE UND DIE EINRICHTUNGEN

**POLIURETANO**

Ruota rivestimento in Poliuretano iniettato, grigia, ruota su cuscinetti a sfere, antitraccia,  
silenziosa, resistendo agli oli/grassi/petroli..., corpo centrale: Nylon rinforzato con fibra di vetro

RACCOMANDATÒ PER INDUSTRIA E PER ARREDAMENTO

Secteurs / Bereiche / Settori



HUILE/ESSENCE  
ÖL/BENZIN  
OLI/PETROLI



USINE  
FABRIK  
INDUSTRIA

Applications / Anwendung / Applicazioni



INDUSTRIE  
INDUSTRIE  
INDUSTRIA



PARQUET BOIS  
HOLZ-PARKETT  
PARQUET



TAPIS  
TEPPICH  
MOQUETTE

Variantes / Varianten / Varianti



-25° - +80° C  
85 Sh/A



ROUE  
PAGE 7.7  
60 – 490 kg



SERIE 2..3..  
PAGE 3.5  
60 – 120 kg



SERIE 55..  
PAGE 4.4  
350 – 490 kg



SERIE 9..TH..  
PAGE 6.3  
390 – 950 kg

AVEC PLAQUE / MIT PLATTE / A PIASTRA

AVEC TROU / MIT LOCH / A FORO

										ROUE PIVOTANTE LENKROLLE RUOTA GIREVOLE		PIVOTANT/FREIN LENKROLLE/BREMS GIREVOLE/FRENO		ROUE FIXE BOCKROLLE RUOTA FISSA												ROUE PIVOTANTE LENKROLLE RUOTA GIREVOLE		PIVOTANT/FREIN LENKROLLE/BREMS GIREVOLE/FRENO	
										Art. N :		Art. N :		Art. N :												Art. N :		Art. N :	
										CHF sans TVA		CHF sans TVA		CHF sans TVA												CHF sans TVA		CHF sans TVA	
<b>ZINGUE_SERIE N° 8 'MEDIA' (page 1.9)</b>																													
160	46		230	135x110	105x80	11	195	52		8176.16	71.30	8276.16	86.50	8376.16	65.40	16.3	8076.16	72.10	8776.16	85.20									
200	50		250	135x110	105x80	11	235	55		8176.20	86.70	8276.20	101.50	8376.20	80.20	16.3	8076.20	86.50	8776.20	100.40									
<b>ZINGUE_SERIE N° 6 'FORT' (page 1.10)</b>																													
125	46		350	135x110	105x75-80	11	<sup>B)</sup> 164	53		6176.12	67.60	6276.12	85.70	6376.12	57.80	16.3	6076.12	66.40	6776.12	86.40									
160	46		360	135x110	105x75-80	11	<sup>B)</sup> 199	55		6176.16	77.60	6276.16	95.60	6376.16	67.60	16.3	6076.16	77.60	6776.16	97.80									
200	50		360	135x110	105x75-80	11	<sup>B)</sup> 237	58		6176.20	89.80	6276.20	110.90	6376.20	82.20	16.3	6076.20	92.20	6776.20	113.00									
<b>INOX_SERIE N° 8 'MEDIA' (page 1.9)</b>										<b>INOX / ROSTFREI / INOX (2RS)</b>										<b>INOX / ROSTFREI / INOX (2RS)</b>									
<sup>A)</sup> 160	46		260	135x110	105x80	11	195	52		X-8176.16	119.40	X-8276.16	143.50	X-8376.16	111.00	16.3	X-8076.16	121.30	X-8776.16	142.50									
<sup>A)</sup> 200	50		280	135x110	105x80	11	235	55		X-8176.20	136.00	X-8276.20	159.70	X-8376.20	127.60	16.3	X-8076.20	135.30	X-8776.20	158.70									
<b>INOX_SERIE N° 6 'FORT' (page 1.10)</b>										<b>INOX / ROSTFREI / INOX (2RS)</b>										<b>INOX / ROSTFREI / INOX (2RS)</b>									
<sup>A)</sup> 125	46		390	135x110	105x75-80	11	<sup>B)</sup> 164	53		X-6176.12	135.60	X-6276.12	185.80	X-6376.12	112.30	16.3	X-6076.12	133.40	X-6776.12	185.10									
<sup>A)</sup> 160	46		460	135x110	105x75-80	11	<sup>B)</sup> 199	55		X-6176.16	146.50	X-6276.16	196.70	X-6376.16	122.10	16.3	X-6076.16	145.30	X-6776.16	195.90									
<sup>A)</sup> 200	50		480	135x110	105x75-80	11	<sup>B)</sup> 237	58		X-6176.20	159.90	X-6276.20	217.10	X-6376.20	140.70	16.3	X-6076.20	160.70	X-6776.20	216.20									

A) EGALEMENT AVEC ROULEMENT A BILLES EN INOX +CHF 16.00 / AUCH MIT KUGELLAGER AUS ROSTFREI +CHF 16.00 / ANCHE CON CUSCINETTO A SFERE IN INOX +CHF 16.00  
B) ROULETTE AVEC TROU, HAUTEUR -6mm / ROLLEN MIT LOCH, BAUHÖHE -6mm / RUOTA CON FORO, ALTEZZA -6mm



AVEC BLOCAGE DE DIRECTION  
MIT RICHTUNGSFESTSTELLER  
CON FRENO DIREZIONALE



AVEC FREIN ARRIÈRE  
MIT HINTER-FESTSTELLER  
CON FRENO POSTERIORE



ROULETTE FIXE AVEC FREIN  
BOCKROLLE MIT FESTSTELLER  
RUOTA FISSA CON FRENO



**RABAIS / RABATT / SCONTO : 20% dès/ab/da 100.-- (CHF) / 25% dès/ab/da 500.-- (CHF)**  
RABAIS DE QUANTITE SUR DEMANDE ! MENGENRABATT AUF ANFRAGE ! SCONTO DI QUANTITA SU RICHIESTA !

**ROULETTES POUR TRANSPORTS ET INDUSTRIES**

SUPPORT EN ACIER, ZINGUÉ-PROMATISÉ  
PIVOTEMENT SUR DOUBLE RANGÉE DE BILLES  
ROUE À PALIER LISSE, ROULEMENT À ROULEAUX OU À BILLES

**TRANSPORT- UND INDUSTRIE-ROLLEN**

GEHÄUSE AUS STAHLBLECH, VERZINKT-PROMATISIERT  
SCHWENKLAGER MIT ZWEIFACHEM KUGELKRANZ  
RAD MIT GLEITLAGER, ROLLENLAGER ODER KUGELLAGER

**RUOTE PER TRASPORTO ED INDUSTRIA**

SUPPORTI IN LAMIERA D'ACCIAIO, ZINCATO-CROMATO  
PIROETTAMENTO A DOPPIA CORONA DI SFERE  
RUOTA A FORO LISCIO, SU CUSCINETTO A RULLI E A SFERE

120 – 180 kg

**POLYURÉTHANE-ANTISTATIQUE**

Roue Polyuréthane injecté, gris, roue avec roulement à billes, non-tachant, silencieux résistant aux huiles/grasses/essences..., corps/roue: Nylon renforcé de fibres de verre  
**AVEC ROUES ANTISTATIQUES, RECOMMANDÉ POUR LES HÔPITAUX ET L'INDUSTRIE**

**POLYURETHAN-ANTISTATISCH**

Rad mit Spritzguss-Polyurethan, grau, Rad mit Kugellager, spurfrei, Laufruhe beständigkeit gegen Öl/Fett/Benzin..., Radkörper: Nylon und Glasfaser Verbindung  
**MIT ANTISTATISCH-RÄDERN, EMPFOHLEN FÜR SPITÄLER UND INDUSTRIE**

**POLIURETANO-ANTISTATICO**

Ruota rivestimento in Poliuretano iniettato, grigia, ruota su cuscinetti a sfere, antiraccia, silenziosa, resistendo agli oli/grassi/petroli..., corpo centrale: Nylon rinforzato con fibra di vetro  
**CON ANTISTATICO-RUOTE, RACCOMANDATÒ PER OSPEDALI ED INDUSTRIA**

Secteurs / Bereiche / Settori



HUILE/ESSENCE  
ÖL/BENZIN  
OLIV/PETROLI



HOPITAL  
SPITAL  
HOSPITAL

Applications / Anwendung / Applicazioni



ANTISTATIQUE  
ANTISTATISCH  
ANTISTATICO

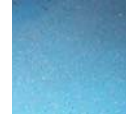

INDUSTRIE  
INDUSTRIE  
INDUSTRIA



CARRELAGE  
FLIESEN  
PIASTRELLE

Variantes / Varianten / Varianti



-25° - +80° C  
87 Sh/A



ROUE  
PAGE 7.8  
60 – 490 kg



SERIE 2...3...  
PAGE 3.6  
60 – 120 kg



SERIE H...  
PAGE 3.12  
100 – 120 kg



SERIE 9...-TH...  
PAGE 6.4  
390 – 950 kg

AVEC PLAQUE / MIT PLATTE / A PIASTRA

AVEC TROU / MIT LOCH / A FORO

								ROUE PIVOTANTE LENKROLLE RUOTA GIREVOLE	Pivotant/Frein LENKROLLE/BREMS GIREVOLE/FRENO		ROUE FIXE BOCKROLLE RUOTA FISSA			ROUE PIVOTANTE LENKROLLE RUOTA GIREVOLE	Pivotant/Frein LENKROLLE/BREMS GIREVOLE/FRENO				
								Prix Preis Prezzo	CHF sans TVA		Prix Preis Prezzo	CHF sans TVA		Prix Preis Prezzo	CHF sans TVA				
								Art. N :	CHF		Art. N :	CHF		Art. N :	CHF				
<b>ZINGUE_SERIE N° 7 'LEGER' (page 1.9)</b>																			
80	32		120	105x85	80x60	9	106	38	7173.08-A	33.50	7273.08-A	44.80	7373.08-A	31.60	12.3	7073.08-A	33.50	7773.08-A	44.40
100	32		140	105x85	80x60	9	128	40	7173.10-A	40.00	7273.10-A	51.00	7373.10-A	38.10	12.3	7073.10-A	40.00	7773.10-A	50.70
<b>ZINGUE_SERIE N° 5 'MEDIA' (page 1.9)</b>																			
80	32		130	<sup>B)</sup> 105x85	<sup>B)</sup> 75x55 <sup>B)</sup> 85x65	9	<sup>C)</sup> 108	38	5173.08-A	36.60	5273.08-A	47.70	5373.08-A	31.90	12.3	5073.08-A	36.20	5773.08-A	47.40
100	32		150	<sup>B)</sup> 105x85	<sup>B)</sup> 75x55 <sup>B)</sup> 85x65	9	<sup>C)</sup> 129	38	5173.10-A	43.00	5273.10-A	54.40	5373.10-A	38.60	12.3	5073.10-A	42.80	5773.10-A	54.10
125	32		160	<sup>B)</sup> 105x85	<sup>B)</sup> 75x55 <sup>B)</sup> 85x65	9	<sup>C)</sup> 155	45	5173.12-A	53.50	5273.12-A	66.10	5373.12-A	49.70	12.3	5073.12-A	53.30	5773.12-A	65.70
125	46		210	<sup>B)</sup> 105x85	<sup>B)</sup> 75x55 <sup>B)</sup> 85x65	9	<sup>C)</sup> 155	45	5176.12-A	71.80	5276.12-A	83.90	5376.12-A	67.90	12.3	5076.12-A	71.50	5776.12-A	83.60
150	32		180	<sup>B)</sup> 105x85	<sup>B)</sup> 75x55 <sup>B)</sup> 85x65	9	<sup>C)</sup> 186	45	5173.15-A	73.70	5273.15-A	86.90	5373.15-A	69.40	12.3	5073.15-A	73.20	5773.15-A	86.70
<b>INOX_SERIE N° 7 'LEGER' (page 1.9)</b>								<b>INOX / ROSTFREI / INOX (2RS)</b>				<b>INOX / ROSTFREI / INOX (2RS)</b>							
80	32		120	105x85	80x60	9	106	38	X-7173.08-A	51.00	X-7273.08-A	68.70	X-7373.08-A	45.10	12.3	X-7073.08-A	50.50	X-7773.08-A	68.40
100	32		140	105x85	80x60	9	128	40	X-7173.10-A	59.00	X-7273.10-A	75.70	X-7373.10-A	52.20	12.3	X-7073.10-A	57.60	X-7773.10-A	75.00
<b>INOX_SERIE N° 5 'MEDIA' (page 1.9)</b>								<b>INOX / ROSTFREI / INOX (2RS)</b>				<b>INOX / ROSTFREI / INOX (2RS)</b>							
80	32		130	<sup>B)</sup> 105x85	<sup>B)</sup> 75x55 <sup>B)</sup> 85x65	9	<sup>C)</sup> 108	38	X-5173.08-A	66.10	X-5273.08-A	87.70	X-5373.08-A	52.40	12.3	X-5073.08-A	63.70	X-5773.08-A	85.20
100	32		150	<sup>B)</sup> 105x85	<sup>B)</sup> 75x55 <sup>B)</sup> 85x65	9	<sup>C)</sup> 129	38	X-5173.10-A	74.60	X-5273.10-A	96.30	X-5373.10-A	61.30	12.3	X-5073.10-A	72.00	X-5773.10-A	94.20
125	32		160	<sup>B)</sup> 105x85	<sup>B)</sup> 75x55 <sup>B)</sup> 85x65	9	<sup>C)</sup> 155	45	X-5173.12-A	88.50	X-5273.12-A	115.60	X-5373.12-A	77.60	12.3	X-5073.12-A	86.40	X-5773.12-A	113.30
<sup>A)</sup> 125	46		280	<sup>B)</sup> 105x85	<sup>B)</sup> 75x55 <sup>B)</sup> 85x65	9	<sup>C)</sup> 155	45	X-5176.12-A	108.00	X-5276.12-A	134.70	X-5376.12-A	96.90	12.3	X-5076.12-A	105.50	X-5776.12-A	132.50
150	32		180	<sup>B)</sup> 105x85	<sup>B)</sup> 75x55 <sup>B)</sup> 85x65	9	<sup>C)</sup> 186	45	X-5173.15-A	108.90	X-5273.15-A	136.90	X-5373.15-A	98.80	12.3	X-5073.15-A	107.20	X-5773.15-A	134.70

A) EGALEMENT AVEC ROULEMENT A BILLES EN INOX +CHF 16.00 / AUCH MIT KUGELLAGER AUS ROSTFREI +CHF 16.00 / ANCHE CON CUSCINETTO A SFERE IN INOX +CHF 16.00  
B) ROULETTE FIXE, PLAQUE / BOCKROLLE, PLATTE / RUOTA FISSA, PIASTRA: 108x87mm – 75x55 / 85x65mm  
C) ROULETTE AVEC TROU, HAUTEUR -4mm / ROLLEN MIT LOCH, BAUHÖHE -4mm / RUOTA CON FORO, ALTEZZA -4mm





**ROULETTES POUR TRANSPORTS ET INDUSTRIES**

SUPPORT EN ACIER, ZINGUÉ-PROMATISIÉ  
PIVOTEMENT SUR DOUBLE RANGÉE DE BILLES  
ROUE À PALIER LISSE, ROULEMENT À ROULEAUX OU À BILLES

**TRANSPORT- UND INDUSTRIE-ROLLEN**

GEHÄUSE AUS STAHLBLECH, VERZINKT-PROMATISIERT  
SCHWENKLAGER MIT ZWEIFACHEM KUGELKRANZ  
RAD MIT GLEITLAGER, ROLLENLAGER ODER KUGELLAGER

**RUOTE PER TRASPORTO ED INDUSTRIA**

SUPPORTI IN LAMIERA D'ACCIAIO, ZINCATO-CROMATO  
PIROETTAMENTO A DOPPIA CORONA DI SFERE  
RUOTA A FORO LISCIO, SU CUSCINETTO A RULLI E A SFERE

120 – 280 kg

**POLYURÉTHANE**

Roue Polyuréthane injecté, rouge/brun, roue à palier lisse ou avec roulement à rouleaux, non-tachant, corps/roue: Nylon 6  
**RÉSISTANT AUX HUILES/GRAISSES/ESSENCES...**

**POLYURETHAN**

Rad mit Spritzguss-Polyurethan, rot/braun, Rad mit Gleitlager oder Rollenlager, spurfrei, Radkörper: Nylon 6  
**BESTÄNDIGKEIT GEGEN OEL/FETT/BENZIN...**

**POLIURETANO**

Ruota rivestimento in Poliuretano iniettato, rosso/marrone, ruota a foro liscio e su cuscinetti a rulli, antitraccia, corpo centrale: Nylon 6  
**RESISTENDO AGLI OLII/GRASSI/PETROLI...**

Secteurs / Bereiche / Settori



HUILE/ESSENCE  
OEL/BENZIN  
OLII/PETROLI



USINE  
FABRIK  
INDUSTRIA

Applications / Anwendung / Applicazioni



GOUDRON  
ASPHALT  
ASFALTO



INDUSTRIE  
INDUSTRIE  
INDUSTRIA



BETON  
BETON  
CEMENTO

Variantes / Varianten / Varianti



-30° - +80° C  
94 Sh/A



ROUE  
PAGE 7.9  
80 – 290 kg



SERIE 2..-3..  
PAGE 3.4  
50 – 120 kg



SERIE 55..  
PAGE 4.5  
210 – 280 kg

AVEC PLAQUE / MIT PLATTE / A PIASTRA

AVEC TROU / MIT LOCH / A FORO

								ROUE PIVOTANTE LENKROLLE RUOTA GIREVOLE		PIVOTANT/FREIN LENKROLLE/BREMS GIREVOLE/FRENO		ROUE FIXE BOCKROLLE RUOTA FISSA				ROUE PIVOTANTE LENKROLLE RUOTA GIREVOLE		PIVOTANT/FREIN LENKROLLE/BREMS GIREVOLE/FRENO	
mm	mm	Page 1.6	kg	mm	mm	mm	mm	Art. N :	CHF sans TVA	Art. N :	CHF sans TVA	Art. N :	CHF sans TVA	mm	Art. N :	CHF sans TVA	Art. N :	CHF sans TVA	
<b>ZINGUE_SERIE N° 7 'LEGER' (page 1.9)</b>																			
80	30		120	105x85	80x60	9	106	38	7171.08	18.40	---	7371.08	16.60	12.3	7071.08	18.40	---	---	
100	30		140	105x85	80x60	9	128	40	7172.10	23.70	---	7372.10	22.10	12.3	7072.10	23.70	---	---	
<b>ZINGUE_SERIE N° 5 'MEDIA' (page 1.9)</b>																			
80	30		170	A) 105x85 75x55 85x65	B) 75x55 85x65	9	108	38	5171.08	22.30	5271.08	34.00	5371.08	17.70	12.3	5071.08	22.10	5771.08	33.70
80	30		180	A) 105x85 75x55 85x65	B) 75x55 85x65	9	108	38	5172.08	25.50	5272.08	37.20	5372.08	20.80	12.3	5072.08	25.20	5772.08	37.00
100	30		210	A) 105x85 75x55 85x65	B) 75x55 85x65	9	129	38	5172.10	27.60	5272.10	38.50	5372.10	23.30	12.3	5072.10	27.30	5772.10	38.50
125	30		210	A) 105x85 75x55 85x65	B) 75x55 85x65	9	155	45	5172.12	31.90	5272.12	44.40	5372.12	27.80	12.3	5072.12	31.60	5772.12	43.90
<b>INOX_SERIE N° 7 'LEGER' (page 1.9)</b>																			
										INOX / ROSTFREI / INOX					INOX / ROSTFREI / INOX				
80	30		150	105x85	80x60	9	106	38	X-7171.08	36.00	X-7271.08	54.00	X-7371.08	29.90	12.3	X-7071.08	35.40	X-7771.08	53.80
100	30		170	105x85	80x60	9	128	40	X-7172.10	44.00	X-7272.10	61.20	X-7372.10	37.10	12.3	X-7072.10	42.70	X-7772.10	60.90
<b>INOX_SERIE N° 5 'MEDIA' (page 1.9)</b>																			
										INOX / ROSTFREI / INOX					INOX / ROSTFREI / INOX				
80	30		180	A) 105x85 75x55 85x65	B) 75x55 85x65	9	108	38	X-5171.08	48.20	X-5271.08	72.50	X-5371.08	35.20	12.3	X-5071.08	46.00	X-5771.08	70.70
80	30		200	A) 105x85 75x55 85x65	B) 75x55 85x65	9	108	38	X-5172.08	52.50	X-5272.08	76.90	X-5372.08	39.50	12.3	X-5072.08	50.40	X-5772.08	74.90
100	30		270	A) 105x85 75x55 85x65	B) 75x55 85x65	9	129	38	X-5172.10	56.00	X-5272.10	81.50	X-5372.10	43.20	12.3	X-5072.10	53.50	X-5772.10	79.30
125	30		280	A) 105x85 75x55 85x65	B) 75x55 85x65	9	155	45	X-5172.12	63.80	X-5272.12	90.90	X-5372.12	53.30	12.3	X-5072.12	61.90	X-5772.12	88.70

A) ROULETTE FIXE, PLAQUE / BOCKROLLE, PLATTE / RUOTA FISSA, PIASTRA: 108x87mm – 75x55 / 85x65mm  
B) ROULETTE AVEC TROU, HAUTEUR -4mm / ROLLEN MIT LOCH, BAUHÖHE -4mm / RUOTA CON FORO, ALTEZZA -4mm



**ROULETTES POUR TRANSPORTS ET INDUSTRIES**

SUPPORT EN ACIER, ZINGUÉ-PROMATISÉ  
PIVOTEMENT SUR DOUBLE RANGÉE DE BILLES  
ROUE À PALIER LISSE, ROULEMENT À ROULEAUX OU À BILLES

**TRANSPORT- UND INDUSTRIE-ROLLEN**

GEHÄUSE AUS STAHLBLECH, VERZINKT-PROMATISIERT  
SCHWENKLAGER MIT ZWEIFACHEM KUGELKRANZ  
RAD MIT GLEITLAGER, ROLLENLAGER ODER KUGELLAGER

**RUOTE PER TRASPORTO ED INDUSTRIA**

SUPPORTI IN LAMIERA D'ACCIAIO, ZINCATO-CROMATO  
PIROETTAMENTO A DOPPIA CORONA DI SFERE  
RUOTA A FORO LISCIO, SU CUSCINETTO A RULLI E A SFERE

350 – 480 kg

**POLYURÉTHANE**

Roue Polyuréthane injecté, rouge/brun, roue avec roulement à billes, non-tachant, corps/roue: Nylon 6 renforcé de fibres de verre  
**RÉSISTANT AUX HUILES/GRAISSES/ESSENCES...**

**POLYURETHAN**

Rad mit Spritzguss-Polyurethan, rot/braun, Rad mit Kugellager, spurfrei, Radkörper: Nylon 6 und Glasfaser Verbindung  
**BESTÄNDIGKEIT GEGEN OEL/FETT/BENZIN...**

**POLIURETANO**

Ruota rivestimento in Poliuretano iniettato, rosso/marrone, ruota su cuscinetti a sfere, antitraccia, corpo centrale: Nylon 6 rinforzato con fibra di vetro  
**RESISTENDO AGLI OLI/GRASSI/PETROLI...**

Secteurs / Bereiche / Settori



HUILE/ESSENCE  
OEL/BENZIN  
OLI/PETROLI



USINE  
FABRIK  
INDUSTRIA

Applications / Anwendung / Applicazioni



GOUDRON  
ASPHALT  
ASFALTO



INDUSTRIE  
INDUSTRIE  
INDUSTRIA



BETON  
BETON  
CEMENTO

Variantes / Varianten / Varianti



-30° - +80° C  
94 Sh/A



ROUE  
PAGE 7.9  
550 – 850 kg



SERIE 55  
PAGE 4.5  
350 – 500 kg



SERIE 9..  
PAGE 6.5  
550 – 850 kg



SERIE TH..  
PAGE 6.5  
1100 - 1600 kg

AVEC PLAQUE / MIT PLATTE / A PIASTRA

AVEC TROU / MIT LOCH / A FORO

										ROUE PIVOTANTE LENKROLLE RUOTA GIREVOLE		PIVOTANT/FREIN LENKROLLE/BREMS GIREVOLE/FRENO		ROUE FIXE BOCKROLLE RUOTA FISSA												ROUE PIVOTANTE LENKROLLE RUOTA GIREVOLE		PIVOTANT/FREIN LENKROLLE/BREMS GIREVOLE/FRENO	
mm	mm	Page 1.6	kg	mm	mm	mm	mm	mm	mm	Art. N :	CHF sans TVA	Art. N :	CHF sans TVA	Art. N :	CHF sans TVA	mm	Art. N :	CHF sans TVA	Art. N :	CHF sans TVA									
<b>ZINGUE_SERIE N° 6 'FORT' (page 1.10)</b>																													
125	46		350	135x110	105x 75-80	11	B) 164	53		61776.12	69.70	62776.12	87.70	63776.12	59.90	16.3	60776.12	68.50	67776.12	88.40									
160	46		360	135x110	105x 75-80	11	B) 199	55		61776.16	79.70	62776.16	97.80	63776.16	69.70	16.3	60776.16	79.70	67776.16	99.90									
200	50		360	135x110	105x 75-80	11	B) 237	58		61776.20	92.50	62776.20	113.50	63776.20	84.80	16.3	60776.20	94.80	67776.20	115.60									
<b>INOX_SERIE N° 6 'FORT' (page 1.10)</b>																													
										<b>INOX / ROSTFREI / INOX (2RS)</b>																			
A) 125	46		470	135x110	105x 75-80	11	B) 164	53		X-61776.12	137.40	X-62776.12	187.80	X-63776.12	114.20	16.3	X-60776.12	135.30	X-67776.12	187.00									
A) 160	46		480	135x110	105x 75-80	11	B) 199	55		X-61776.16	148.30	X-62776.16	198.60	X-63776.16	123.90	16.3	X-60776.16	147.20	X-67776.16	197.80									
A) 200	50		480	135x110	105x 75-80	11	B) 237	58		X-61776.20	162.30	X-62776.20	219.50	X-63776.20	143.10	16.3	X-60776.20	163.20	X-67776.20	218.60									

A) EGALEMENT AVEC ROULEMENT A BILLES EN INOX +CHF 16.00 / AUCH MIT KUGELLAGER AUS ROSTFREI +CHF 16.00 / ANCHE CON CUSCINETTO A SFERE IN INOX +CHF 16.00  
B) ROULETTE AVEC TROU, HAUTEUR -6mm / ROLLEN MIT LOCH, BAUHÖHE -6mm / RUOTA CON FORO, ALTEZZA -6mm

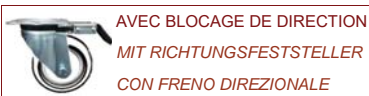

AVEC BLOCAGE DE DIRECTION  
MIT RICHTUNGSFESTSTELLER  
CON FRENO DIREZIONALE



AVEC FREIN ARRIÈRE  
MIT HINTER-FESTSTELLER  
CON FRENO POSTERIORE

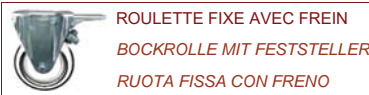

ROULETTE FIXE AVEC FREIN  
BOCKROLLE MIT FESTSTELLER  
RUOTA FISSA CON FRENO



**RABAIS / RABATT / SCONTO : 20% dès/ab/da 100.-- (CHF) / 25% dès/ab/da 500.-- (CHF)**  
RABAIS DE QUANTITE SUR DEMANDE ! MENGENRABATT AUF ANFRAGE ! SCONTO DI QUANTITA SU RICHIESTA !

**ROULETTES POUR TRANSPORTS ET INDUSTRIES**

SUPPORT EN ACIER, ZINGUÉ-PROMATISÉ  
PIVOTEMENT SUR DOUBLE RANGÉE DE BILLES  
ROUE À PALIER LISSE, ROULEMENT À ROULEAUX OU À BILLES

**TRANSPORT- UND INDUSTRIE-ROLLEN**

GEHÄUSE AUS STAHLBLECH, VERZINKT-PROMATISIERT  
SCHWENKLAGER MIT ZWEIFACHEM KUGELKRANZ  
RAD MIT GLEITLAGER, ROLLENLAGER ODER KUGELLAGER

**RUOTE PER TRASPORTO ED INDUSTRIA**

SUPPORTI IN LAMIERA D'ACCIAIO, ZINCATO-CROMATO  
PIROETTAMENTO A DOPPIA CORONA DI SFERE  
RUOTA A FORO LISCIO, SU CUSCINETTO A RULLI E A SFERE

130 – 260 kg

**POLYAMIDE / NYLON**

Roue Polyamide, noir ou blanc, roue à palier lisse, avec roulement à rouleaux ou à billes, non-tachant, corps/roue: Polyamide

**RÉSISTANT AUX HUILES/GRAISSES/ESSENCES...**

**POLYAMID / NYLON**

Polamid-Rad, schwarz oder weiss, Rad mit Gleitlager, Rollenlager oder Kugellager, spurfrei, Radkörper: Polamid

**BESTÄNDIGKEIT GEGEN OEL/FETT/BENZIN...**

**POLIAMMIDE / NYLON**

Ruota in Poliammide, nero e bianco, ruota a foro liscio, su cuscinetti a rulli e a sfere, antitraccia, corpo centrale: Poliammide

**RESISTENDO AGLI OLII/GRASSI/PETROLI...**

Secteurs / Bereiche / Settori



HUILE/ESSENCE  
OEL/BENZIN  
OLII/PETROLI



USINE  
FABRIK  
INDUSTRIA

Applications / Anwendung / Applicazioni



INDUSTRIE  
INDUSTRIE  
INDUSTRIA



BETON  
BETON  
CEMENTO



TAPIS  
TEPPICH  
MOQUETTE

Variantes / Varianten / Varianti



-30° - +80° C  
NYLON



ROUE  
PAGE 7.13-14  
55 – 2500 kg



SERIE 2..-3..  
PAGE 3.8  
50 – 110 kg



SERIE TL..  
PAGE 4.1-2  
80 – 600 kg



SERIE 9..-TH..  
PAGE 6.9-10  
700 – 2700 kg

AVEC PLAQUE / MIT PLATTE / A PIASTRA

AVEC TROU / MIT LOCH / A FORO

ZINGUE SERIE N° 7 'LEGER' (page 1.9)								ROUE PIVOTANTE LENKROLLE RUOTA GIREVOLE		PIVOTANT/FREIN LENKROLLE/BREMS GIREVOLE/FRENO		ROUE FIXE BOCKROLLE RUOTA FISSA		ROUE PIVOTANTE LENKROLLE RUOTA GIREVOLE		PIVOTANT/FREIN LENKROLLE/BREMS GIREVOLE/FRENO		
mm	mm	Page 1.6	kg	mm	mm	mm	mm	Art. N :	CHF sans TVA	Art. N :	CHF sans TVA	Art. N :	CHF sans TVA	mm	Art. N :	CHF sans TVA	Art. N :	CHF sans TVA
80	30		130	105x85	80x60	9	106	7161.08	13.90	---	---	7361.08	12.20	12.3	7061.08	13.90	---	---
100	33		140	105x85	80x60	9	128	7161.10	14.80	---	---	7361.10	13.10	12.3	7061.10	14.80	---	---
ZINGUE SERIE N° 5 'MEDIA' (page 1.9)																		
80	30		140	A) 105x85	75x55 85x65	9	B) 108	5161.08	16.80	5261.08	27.60	5361.08	12.50	12.3	5061.08	16.50	5761.08	27.30
80	35		180	A) 105x85	75x55 85x65	9	B) 108	5162.08	20.30	5262.08	30.70	5362.08	16.00	12.3	5062.08	19.80	5762.08	30.70
100	33		150	A) 105x85	75x55 85x65	9	B) 129	5161.10	17.90	5261.10	28.30	5361.10	13.90	12.3	5061.10	17.70	5761.10	28.10
100	30		210	A) 105x85	75x55 85x65	9	B) 129	5162.10	23.30	5262.10	33.70	5362.10	19.40	12.3	5062.10	23.10	5762.10	33.50
125	38		200	A) 105x85	75x55 85x65	9	B) 155	5161.12	22.60	5261.12	34.00	5361.12	19.00	12.3	5061.12	22.40	5761.12	33.70
125	38		210	A) 105x85	75x55 85x65	9	B) 155	5162.12	30.90	5262.12	42.20	5362.12	27.30	12.3	5062.12	30.70	5762.12	42.00
150	40		210	A) 105x85	75x55 85x65	9	B) 186	5161.15	26.40	5261.15	38.60	5361.15	22.40	12.3	5061.15	26.10	5761.15	38.30
INOX SERIE N° 7 'LEGER' (page 1.9)								INOX / ROSTFREI / INOX				INOX / ROSTFREI / INOX						
80	30		140	105x85	80x60	9	106	X-7161.08	30.10	X-7261.08	46.90	X-7361.08	24.30	12.3	X-7061.08	29.50	X-7761.08	46.60
100	33		150	105x85	80x60	9	128	X-7161.10	31.90	X-7261.10	47.70	X-7361.10	25.20	12.3	X-7061.10	30.40	X-7761.10	47.40
INOX SERIE N° 5 'MEDIA' (page 1.9)																		
80	30		150	A) 105x85	75x55 85x65	9	B) 108	X-5161.08	44.70	X-5261.08	69.00	X-5361.08	31.70	12.3	X-5061.08	42.60	X-5761.08	67.10
80	35		180	A) 105x85	75x55 85x65	9	B) 108	X-5162.08	52.30	X-5262.08	76.60	X-5362.08	39.30	12.3	X-5062.08	50.10	X-5762.08	74.10
100	33		150	A) 105x85	75x55 85x65	9	B) 129	X-5161.10	46.90	X-5261.10	72.00	X-5361.10	34.20	12.3	X-5061.10	44.50	X-5761.10	69.80
100	30		260	A) 105x85	75x55 85x65	9	B) 129	X-5162.10	53.10	X-5262.10	78.20	X-5362.10	40.30	12.3	X-5062.10	50.60	X-5762.10	76.20
125	38		200	A) 105x85	75x55 85x65	9	B) 155	X-5161.12	56.30	X-5261.12	82.80	X-5361.12	45.20	12.3	X-5061.12	53.90	X-5761.12	80.60
125	38		280	A) 105x85	75x55 85x65	9	B) 155	X-5162.12	70.40	X-5262.12	97.00	X-5362.12	59.40	12.3	X-5062.12	68.00	X-5762.12	94.80
150	40		250	A) 105x85	75x55 85x65	9	B) 186	X-5161.15	59.90	X-5261.15	88.30	X-5361.15	49.80	12.3	X-5061.15	58.20	X-5761.15	86.40

A) ROULETTE FIXE, PLAQUE / BOCKROLLE, PLATTE / RUOTA FISSA, PIASTRA: 108x87mm – 75x55 / 85x65mm  
B) ROULETTE AVEC TROU, HAUTEUR -4mm / ROLLEN MIT LOCH, BAUHÖHE -4mm / RUOTA CON FORO, ALTEZZA -4mm



**ROULETTES POUR TRANSPORTS ET INDUSTRIES**

SUPPORT EN ACIER, ZINGUÉ-PROMATISÉ  
 PIVOTEMENT SUR DOUBLE RANGÉE DE BILLES  
 ROUE À PALIER LISSE, ROULEMENT À ROULEAUX OU À BILLES

**TRANSPORT- UND INDUSTRIE-ROLLEN**

GEHÄUSE AUS STAHLBLECH, VERZINKT-PROMATISIERT  
 SCHWENKLAGER MIT ZWEIFACHEM KUGELKRANZ  
 RAD MIT GLEITLAGER, ROLLENLAGER ODER KUGELLAGER

**RUOTE PER TRASPORTO ED INDUSTRIA**

SUPPORTI IN LAMIERA D'ACCIAIO, ZINCATO-CROMATO  
 PIROETTAMENTO A DOPPIA CORONA DI SFERE  
 RUOTA A FORO LISCIO, SU CUSCINETTO A RULLI E A SFERE

230 – 450 kg

**POLYAMIDE / NYLON**

Roue Polyamide, noir ou blanc, roue à palier lisse, avec roulement à rouleaux ou à billes, non-tachant, corps/roue: Polyamide

RÉSISTANT AUX HUILES/GRAISSES/ESSENCES...

**POLYAMID / NYLON**

Polyamid-Rad, schwarz oder weiss, Rad mit Gleitlager, Rollenlager oder Kugellager, spurfrei, Radkörper: Polyamid

BESTÄNDIGKEIT GEGEN OEL/FETT/BENZIN...

**POLIAMMIDE / NYLON**

Ruota in Poliammide, nero e bianco, ruota a foro liscio, su cuscinetti a rulli e a sfere, antitraccia, corpo centrale: Poliammide

RESISTENDO AGLI OLI/GRASSI/PETROLI...

Secteurs / Bereiche / Settori



HUILE/ESSENCE  
 OEL/BENZIN  
 OLI/PETROLI



USINE  
 FABRIK  
 INDUSTRIA

Applications / Anwendung / Applicazioni



INDUSTRIE  
 INDUSTRIE  
 INDUSTRIA



BETON  
 BETON  
 CEMENTO



TAPIS  
 TEPPICH  
 MOQUETTE

Variantes / Varianten / Varianti



-30° - +80° C  
 NYLON



ROUE  
 PAGE 7.13-14  
 55 – 2500 kg



SERIE 2...3..  
 PAGE 3.8  
 50 – 110 kg



SERIE 55..  
 PAGE 4.3  
 350 – 500 kg



SERIE 9...TH..  
 PAGE 6.9-10  
 700 – 2700 kg

AVEC PLAQUE / MIT PLATTE / A PIASTRA

AVEC TROU / MIT LOCH / A FORO

								ROUE PIVOTANTE LENKROLLE RUOTA GIREVOLE		PIVOTANT/FREIN LENKROLLE/BREMS GIREVOLE/FRENO		ROUE FIXE BOCKROLLE RUOTA FISSA				ROUE PIVOTANTE LENKROLLE RUOTA GIREVOLE		PIVOTANT/FREIN LENKROLLE/BREMS GIREVOLE/FRENO	
mm	mm	Page 1.6	kg	mm	mm	mm	mm	Art. N :	CHF sans TVA	Art. N :	CHF sans TVA	Art. N :	CHF sans TVA	mm	Art. N :	CHF sans TVA	Art. N :	CHF sans TVA	
<b>ZINGUE_SERIE N° 8 'MEDIA' (page 1.9)</b>																			
160	40		230	135x110	105x80	11	195	52	8161.16	38.30	8261.16	51.60	8361.16	31.60	16.3	8061.16	38.00	8761.16	50.50
200	50		250	135x110	105x80	11	235	55	8161.20	51.60	8261.20	64.40	8361.20	45.10	16.3	8061.20	51.00	8761.20	63.30
<b>ZINGUE_SERIE N° 6 'FORT' (page 1.10)</b>																			
125	38		300	135x110	105x75-80	11	A) 164	53	6161.121	42.90	6261.121	62.90	6361.121	35.30	16.3	6061.121	42.60	6761.121	62.70
125	38		330	135x110	105x75-80	11	A) 164	53	6162.121	49.70	6262.121	69.30	6362.121	40.30	16.3	6062.121	49.30	6762.121	68.30
150	43		300	135x110	105x75-80	11	A) 193	55	6161.151	44.40	6261.151	63.70	6361.151	35.80	16.3	6061.151	45.70	6761.151	65.50
150	40		330	135x110	105x75-80	11	A) 193	55	6162.151	50.10	6262.151	70.60	6362.151	41.20	16.3	6062.151	51.60	6762.151	72.00
160	40		300	135x110	105x75-80	11	A) 199	55	6161.16	40.50	6261.16	60.10	6361.16	32.00	16.3	6061.16	42.00	6761.16	61.60
160	40		330	135x110	105x75-80	11	A) 199	55	6162.16	51.30	6262.16	71.80	6362.16	42.30	16.3	6062.16	52.90	6762.16	73.20
200	50		330	135x110	105x75-80	11	A) 237	58	6161.20	52.90	6261.20	73.10	6361.20	44.80	16.3	6061.20	53.10	6761.20	75.00
200	50		330	135x110	105x75-80	11	A) 237	58	6162.20	61.00	6262.20	82.20	6362.20	51.30	16.3	6062.20	61.00	6762.20	84.20
<b>INOX_SERIE N° 8 'MEDIA' (page 1.9)</b>																			
INOX / ROSTFREI / INOX										INOX / ROSTFREI / INOX									
160	40		260	135x110	105x80	11	195	52	X-8161.16	80.90	X-8261.16	103.70	X-8361.16	71.20	16.3	X-8061.16	81.20	X-8761.16	102.80
200	50		280	135x110	105x80	11	235	55	X-8161.20	94.40	X-8261.20	118.30	X-8361.20	87.20	16.3	X-8061.20	95.30	X-8761.20	117.30
<b>INOX_SERIE N° 6 'FORT' (page 1.10)</b>																			
INOX / ROSTFREI / INOX										INOX / ROSTFREI / INOX									
125	38		300	135x110	105x75-80	11	A) 164	53	X-6161.121	92.00	X-6261.121	139.90	X-6361.121	67.30	16.3	X-6061.121	90.90	X-6761.121	138.90
150	40		300	135x110	105x75-80	11	A) 193	55	X-6161.151	108.20	X-6261.151	160.80	X-6361.151	85.00	16.3	X-6061.151	108.60	X-6761.151	160.00
160	40		300	135x110	105x75-80	11	A) 199	55	X-6161.16	104.70	X-6261.16	157.20	X-6361.16	81.50	16.3	X-6061.16	104.90	X-6761.16	156.10
160	40		400	135x110	105x75-80	11	A) 199	55	X-6162.16	115.60	X-6262.16	168.10	X-6362.16	92.40	16.3	X-6062.16	115.80	X-6762.16	166.90
200	50		400	135x110	105x75-80	11	A) 237	58	X-6161.20	118.70	X-6261.20	176.20	X-6361.20	99.00	16.3	X-6061.20	117.90	X-6761.20	175.30
200	50		450	135x110	105x75-80	11	A) 237	58	X-6162.20	126.90	X-6262.20	182.30	X-6362.20	105.80	16.3	X-6062.20	125.90	X-6762.20	183.10

A) ROULETTE AVEC TROU, HAUTEUR -6mm / ROLLEN MIT LOCH, BAUHÖHE -6mm / RUOTA CON FORO, ALTEZZA -6mm

**RABAIS / RABATT / SCONTO : 20% dès/ab/da 100.-- (CHF) / 25% dès/ab/da 500.-- (CHF)**  
 RABAIS DE QUANTITE SUR DEMANDE ! MENGENRABATT AUF ANFRAGE ! SCONTO DI QUANTITA SU RICHIESTA !

**ROULETTES POUR TRANSPORTS ET INDUSTRIES**

SUPPORT EN ACIER, ZINGUÉ-PROMATISÉ  
PIVOTEMENT SUR DOUBLE RANGÉE DE BILLES  
ROUE À PALIER LISSE, ROULEMENT À ROULEAUX OU À BILLES

**TRANSPORT- UND INDUSTRIE-ROLLEN**

GEHÄUSE AUS STAHLBLECH, VERZINKT-PROMATISIERT  
SCHWENKLAGER MIT ZWEIFACHEM KUGELKRANZ  
RAD MIT GLEITLAGER, ROLLENLAGER ODER KUGELLAGER

**RUOTE PER TRASPORTO ED INDUSTRIE**

SUPPORTI IN LAMIERA D'ACCIAIO, ZINCATO-CROMATO  
PIROETTAMENTO A DOPPIA CORONA DI SFERE  
RUOTA A FORO LISCIO, SU CUSCINETTO A RULLI E A SFERE

**230 – 480 kg**

**POLYAMIDE / NYLON 6**

Roue Polyamide/Nylon 6, gris, roue avec roulement à rouleaux ou à billes, non-tachant, corps/roue: Nylon 6 renforcé de fibres de verre  
**RÉSISTANT AUX HUILES/GRAISSES/ESSENCES...**

**POLYAMID / NYLON 6**

Polyamid-Rad/Nylon 6, grau, Rad mit Rollenlager oder Kugellager, spurfrei, Radkörper: Nylon 6 und Glasfaser Verbindung  
**BESTÄNDIGKEIT GEGEN OEL/FETT/BENZIN...**

**POLIAMMIDE / NYLON 6**

Ruota in Poliammide/Nylon 6, grigia, ruota su cuscinetti a rulli e a sfere, antitraccia, corpo centrale: Nylon 6 rinforzato con fibra di vetro  
**RESISTENDO AGLI OLII/GRASSI/PETROLI...**

**Secteurs / Bereiche / Settori**



HUILE/ESSENCE  
OEL/BENZIN  
OLII/PETROLI



USINE  
FABRIK  
INDUSTRIA

**Applications / Anwendung / Applicazioni**



INDUSTRIE  
INDUSTRIE  
INDUSTRIA



BETON  
BETON  
CEMENTO



TAPIS  
TEPPICH  
MOQUETTE

**Variantes / Varianten / Varianti**



-30° - +80° C  
NYLON



**ROUE**  
PAGE 7.14  
300 – 2500 kg



**SERIE 34..-**  
PAGE 4.2  
180 – 650 kg



**SERIE 55..-**  
PAGE 4.3  
350 – 500 kg



**SERIE 9..-TH..**  
PAGE 6.9-10  
700 – 2700 kg

**AVEC PLAQUE / MIT PLATTE / A PIASTRA**

**AVEC TROU / MIT LOCH / A FORO**

								ROUE PIVOTANTE LENKROLLE RUOTA GIREVOLE		PIVOTANT/FREIN LENKROLLE/BREMS GIREVOLE/FRENO		ROUE FIXE BOCKROLLE RUOTA FISSA				ROUE PIVOTANTE LENKROLLE RUOTA GIREVOLE		PIVOTANT/FREIN LENKROLLE/BREMS GIREVOLE/FRENO	
mm	mm	Page 1.6	kg	mm	mm	mm	mm	Art. N :	CHF sans TVA	Art. N :	CHF sans TVA	Art. N :	CHF sans TVA	mm	Art. N :	CHF sans TVA	Art. N :	CHF sans TVA	
<b>ZINGUE_SERIE N° 8 'MEDIA' (page 1.9)</b>																			
160	46		230	135x110	105x80	11	195	8166.16	71.00	8266.16	85.80	8366.16	65.10	16.3	8066.16	71.90	8766.16	84.90	
200	50		250	135x110	105x80	11	235	8166.20	85.60	8266.20	100.10	8366.20	79.00	16.3	8066.20	85.20	8766.20	99.20	
<b>ZINGUE_SERIE N° 6 'FORT' (page 1.10)</b>																			
125	46		350	135x110	105x75-80	11	<sup>B)</sup> 164	6166.12	68.50	6266.12	86.80	6366.12	59.00	16.3	6066.12	67.30	6766.12	87.50	
160	46		360	135x110	105x75-80	11	<sup>B)</sup> 199	6166.16	77.10	6266.16	95.40	6366.16	67.30	16.3	6066.16	77.40	6766.16	97.20	
200	50		360	135x110	105x75-80	11	<sup>B)</sup> 237	6166.20	88.60	6266.20	109.60	6366.20	80.90	16.3	6066.20	90.70	6766.20	111.80	
250	60		395	200x160	140x110 160x120	14	<sup>B)</sup> 300	6162.25	182.90	6262.25	210.10	6362.25	146.70	---	---	---	---	---	
250	60		400	200x160	140x110 160x120	14	<sup>B)</sup> 300	6163.25	193.20	6263.25	220.40	6363.25	157.00	---	---	---	---	---	
<b>INOX_SERIE N° 8 'MEDIA' (page 1.9)</b>																			
<b>INOX / ROSTFREI / INOX (2RS)</b>																			
<sup>A)</sup> 160	46		260	135x110	105x80	11	195	X-8166.16	123.30	X-8266.16	147.10	X-8366.16	111.00	16.3	X-8066.16	121.10	X-8766.16	142.50	
<sup>A)</sup> 200	50		280	135x110	105x80	11	235	X-8166.20	139.00	X-8266.20	161.50	X-8366.20	126.40	16.3	X-8066.20	135.60	X-8766.20	157.90	
<b>INOX_SERIE N° 6 'FORT' (page 1.10)</b>																			
<b>INOX / ROSTFREI / INOX (2RS)</b>																			
<sup>A)</sup> 125	46		470	135x110	105x75-80	11	<sup>B)</sup> 164	X-6166.12	136.40	X-6266.12	187.00	X-6366.12	113.10	16.3	X-6066.12	134.20	X-6766.12	186.10	
<sup>A)</sup> 160	46		480	135x110	105x75-80	11	<sup>B)</sup> 199	X-6166.16	145.80	X-6266.16	196.40	X-6366.16	121.70	16.3	X-6066.16	145.00	X-6766.16	195.70	
<sup>A)</sup> 200	50		480	135x110	105x75-80	11	<sup>B)</sup> 237	X-6166.20	158.80	X-6266.20	215.80	X-6366.20	139.70	16.3	X-6066.20	159.60	X-6766.20	215.20	

A) EGALEMENT AVEC ROULEMENT A BILLES EN INOX +CHF 16.00 / AUCH MIT KUGELLAGER AUS ROSTFREI +CHF 16.00 / ANCHE CON CUSCINETTO A SFERE IN INOX +CHF 16.00  
B) ROULETTE AVEC TROU, HAUTEUR -6mm / ROLLEN MIT LOCH, BAUHÖHE -6mm / RUOTA CON FORO, ALTEZZA -6mm

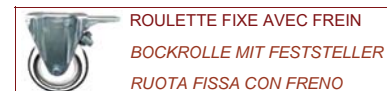

**ROULETTES POUR TRANSPORTS ET INDUSTRIES**

SUPPORT EN ACIER, ZINGUÉ-PROMATISÉ  
PIVOTEMENT SUR DOUBLE RANGÉE DE BILLES  
ROUE À PALIER LISSE, ROULEMENT À ROULEAUX OU À BILLES

**TRANSPORT- UND INDUSTRIE-ROLLEN**

GEHÄUSE AUS STAHLBLECH, VERZINKT-PROMATISIERT  
SCHWENKLAGER MIT ZWEIFACHEM KUGELKRANZ  
RAD MIT GLEITLAGER, ROLLENLAGER ODER KUGELLAGER

**RUOTE PER TRASPORTO ED INDUSTRIA**

SUPPORTI IN LAMIERA D'ACCIAIO, ZINCATO-CROMATO  
PIROETTAMENTO A DOPPIA CORONA DI SFERE  
RUOTA A FORO LISCIO, SU CUSCINETTO A RULLI E A SFERE

60 – 250 kg

**ROUE CHALEUR**

Roue en Résine de Phénol, noir, roue à palier lisse,  
non-tachant, corps/roue: Résine de Phénol

RECOMMANDÉ POUR LES BOULANGERIES ET L'INDUSTRIE

**HITZEBESTÄNDIG**

Rad aus Phenolharz, schwarz, Rad mit Gleitlager,  
spurfrei, Radkörper: Phenolharz

EMPFOHLEN FÜR BÄCKEREI UND INDUSTRIE

**ALTE TEMPERATURE**

Ruota in Resina Fenolica, nero, ruota a foro liscio,  
antitraccia, corpo centrale: Resina Fenolica

RACCOMANDATÒ PER PANETTERIE ED INDUSTRIA

Secteurs / Bereiche / Settori



USINE  
FABRIK  
INDUSTRIA



CUISINE  
KÜCHE  
CUCINA

Applications / Anwendung / Applicazioni



CHALEUR  
HITZEBESTÄNDIG  
ALTE TEMPERAT.



INDUSTRIE  
INDUSTRIE  
INDUSTRIA



BETON  
BETON  
CEMENTO

Variantes / Varianten / Varianti



-40° - +280° C  
95 Sh/A



ROUE  
PAGE 7.12  
200 – 500 kg



ROUE \*D)  
PAGE 7.12  
60 – 80 kg

AVEC PLAQUE / MIT PLATTE / A PIASTRA

AVEC TROU / MIT LOCH / A FORO

										ROUE PIVOTANTE LENKROLLE RUOTA GIREVOLE		PIVOTANT/FREIN LENKROLLE/BREMS GIREVOLE/FRENO		ROUE FIXE BOCKROLLE RUOTA FISSA				ROUE PIVOTANTE LENKROLLE RUOTA GIREVOLE		PIVOTANT/FREIN LENKROLLE/BREMS GIREVOLE/FRENO	
										Art. N :	CHF sans TVA	Art. N :	CHF sans TVA	Art. N :	CHF sans TVA	mm	Art. N :	CHF sans TVA	Art. N :	CHF sans TVA	
<b>ZINGUE_SERIE N° 5 'MEDIA' (page 1.9)</b>																					
80	35		200	A) 105x85	75x55 85x65	9	B) 108	38		5169.08	36.40	5269.08	48.30	5369.08	31.60	12.3	5069.08	36.10	5769.08	48.00	
100	35		210	A) 105x85	75x55 85x65	9	B) 129	33		5169.10	41.00	5269.10	52.90	5369.10	36.40	12.3	5069.10	40.50	5769.10	52.50	
125	40		210	A) 105x85	75x55 85x65	9	B) 155	35		5169.12	65.10	5269.12	78.30	5369.12	61.20	12.3	5069.12	65.10	5769.12	78.00	
D) 100	30		60	A) 105x85	75x55 85x65	9		129 33		5169.10-S	83.40	5269.10-S	97.70	5369.10-S	74.30	12.3	5069.10-S	82.40	5769.10-S	96.90	
<b>ZINGUE_SERIE N° 6 'FORT' (page 1.10)</b>																					
125	40		300	135x110	105x 75-80	11	C) 164	53		6169.12	76.40	6269.12	96.40	6369.12	66.40	16.3	6069.12	78.00	6769.12	96.90	
150	50		360	135x110	105x 75-80	11	C) 193	55		6169.15	140.10	6269.15	159.20	6369.15	129.60	16.3	6069.15	140.40	6769.15	161.20	
200	50		360	135x110	105x 75-80	11	C) 237	58		6169.20	169.50	6269.20	189.80	6369.20	159.60	16.3	6069.20	169.80	6769.20	193.20	
<b>INOX_SERIE N° 5 'MEDIA' (page 1.9)</b>										<b>INOX / ROSTFREI / INOX</b>						<b>INOX / ROSTFREI / INOX</b>					
80	35		200	A) 105x85	75x55 85x65	9	B) 108	38		X-5169.08	59.20	X-5269.08	82.80	X-5369.08	46.40	12.3	X-5069.08	57.20	X-5769.08	81.20	
100	35		250	A) 105x85	75x55 85x65	9	B) 129	33		X-5169.10	63.60	X-5269.10	89.30	X-5369.10	51.40	12.3	X-5069.10	61.70	X-5769.10	87.20	
125	40		280	A) 105x85	75x55 85x65	9	B) 155	35		X-5169.12	89.30	X-5269.12	116.00	X-5369.12	78.20	12.3	X-5069.12	86.90	X-5769.12	114.00	
D) 100	30		60	A) 105x85	75x55 85x65	9		129 33		X-5169.10-S	106.30	X-5269.10-S	132.20	X-5369.10-S	89.00	12.3	X-5069.10-S	104.70	X-5769.10-S	131.20	
<b>INOX_SERIE N° 6 'FORT' (page 1.10)</b>										<b>INOX / ROSTFREI / INOX</b>						<b>INOX / ROSTFREI / INOX</b>					
125	40		300	135x110	105x 75-80	11	C) 164	53		X-6169.12	120.40	X-6269.12	169.10	X-6369.12	96.90	16.3	X-6069.12	119.60	X-6769.12	168.30	
150	50		400	135x110	105x 75-80	11	C) 193	55		X-6169.15	188.60	X-6269.15	239.20	X-6369.15	164.20	16.3	X-6069.15	187.80	X-6769.15	238.40	
200	50		480	135x110	105x 75-80	11	C) 237	58		X-6169.20	216.70	X-6269.20	272.70	X-6369.20	195.90	16.3	X-6069.20	215.80	X-6769.20	272.40	

- A) ROULETTE FIXE, PLAQUE / BOCKROLLE, PLATTE / RUOTA FISSA, PIASTRA: 108x87mm – 75x55 / 85x65mm
- B) ROULETTE AVEC TROU, HAUTEUR -4mm / ROLLEN MIT LOCH, BAUHÖHE -4mm / RUOTA CON FORO, ALTEZZA -4mm
- C) ROULETTE AVEC TROU, HAUTEUR -6mm / ROLLEN MIT LOCH, BAUHÖHE -6mm / RUOTA CON FORO, ALTEZZA -6mm
- D) CAOUTCHOUC-ELASTIQUE ROUGE (80 Sh/A, SILENCIEUX) / ELASTISCH-GUMMI ROT (80 Sh/A, LAUFRUHE) / GOMMA-ELASTICA (80 Sh/A, SILENCIA)



**RABAIS / RABATT / SCONTO : 20% dès/ab/da 100.-- (CHF) / 25% dès/ab/da 500.-- (CHF)**  
RABAIS DE QUANTITE SUR DEMANDE ! MENGENRABATT AUF ANFRAGE ! SCONTO DI QUANTITA SU RICHIESTA !



**ROULETTES POUR TRANSPORTS ET INDUSTRIES**

SUPPORT EN ACIER, ZINGUÉ-PROMATISÉ  
PIVOTEMENT SUR DOUBLE RANGÉE DE BILLES  
ROUE À PALIER LISSE, ROULEMENT À ROULEAUX OU À BILLES

**TRANSPORT- UND INDUSTRIE-ROLLEN**

GEHÄUSE AUS STAHLBLECH, VERZINKT-PROMATISIERT  
SCHWENKLAGER MIT ZWEIFACHEM KUGELKRANZ  
RAD MIT GLEITLAGER, ROLLENLAGER ODER KUGELLAGER

**RUOTE PER TRASPORTO ED INDUSTRIE**

SUPPORTI IN LAMIERA D'ACCIAIO, ZINCATO-CROMATO  
PIROETTAMENTO A DOPPIA CORONA DI SFERE  
RUOTA A FORO LISCIO, SU CUSCINETTO A RULLI E A SFERE

>> PAGE / SEITE / PAGINA >2.9 + 3.13 + 4.7 + 5.21

**RABAIS SPÉCIAL 30%**  
SET-CONTAINER (4 pces, au choix)

**SPEZIAL-RABATT 30%**  
SET-CONTAINER (4 Stk, nach wahl)

**SCONTO SPECIALE 30%**  
SET-CASSONETTI (4 pz, a scelta)

A  
C  
T  
I  
O  
N



**ROUES POUR CONTAINER**  
**RÄDER FÜR CONTAINER**  
**RUOTE PER CASSONETTI**

ZINGUE_SERIE N° 6 'FORT' (page 1.10)										ROUE PIVOTANTE LENKROLLE RUOTA GIREVOLE		PIVOTANT/FREIN LENKROLLE/BREMS GIREVOLE/FRENO		+FREIN DIRECTION +RICHTUNG-BREMS +DIREZIONAL-FRENO		ROUE RÄDER RUOTA			
mm	mm	Page 1.6	kg	mm	mm	mm	mm	mm	mm	Art. N :	Prix Preis Prezzo CHF sans TVA	Art. N :	Prix Preis Prezzo CHF sans TVA	Art. N :	Prix Preis Prezzo CHF sans TVA	mm	mm	Art. N :	Prix Preis Prezzo CHF sans TVA
180	45		180	135x110	105x75/80	11	A)	229	58	6142.18	48.80	6242.18	67.20	BR/6142.18	63.40	60	20	42.18	25.20
200	45		210	135x110	105x75/80	11	A)	237	58	6142.20	52.20	6242.20	72.20	BR/6142.20	68.40	60	20	42.20	27.60

A) ROULETTE AVEC TROU, HAUTEUR -6mm / ROLLEN MIT LOCH, BAUHÖHE -6mm / RUOTA CON FORO, ALTEZZA -6mm

AUTRES GRANDEURS DISPONIBLES, page 5.1-19, 7.1-14 / ANDERE VERFÜGBAREN GRÖßEN, Seite 5.1-19, 7.1-14 / ALTRE DIMENSIONI DISPONIBILI, pagina 5.1-19, 7.1-14

>> PAGE / SEITE / PAGINA >2.9 + 3.13 + 4.7 + 5.21

**RABAIS SPÉCIAL 30%**  
SET-'FLIGHT-CASES' (4 pces, au choix)

**SPEZIAL-RABATT 30%**  
SET-'FLIGHT-CASES' (4 Stk, nach wahl)

**SCONTO SPECIALE 30%**  
SET-'FLIGHT-CASES' (4 pz, a scelta)

A  
C  
T  
I  
O  
N



**ROUES POUR FLIGHT-CASES**  
**RÄDER FÜR FLIGHT-CASES**  
**RUOTE PER FLIGHT-CASES**

ZINGUE_SERIE N° 5 'MEDIA' (page 1.9)										ROUE PIVOTANTE LENKROLLE RUOTA GIREVOLE		PIVOTANT/FREIN LENKROLLE/BREMS GIREVOLE/FRENO		ROUE FIXE BOCKROLLE RUOTA FISSA		ROUE RÄDER RUOTA			
mm	mm	Page 1.6	kg	mm	mm	mm	mm	mm	mm	Art. N :	Prix Preis Prezzo CHF sans TVA	Art. N :	Prix Preis Prezzo CHF sans TVA	Art. N :	Prix Preis Prezzo CHF sans TVA	mm	mm	Art. N :	Prix Preis Prezzo CHF sans TVA
80	30		140	105x85	75x55 85x65	9	A)	108	33	5132.08	38.90	5232.08	50.10	5332.08	34.40	40	12	32.08	29.30
100	32		200	105x85	75x55 85x65	9	A)	129	33	5132.10	32.00	5232.10	43.00	5332.10	28.00	40	12	32.10	18.90
125	40		210	105x85	75x55 85x65	9	A)	155	35	5132.12	42.80	5232.12	54.70	5332.12	38.90	50	15	32.12	26.70

A) ROULETTE AVEC TROU, HAUTEUR -4mm / ROLLEN MIT LOCH, BAUHÖHE -4mm / RUOTA CON FORO, ALTEZZA -4mm

AUTRES GRANDEURS DISPONIBLES, page 5.1-7, 7.1-5 / ANDERE VERFÜGBAREN GRÖßEN, Seite 5.1-7, 7.1-5 / ALTRE DIMENSIONI DISPONIBILI, pagina 5.1-7, 7.1-5





**ROULETTES POUR INDUSTRIES**

**INDUSTRIE-ROLLEN**

**RUOTE PER INDUSTRIA**

# 6



**280 – 6'500 kg**



**125 - 300 mm**

**INDEX / INHALT / INDICE**



**PAGE 6.1**  
CAOUTCH-ELAST  
GUMMI-ELAST  
GOMMA-ELAST



**PAGE 6.2**  
CAOUTCH-ELAST  
GUMMI-ELAST  
GOMMA-ELAST



**PAGE 6.3**  
POLYURETHANE  
POLYURETHAN  
POLIURETANO



**PAGE 6.4**  
ANTISTATIQUE  
ANTISTATISCH  
ANTISTATICO



**PAGE 6.5**  
POLYURETHANE  
POLYURETHAN  
POLIURETANO



**PAGE 6.6**  
POLYURETHANE  
POLYURETHAN  
POLIURETANO



**PAGE 6.7-8**  
POLYURETHANE  
POLYURETHAN  
POLIURETANO



**PAGE 6.9**  
NYLON 6  
NYLON 6  
NYLON 6



**PAGE 6.10**  
NYLON 6  
NYLON 6  
NYLON 6



**PAGE 6.11**  
FONTE  
GUSS  
GHISA

**SECTEURS / BEREICHE / SETTORI**



**WEMAS Sàrl - CH-2720 TRAMELAN**

ROUES-ROULETTES / RÄDER-ROLLEN / RUOTE-ROTELLE / WHEELS-CASTORS

TELEPHONE **032 487 43 28** / FAX **032 487 44 43**

INTERNET **www.wemas.ch** / E-MAIL **info@wemas.ch**



**ROULETTES D'INDUSTRIES A CHARGES ELEVEES**

SUPPORT EN ACIER, INDEFORMABLE, PROMAT-ZINGUÉ  
LARGE PALIER DE PIVOTEMENT EN ACIER TREMPÉ RENFORCÉ  
ROUE A PALIER LISSE, ROULEMENT A ROULEAUX OU A BILLES

**SCHWERLASTROLLEN FÜR INDUSTRIE**

GEHÄUSE AUS STAHL, VERSCHLEISSFEST, PROMAT-VERZ.  
BREITES SCHWENKLAGER AUS GEHÄRTETEM STAHL  
RAD MIT GLEITLAGER, ROLLENLAGER ODER KUGELLAGER

**RUOTE PER INDUSTRIE A CARICHI GRAVOSI**

SUPPORTI IN LAMIERA D'ACCIAIO, INALTERABILE, ZINCATO  
GRANDE PIROETTAMENTO SU PISTE D'ACCIAIO TEMPERATO  
RUOTA A FORO LISCIO, SU CUSCINETTO A RULLI E A SFERE

**280 – 850 kg****CAOUTCHOUC SUPER-ÉLASTIQUE**

Roue Caoutchouc Super-Elastique, noir, roue avec roulement à billes, silencieux, extra-souple, corps/roue: jante Alu

**LE CAOUTCHOUC NOIR PEUT LAISSER DES TRACES AU SOL !!**

**ELASTISCH-GUMMI**

Elastisches Vollgummirad, schwarz, Rad mit Kugellager, Laufruhe, extra-weich, Radkörper: Alu-Felge

**SCHWARZGUMMI IST NICHT SPURFREI !!**

**GOMMA-ELASTICA**

Ruota in Gomma Elastica, nero, ruota su cuscinetti a sfere, silenziosa, grande elasticità, corpo centrale: Alluminio

**LA GOMMA NERA PUÒ SEGNARE IL SUOLO !!**

**Secteurs / Bereiche / Settori**

MANUTENTION  
TRANSPORT  
TRASPORTO

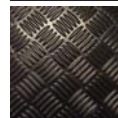

TRANSPALETTE  
PALETTENWAGEN  
TRANSPALETTE

**Applications / Anwendung / Applicazioni**

SOL ACIER  
STAHL  
ACCIAIO



PAVE  
PFLASTER-STEIN  
PAVIMENTO



GOUDRON  
ASPHALT  
ASFALTO

**Variantes / Varianten / Varianti**

-20° - +80° C  
70 Sh/A



**ROUE**  
PAGE 7.5  
200 – 495 kg



**SERIE 55..**  
PAGE 4.3  
210 – 450 kg



**SERIE 5..-8..**  
PAGE 5.6  
200 – 450 kg

**AVEC PLAQUE / MIT PLATTE / A PIASTRA**

										ROUE PIVOTANTE LENKROLLE RUOTA GIREVOLE		PIVOTANT/FREIN LENKROLLE/BREMS GIREVOLE/FRENO		ROUE FIXE BOCKROLLE RUOTA FISSA	
										Prix Preis Prezzo		Prix Preis Prezzo		Prix Preis Prezzo	
										Art. N :	CHF sans TVA	Art. N :	CHF sans TVA	Art. N :	CHF sans TVA
<b>ZINGUE_SERIE N° 9 'EXTRA' (page 1.11)</b>															
<b>125</b>	50		<b>300</b>	140x110	105x80	12.5	176	45		<b>9153.12</b>	107.00	<b>9253.12</b>	136.20	<b>9353.12</b>	82.30
<b>160</b>	50		<b>350</b>	140x110	105x80	12.5	210	52		<b>9153.16</b>	110.70	<b>9253.16</b>	140.40	<b>9353.16</b>	87.70
<b>180</b>	50		<b>390</b>	140x110	105x80	12.5	230	58		<b>9153.18</b>	124.20	<b>9253.18</b>	152.70	<b>9353.18</b>	102.50
<b>200</b>	50		<b>450</b>	140x110	105x80	12.5	250	58		<b>9153.20</b>	128.20	<b>9253.20</b>	156.40	<b>9353.20</b>	106.60
<b>250</b>	50		<b>495</b>	200x160	160x120	14.5	325	85		<b>9153.25</b>	303.30	<b>9253.25</b>	347.90	<b>9353.25</b>	220.50
<b>INOX_SERIE N° 9 'EXTRA' (page 1.11)</b>										<b>INOX / ROSTFREI / INOX (2RS)</b>					
A) <b>125</b>	50		<b>280</b>	140x110	105x80	12.5	176	45		<b>X-9153.12</b>	265.90	<b>X-9253.12</b>	329.80	<b>X-9353.12</b>	240.10
A) <b>160</b>	50		<b>350</b>	140x110	105x80	12.5	210	52		<b>X-9153.16</b>	274.60	<b>X-9253.16</b>	338.40	<b>X-9353.16</b>	249.80
A) <b>180</b>	50		<b>390</b>	140x110	105x80	12.5	230	58		<b>X-9153.18</b>	303.90	<b>X-9253.18</b>	366.10	<b>X-9353.18</b>	281.70
A) <b>200</b>	50		<b>450</b>	140x110	105x80	12.5	250	58		<b>X-9153.20</b>	301.10	<b>X-9253.20</b>	363.30	<b>X-9353.20</b>	278.90

A) EGALEMENT AVEC ROULEMENT A BILLES EN INOX +CHF 16.00 / AUCH MIT KUGELLAGER AUS ROSTFREI +CHF 16.00 / ANCHE CON CUSCINETTO A SFERE IN INOX +CHF 16.00

**ROULETTE JUMELÉE / ZWILLING-LENKROLLE / ROTELLE-GEMELLATA**

										ROUE PIVOTANTE LENKROLLE RUOTA GIREVOLE		PIVOTANT/FREIN LENKROLLE/BREMS GIREVOLE/FRENO		ROUE FIXE BOCKROLLE RUOTA FISSA	
										Prix Preis Prezzo		Prix Preis Prezzo		Prix Preis Prezzo	
										Art. N :	CHF sans TVA	Art. N :	CHF sans TVA	Art. N :	CHF sans TVA
<b>ZINGUE_SERIE N° TH/TW 'EXTRA' (page 1.11)</b>															
<b>125</b>	2x50		<b>500</b>	A) 150x110 120x60 105x80	12.5	178	45			<b>TH/TW 53.12</b>	306.00	<i>sur demande auf Anfrage</i>		<b>THR/TW 53.12</b>	219.90
<b>160</b>	2x50		<b>650</b>	A) 150x110 120x60 105x80	12.5	208	50			<b>TH/TW 53.16</b>	318.60	<i>sur demande auf Anfrage</i>		<b>THR/TW 53.16</b>	229.00
<b>200</b>	2x50		<b>850</b>	A) 150x110 120x60 105x80	12.5	252	55			<b>TH/TW 53.20</b>	352.80	<i>sur demande auf Anfrage</i>		<b>THR/TW 53.20</b>	265.30

A) ROULETTE FIXE, PLAQUE 175x150mm / BOCKROLLE, PLATTE 175x150mm / RUOTA FISSA, PIASTRA 175x150mm





**ROULETTES D'INDUSTRIES A CHARGES ELEVÉES**

SUPPORT EN ACIER, INDÉFORMABLE, PROMAT-ZINGUÉ  
LARGE PALIER DE PIVOTEMENT EN ACIER TREMPÉ RENFORCÉ  
ROUE A PALIER LISSE, ROULEMENT A ROULEAUX OU A BILLES

**SCHWERLASTROLLEN FÜR INDUSTRIE**

GEHÄUSE AUS STAHL, VERSCHLEISSFEST, PROMAT-VERZ.  
BREITES SCHWENKLAGER AUS GEHÄRTETEM STAHL  
RAD MIT GLEITLAGER, ROLLENLAGER ODER KUGELLAGER

**RUOTE PER INDUSTRIA A CARICHI GRAVOSI**

SUPPORTI IN LAMIERA D'ACCIAIO, INALTERABILE, ZINCATO  
GRANDE PIROETTAMENTO SU PISTE D'ACCIAIO TEMPERATO  
RUOTA A FORO LISCIO, SU CUSCINETTO A RULLI E A SFERE

**350 – 850 kg****CAOUTCHOUC SUPER-ÉLASTIQUE**

Roue Caoutchouc Super-Elastique, bleu/gris, roue avec roulement à rouleaux ou à billes, silencieux, non-tachant, extra-souple, corps/roue: Nylon 6

RECOMMANDÉ POUR LES HALLES POLYVALENTES ET L'ALIMENTATION

**ELASTISCH-GUMMI**

Elastisches Vollgummirad, blau/grau, Rad mit Rollenlager oder Kugellager, Laufrolle, spurfrei, extra-weich, Radkörper: Nylon 6

EMPFOHLEN FÜR MEHRZWECKHALLEN UND LEBENSMITTEL

**GOMMA-ELASTICA**

Ruota in Gomma Elastica, blu/grigia, ruota su cuscinetti a rulli e a sfere, silenziosa, antitraccia, grande elasticità, corpo centrale: Nylon 6

RACCOMANDATÒ PER LE CENTRO SPORTIVA ED L'ALIMENTAZIONE

**Secteurs / Bereiche / Settori**

SALLE DE SPORT  
SPORTHALLE  
CENTR. SPORTI

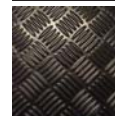

CUISINE  
KÜCHE  
CUCINA

**Applications / Anwendung / Applicazioni**

SOL ACIER  
STAHL  
ACCIAIO



PAVE  
PFLASTER-STEIN  
PAVIMENTO

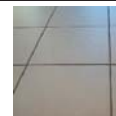

CARRELAGE  
FLIESEN  
PIASTRELLE

**Variantes / Varianten / Varianti**

-20° - +80° C  
70 Sh/A













ROUE  
PAGE 7.5  
140 - 480 kg









SERIE 5...8..  
PAGE 5.7-8  
120 - 450 kg

**AVEC PLAQUE / MIT PLATTE / A PIASTRA**

								ROUE PIVOTANTE LENKROLLE RUOTA GIREVOLE	Pivotant/Frein LENKROLLE/BREMS GIREVOLE/FRENO		ROUE FIXE BOCKROLLE RUOTA FISSA			
														
								Prix Preis Prezzo	Prix Preis Prezzo		Prix Preis Prezzo			
mm	mm	Page 1.6	kg	mm	mm	mm	mm	Art. N :	CHF sans TVA	Art. N :	CHF sans TVA	Art. N :	CHF sans TVA	
<b>ZINGUE_SERIE N° 9 'EXTRA' (page 1.11)</b>														
160	50		350	140x110	105x80	12.5	210	52	9132.16	102.80	9232.16	131.50	9332.16	78.40
200	50		420	140x110	105x80	12.5	250	58	9132.20	115.80	9232.20	145.60	9332.20	93.90
200	50		450	140x110	105x80	12.5	250	58	9133.20	123.60	9233.20	151.90	9333.20	101.80
250	50		480	200x160	160x120	14.5	325	85	9133.25	288.40	9233.25	329.20	9333.25	204.80
<b>INOX_SERIE N° 9 'EXTRA' (page 1.11)</b>														
<b>INOX / ROSTFREI / INOX (2RS)</b>														
160	50		350	140x110	105x80	12.5	210	52	X-9132.16	271.80	X-9232.16	335.60	X-9332.16	248.30
200	50		420	140x110	105x80	12.5	250	58	X-9132.20	290.20	X-9232.20	352.80	X-9332.20	268.10
A) 200	50		450	140x110	105x80	12.5	250	58	X-9133.20	296.10	X-9233.20	358.40	X-9333.20	273.80

A) EGALEMENT AVEC ROULEMENT A BILLES EN INOX +CHF 16.00 / AUCH MIT KUGELLAGER AUS ROSTFREI +CHF 16.00 / ANCHE CON CUSCINETTO A SFERE IN INOX +CHF 16.00

**ROULETTE JUMELÉE / ZWILLING-LENKROLLE / ROTELLE-GEMELLATA**

								ROUE PIVOTANTE LENKROLLE RUOTA GIREVOLE	Pivotant/Frein LENKROLLE/BREMS GIREVOLE/FRENO		ROUE FIXE BOCKROLLE RUOTA FISSA			
														
								Prix Preis Prezzo	Prix Preis Prezzo		Prix Preis Prezzo			
mm	mm	Page 1.6	kg	mm	mm	mm	mm	Art. N :	CHF sans TVA	Art. N :	CHF sans TVA	Art. N :	CHF sans TVA	
<b>ZINGUE_SERIE N° TH/TW 'EXTRA' (page 1.11)</b>														
160	2x50		650	A) 150x110	120x60 105x80	12.5	208	50	TH/TW 32.16	299.60	sur demande auf Anfrage		THR/TW 32.16	209.60
200	2x50		780	A) 150x110	120x60 105x80	12.5	252	55	TH/TW 32.20	328.40	sur demande auf Anfrage		THR/TW 32.20	238.60
200	2x50		850	A) 150x110	120x60 105x80	12.5	252	55	TH/TW 33.20	342.90	sur demande auf Anfrage		THR/TW 33.20	255.20

A) ROULETTE FIXE, PLAQUE 175x150mm / BOCKROLLE, PLATTE 175x150mm / RUOTA FISSA, PIASTRA 175x150mm



**RABAIS / RABATT / SCONTO : 20% dès/ab/da 100.-- (CHF) / 25% dès/ab/da 500.-- (CHF)**  
RABAIS DE QUANTITE SUR DEMANDE ! MENGENRABATT AUF ANFRAGE ! SCONTO DI QUANTITA SU RICHIESTA !

**ROULETTES D'INDUSTRIES A CHARGES ELEVEES**

SUPPORT EN ACIER, INDÉFORMABLE, PROMAT-ZINGUÉ  
LARGE PALIER DE PIVOTEMENT EN ACIER TREMPÉ RENFORCÉ  
ROUE A PALIER LISSE, ROUEMENT A ROULEAUX OU A BILLES

**SCHWERLASTROLLEN FÜR INDUSTRIE**

GEHÄUSE AUS STAHL, VERSCHLEISSFEST, PROMAT-VERZ.  
BREITES SCHWENKLAGER AUS GEHÄRTETEM STAHL  
RAD MIT GLEITLAGER, ROLLENLAGER ODER KUGELLAGER

**RUOTE PER INDUSTRIE A CARICHI GRAVOSI**

SUPPORTI IN LAMIERA D'ACCIAIO, INALTERABILE, ZINCATO  
GRANDE PIROETTAMENTO SU PISTE D'ACCIAIO TEMPERATO  
RUOTA A FORO LISCIO, SU CUSCINETTO A RULLI E A SFERE

**390 – 950 kg****POLYURÉTHANE**

Roue Polyuréthane injecté, gris, roue avec roulement à billes,  
non-tachant, silencieux, corps/roue: Nylon renforcé de fibres de verre  
**RÉSISTANT AUX HUILES/GRAISSES/ESSENCES...**

**POLYURETHAN**

Rad mit Spritzguss-Polyurethan, grau, Rad mit Kugellager,  
spurfrei, Laufruhe, Radkörper: Nylon und Glasfaser Verbindung  
**BESTÄNDIGKEIT GEGEN OEL/FETT/BENZIN...**

**POLIURETANO**

Ruota rivestimento in Poliuretano iniettato, grigia, ruota su cuscinetti a sfere,  
antitraccia, silencia, corpo centrale: Nylon rinforzato con fibra di vetro  
**RESISTENDO AGLI OLI/GRASSI/PETROLI...**

**Secteurs / Bereiche / Settori**

HUILE/ESSENCE  
OEL/BENZIN  
OLIV/PETROLI



USINE  
FABRIK  
INDUSTRIA

**Applications / Anwendung / Applicazioni**

BETON  
BETON  
CEMENTO



INDUSTRIE  
INDUSTRIE  
INDUSTRIA



TAPIS  
TEPPICH  
MOQUETTE

**Variantes / Varianten / Varianti**

-25° - +80° C  
85 Sh/A



**ROUE**  
PAGE 7.7  
60 – 490 kg



**SERIE 2.-3..**  
PAGE 3.5  
60 – 120 kg



**SERIE 55..**  
PAGE 4.4  
350 – 490 kg



**SERIE 5.-8..**  
PAGE 5.11-12  
120 – 480 kg

**AVEC PLAQUE / MIT PLATTE / A PIASTRA**

								ROUE PIVOTANTE LENKROLLE RUOTA GIREVOLE	PIVOTANT/FREIN LENKROLLE/BREMS GIREVOLE/FRENO		ROUE FIXE BOCKROLLE RUOTA FISSA			
mm	mm	Page 1.6	kg	mm	mm	mm	mm	Art. N :	CHF sans TVA	Art. N :	CHF sans TVA	Art. N :	CHF sans TVA	
<b>ZINGUE_SERIE N° 9 'EXTRA' (page 1.11)</b>														
125	46		390	140x110	105x80	12.5	176	45	9176.12	89.00	9276.12	118.50	9376.12	64.60
160	46		460	140x110	105x80	12.5	210	52	9176.16	99.00	9276.16	128.60	9376.16	77.50
200	50		490	140x110	105x80	12.5	250	58	9176.20	113.30	9276.20	141.80	9376.20	93.90
<b>INOX_SERIE N° 9 'EXTRA' (page 1.11)</b>														
<b>INOX / ROSTFREI / INOX (2RS)</b>														
A) 125	46		390	140x110	105x80	12.5	176	45	X-9176.12	261.50	X-9276.12	325.70	X-9376.12	233.60
A) 160	46		460	140x110	105x80	12.5	210	52	X-9176.16	275.40	X-9276.16	340.60	X-9376.16	249.90
A) 200	50		490	140x110	105x80	12.5	250	58	X-9176.20	299.00	X-9276.20	363.20	X-9376.20	276.50

A) EGALEMENT AVEC ROUEMENT A BILLES EN INOX +CHF 16.00 / AUCH MIT KUGELLAGER AUS ROSTFREI +CHF 16.00 / ANCHE CON CUSCINETTO A SFERE IN INOX +CHF 16.00

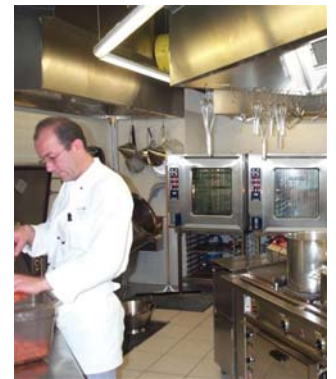
**ROULETTE JUMELÉE / ZWILLING-LENKROLLE / ROTELLE-GEMELLATA**

								ROUE PIVOTANTE LENKROLLE RUOTA GIREVOLE	PIVOTANT/FREIN LENKROLLE/BREMS GIREVOLE/FRENO		ROUE FIXE BOCKROLLE RUOTA FISSA		
mm	mm	Page 1.6	kg	mm	mm	mm	mm	Art. N :	CHF sans TVA	Art. N :	CHF sans TVA	Art. N :	CHF sans TVA
<b>ZINGUE_SERIE N° TH/TW 'EXTRA' (page 1.11)</b>													
125	2x46		730	B) 150x110	120x60 105x80	12.5	178	45	TH/TW 76.12	269.40	sur demande auf Anfrage	THR/TW 76.12	183.20
160	2x46		850	B) 150x110	120x60 105x80	12.5	208	50	TH/TW 76.16	294.40	sur demande auf Anfrage	THR/TW 76.16	204.40
200	2x50		950	B) 150x110	120x60 105x80	12.5	252	55	TH/TW 76.20	322.10	sur demande auf Anfrage	THR/TW 76.20	234.60

B) ROULETTE FIXE, PLAQUE 175x150mm / BOCKROLLE, PLATTE 175x150mm / RUOTA FISSA, PIASTRA 175x150mm



**ROULETTES D'INDUSTRIES A CHARGES ELEVÉES**

SUPPORT EN ACIER, INDÉFORMABLE, PROMAT-ZINGUÉ  
LARGE PALIER DE PIVOTEMENT EN ACIER TREMPÉ RENFORCÉ  
ROUE A PALIER LISSE, ROULEMENT A ROULEAUX OU A BILLES

**SCHWERLASTROLLEN FÜR INDUSTRIE**

GEHÄUSE AUS STAHL, VERSCHLEISSFEST, PROMAT-VERZ.  
BREITES SCHWENKLAGER AUS GEHÄRTETEM STAHL  
RAD MIT GLEITLAGER, ROLLENLAGER ODER KUGELLAGER

**RUOTE PER INDUSTRIE A CARICHI GRAVOSI**

SUPPORTI IN LAMIERA D'ACCIAIO, INALTERABILE, ZINCATO  
GRANDE PIROETTAMENTO SU PISTE D'ACCIAIO TEMPERATO  
RUOTA A FORO LISCIO, SU CUSCINETTO A RULLI E A SFERE

**390 – 950 kg****POLYURÉTHANE-ANTISTATIQUE**

Roue Polyuréthane injecté, gris, roue avec roulement à billes, non-tachant, silencieux  
résistant aux huiles/grasses/essences..., corps/roue: Nylon renforcé de fibres de verre

AVEC ROUES ANTISTATIQUES, RECOMMANDÉ POUR LES HÔPITAUX ET L'INDUSTRIE

**POLYURETHAN-ANTISTATISCH**

Rad mit Spritzguss-Polyurethan, grau, Rad mit Kugellager, spurfrei, Laufruhe  
beständigkeit gegen Öl/Fett/Benzin..., Radkörper: Nylon und Glasfaser Verbindung

MIT ANTISTATISCH-RÄDERN, EMPFOHLEN FÜR SPITÄLER UND INDUSTRIE

**POLIURETANO-ANTISTATICO**

Ruota rivestimento in Poliuretano iniettato, grigia, ruota su cuscinetti a sfere, antirivincia,  
silenziosa, resistendo agli oli/grassi/petroli..., corpo centrale: Nylon rinforzato con fibra di vetro

CON ANTISTATICO-RUOTE, RACCOMANDATÒ PER OSPEDALI ED INDUSTRIA

Secteurs / Bereiche / Settori



HUILE/ESSENCE  
OEL/BENZIN  
OLI/PETROLI



HOPITAL  
SPITAL  
HOSPITAL

Applications / Anwendung / Applicazioni



ANTISTATIQUE  
ANTISTATISCH  
ANTISTATICO

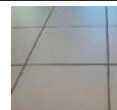

CARRELAGE  
FLIESEN  
PIASTRELLE



INDUSTRIE  
INDUSTRIE  
INDUSTRIA

Variantes / Varianten / Varianti



-25° - +80° C  
87 Sh/A



ROUE  
PAGE 7.8  
60 – 490 kg



SERIE 2...3...  
PAGE 3.6  
60 – 120 kg

























SERIE H...  
PAGE 3.12  
100 – 120 kg



SERIE 5...8...  
PAGE 5.13-14  
120 – 480 kg









AVEC PLAQUE / MIT PLATTE / A PIASTRA

								ROUE PIVOTANTE LENKROLLE RUOTA GIREVOLE	PIVOTANT/FREIN LENKROLLE/BREMS GIREVOLE/FRENO		ROUE FIXE BOCKROLLE RUOTA FISSA		
													
								Prix Preis Prezzo	Prix Preis Prezzo	Prix Preis Prezzo			
								Art. N :	CHF sans TVA	Art. N :	CHF sans TVA	Art. N :	CHF sans TVA
<b>ZINGUE_SERIE N° 9 'EXTRA' (page 1.11)</b>													
			Page 1.6										
mm	mm	kg	mm	mm	mm	mm	mm						
<b>125</b>	46	<b>390</b>	140x110	105x80	12.5	176	45	<b>9176.12-A</b>	122.40	<b>9276.12-A</b>	154.70	<b>9376.12-A</b>	99.90
<b>160</b>	46	<b>460</b>	140x110	105x80	12.5	210	52	<b>9176.16-A</b>	139.90	<b>9276.16-A</b>	172.30	<b>9376.16-A</b>	119.40
<b>200</b>	50	<b>490</b>	140x110	105x80	12.5	250	58	<b>9176.20-A</b>	174.00	<b>9276.20-A</b>	205.10	<b>9376.20-A</b>	156.80
<b>INOX_SERIE N° 9 'EXTRA' (page 1.11)</b>								<b>INOX / ROSTFREI / INOX (2RS)</b>					
A)								<b>X-9176.12-A</b>	291.90	<b>X-9276.12-A</b>	357.70	<b>X-9376.12-A</b>	263.40
A)								<b>X-9176.16-A</b>	312.60	<b>X-9276.16-A</b>	379.20	<b>X-9376.16-A</b>	286.60
A)								<b>X-9176.20-A</b>	355.30	<b>X-9276.20-A</b>	420.70	<b>X-9376.20-A</b>	332.20

A) EGALEMENT AVEC ROULEMENT A BILLES EN INOX +CHF 16.00 / AUCH MIT KUGELLAGER AUS ROSTFREI +CHF 16.00 / ANCHE CON CUSCINETTO A SFERE IN INOX +CHF 16.00



ROULETTE JUMELÉE / ZWILLING-LENKROLLE / ROTELLE-GEMELLATA

								ROUE PIVOTANTE LENKROLLE RUOTA GIREVOLE	PIVOTANT/FREIN LENKROLLE/BREMS GIREVOLE/FRENO		ROUE FIXE BOCKROLLE RUOTA FISSA		
													
								Prix Preis Prezzo	Prix Preis Prezzo	Prix Preis Prezzo			
								Art. N :	CHF sans TVA	Art. N :	CHF sans TVA	Art. N :	CHF sans TVA
<b>ZINGUE_SERIE N° TH/TW 'EXTRA' (page 1.11)</b>													
			Page 1.6										
mm	mm	kg	mm	mm	mm	mm	mm						
<b>125</b>	2x46	<b>730</b>	B) 150x110	120x60 105x80	12.5	178	45	<b>TH/TW 76.12-A</b>	346.60	sur demande auf Anfrage		<b>THR/TW 76.12-A</b>	252.20
<b>160</b>	2x46	<b>850</b>	B) 150x110	120x60 105x80	12.5	208	50	<b>TH/TW 76.16-A</b>	387.70	sur demande auf Anfrage		<b>THR/TW 76.16-A</b>	289.10
<b>200</b>	2x50	<b>950</b>	B) 150x110	120x60 105x80	12.5	252	55	<b>TH/TW 76.20-A</b>	456.30	sur demande auf Anfrage		<b>THR/TW 76.20-A</b>	360.40

B) ROULETTE FIXE, PLAQUE 175x150mm / BOCKROLLE, PLATTE 175x150mm / RUOTA FISSA, PIASTRA 175x150mm



**RABAIS / RABATT / SCONTO : 20% dès/ab/da 100.-- (CHF) / 25% dès/ab/da 500.-- (CHF)**  
RABAIS DE QUANTITE SUR DEMANDE ! MENGENRABATT AUF ANFRAGE ! SCONTO DI QUANTITA SU RICHIESTA !



**ROULETTES D'INDUSTRIES A CHARGES ELEVEES**

SUPPORT EN ACIER, INDEFORMABLE, PROMAT-ZINGUE  
LARGE PALIER DE PIVOTEMENT EN ACIER TREMPÉ RENFORCÉ  
ROUE A PALIER LISSE, ROULEMENT A ROULEAUX OU A BILLES

**SCHWERLASTROLLEN FÜR INDUSTRIE**

GEHÄUSE AUS STAHL, VERSCHLEISSFEST, PROMAT-VERZ.  
BREITES SCHWENKLAGER AUS GEHÄRTETEM STAHL  
RAD MIT GLEITLAGER, ROLLENLAGER ODER KUGELLAGER

**RUOTE PER INDUSTRIE A CARICHI GRAVOSI**

SUPPORTI IN LAMIERA D'ACCIAIO, INALTERABILE, ZINCATO  
GRANDE PIROETTAMENTO SU PISTE D'ACCIAIO TEMPERATO  
RUOTA A FORO LISCIO, SU CUSCINETTO A RULLI E A SFERE

**550 – 1800 kg**

**POLYURÉTHANE**

Roue Polyuréthane injecté, rouge/brun, roue avec roulement à billes, non-tachant, corps/roue: Nylon 6 renforcé de fibres de verre  
**RÉSISTANT AUX HUILES/GRAISSES/ESSENCES...**

**POLYURETHAN**

Rad mit Spritzguss-Polyurethan, rot/braun, Rad mit Kugellager, spurfrei, Radkörper: Nylon 6 und Glasfaser Verbindung  
**BESTÄNDIGKEIT GEGEN OEL/FETT/BENZIN...**

**POLIURETANO**

Ruota rivestimento in Poliuretano iniettato, rosso/marrone, ruota su cuscinetti a sfere, antitraccia, corpo centrale: Nylon 6 rinforzato con fibra di vetro  
**RESISTENDO AGLI OLI/GRASSI/PETROLI...**

**Secteurs / Bereiche / Settori**



HUILE/ESSENCE  
OEL/BENZIN  
OLII/PETROLI



USINE  
FABRIK  
INDUSTRIA

**Applications / Anwendung / Applicazioni**



GOUDRON  
ASPHALT  
ASFALTO



INDUSTRIE  
INDUSTRIE  
INDUSTRIA



BETON  
BETON  
CEMENTO

**Variantes / Varianten / Varianti**



-25° - +80° C  
94 Sh/A



ROUE  
PAGE 7.9  
550 – 850 kg



SERIE 55..  
PAGE 4.5  
350 – 500 kg



SERIE 5.-8..  
PAGE 5.16  
350 – 480 kg

**AVEC PLAQUE / MIT PLATTE / A PIASTRA**

										ROUE PIVOTANTE LENKROLLE RUOTA GIREVOLE		PIVOTANT/FREIN LENKROLLE/BREMS GIREVOLE/FRENO		ROUE FIXE BOCKROLLE RUOTA FISSA		
										Prix Preis Prezzo	Prix Preis Prezzo	Prix Preis Prezzo				
										Art. N :	CHF sans TVA	Art. N :	CHF sans TVA	Art. N :	CHF sans TVA	
<b>ZINGUE_SERIE N° 9 'EXTRA' (page 1.11)</b>																
125	46		550	140x110	105x80	12.5	176	45		91776.12	97.30	92776.12	129.00	93776.12	71.30	
160	46		650	140x110	105x80	12.5	210	52		91776.16	108.20	92776.16	139.80	93776.16	83.20	
200	50		900	140x110	105x80	12.5	250	58		91776.20	124.00	92776.20	154.60	93776.20	100.80	
<b>INOX_SERIE N° 9 'EXTRA' (page 1.11)</b>										<b>INOX / ROSTFREI / INOX (2RS)</b>						
A) 125	46		550	140x110	105x80	12.5	176	45		X-91776.12	281.00	X-92776.12	349.70	X-93776.12	251.40	
A) 160	46		650	140x110	105x80	12.5	210	52		X-91776.16	295.90	X-92776.16	365.50	X-93776.16	268.70	
A) 200	50		900	140x110	105x80	12.5	250	58		X-91776.20	321.90	X-92776.20	390.10	X-93776.20	297.80	

A) EGALEMENT AVEC ROULEMENT A BILLES EN INOX +CHF 16.00 / AUCH MIT KUGELLAGER AUS ROSTFREI +CHF 16.00 / ANCHE CON CUSCINETTO A SFERE IN INOX +CHF 16.00



**ROULETTE JUMELÉE / ZWILLING-LENKROLLE / ROTELLE-GEMELLATA**

										ROUE PIVOTANTE LENKROLLE RUOTA GIREVOLE		PIVOTANT/FREIN LENKROLLE/BREMS GIREVOLE/FRENO		ROUE FIXE BOCKROLLE RUOTA FISSA	
										Prix Preis Prezzo	Prix Preis Prezzo	Prix Preis Prezzo			
										Art. N :	CHF sans TVA	Art. N :	CHF sans TVA	Art. N :	CHF sans TVA
<b>ZINGUE_SERIE N° TH/TW 'EXTRA' (page 1.11)</b>															
125	2x46		1100	B) 150x110	120x60 105x80	12.5	178	45		TH/TW 776.12	292.80	sur demande auf Anfrage		THR/TW 776.12	200.50
160	2x46		1300	B) 150x110	120x60 105x80	12.5	208	50		TH/TW 776.16	319.30	sur demande auf Anfrage		THR/TW 776.16	223.00
200	2x50		1800	B) 150x110	120x60 105x80	12.5	252	55		TH/TW 776.20	350.20	sur demande auf Anfrage		THR/TW 776.20	256.50

B) ROULETTE FIXE, PLAQUE 175x150mm / BOCKROLLE, PLATTE 175x150mm / RUOTA FISSA, PIASTRA 175x150mm



**ROULETTES D'INDUSTRIES A CHARGES ELEVÉES**

SUPPORT EN ACIER, INDÉFORMABLE, PROMAT-ZINGUÉ  
LARGE PALIER DE PIVOTEMENT EN ACIER TREMPÉ RENFORCÉ  
ROUE A PALIER LISSE, ROULEMENT A ROULEAUX OU A BILLES

**SCHWERLASTROLLEN FÜR INDUSTRIE**

GEHÄUSE AUS STAHL, VERSCHLEISSFEST, PROMAT-VERZ.  
BREITES SCHWENKLAGER AUS GEHÄRTETEM STAHL  
RAD MIT GLEITLAGER, ROLLENLAGER ODER KUGELLAGER

**RUOTE PER INDUSTRIA A CARICHI GRAVOSI**

SUPPORTI IN LAMIERA D'ACCIAIO, INALTERABILE, ZINCATO  
GRANDE PIROETTAMENTO SU PISTE D'ACCIAIO TEMPERATO  
RUOTA A FORO LISCIO, SU CUSCINETTO A RULLI E A SFERE

**480 – 2400 kg****POLYURÉTHANE**

Roue Polyuréthane **ADIPRENE**, rouge/brun, roue avec roulement à billes, non-tachant, silencieux, corps/roue: Fonte

**RÉSISTANT AUX HUILES/GRAISSES/ESSENCES...**

**POLYURETHAN**

Polyurethanrad **ADIPREN**, rot/braun, Rad mit Kugellager, spurfrei, Laufruhe, Radkörper: Guss

**BESTÄNDIGKEIT GEGEN OEL/FETT/BENZIN...**

**POLIURETANO**

Ruota in Poliuretano **ADIPRENE**, rosso/marrone, ruota su cuscinetti a sfere, antitraccia, silenziosa, corpo centrale: Ghisa

**RESISTENDO AGLI OLI/GRASSI/PETROLI...**

**Secteurs / Bereiche / Settori**

HUILE/ESSENCE  
OEL/BENZIN  
OLI/PETROLI



USINE  
FABRIK  
INDUSTRIA

**Applications / Anwendung / Applicazioni**

INDUSTRIE  
INDUSTRIE  
INDUSTRIA



BETON  
BETON  
CEMENTO



GOUDRON  
ASPHALT  
ASFALTO

**Variantes / Varianten / Varianti**

-35° - +70° C  
92 Sh/A



**ROUE**  
PAGE 7.10  
300 – 4500 kg



**SERIE 55..**  
PAGE 4.4  
300 – 500 kg



**SERIE TH..**  
PAGE 6.7  
800 – 2700 kg

**AVEC PLAQUE / MIT PLATTE / A PIASTRA**

								ROUE PIVOTANTE LENKROLLE RUOTA GIREVOLE			PIVOTANT/FREIN LENKROLLE/BREMS GIREVOLE/FRENO			ROUE FIXE BOCKROLLE RUOTA FISSA					
mm	mm	Page 1.6	kg	mm	mm	mm	mm		Prix Preis Prezzo	Art. N :	CHF sans TVA		Prix Preis Prezzo	Art. N :	CHF sans TVA		Prix Preis Prezzo	Art. N :	CHF sans TVA
<b>ZINGUE_SERIE N° 9 'EXTRA' (page 1.11)</b>																			
125	50		750	140x110	105x80	12.5	176	45		9193.121	145.60			9293.121	174.00			9393.121	122.40
150	50		950	140x110	105x80	12.5	205 <sup>A)</sup>	52		9193.15	157.40			9293.15	184.80			9393.15	134.70
200	50		1200	140x110	105x80	12.5	250	58		9193.20	153.60			9293.20	180.40			9393.20	135.70
250	60		1600	200x160	160x120	12.5	325	85		9193.25	369.20			9293.25	411.40			9393.25	287.60

**ROULETTE JUMELÉE / ZWILLING-LENKROLLE / ROTELLE-GEMELLATA**

								ROUE PIVOTANTE LENKROLLE RUOTA GIREVOLE			PIVOTANT/FREIN LENKROLLE/BREMS GIREVOLE/FRENO			ROUE FIXE BOCKROLLE RUOTA FISSA					
mm	mm	Page 1.6	kg	mm	mm	mm	mm		Prix Preis Prezzo	Art. N :	CHF sans TVA		Prix Preis Prezzo	Art. N :	CHF sans TVA		Prix Preis Prezzo	Art. N :	CHF sans TVA
<b>ZINGUE_SERIE N° TH/TW 'EXTRA' (page 1.11)</b>																			
125	2x50		1500 <sup>B)</sup>	150x110	120x60 105x80	12.5	178	45		TH/TW 93.121	389.90			sur demande auf Anfrage				THR/TW 93.121	306.40
150	2x50		1900 <sup>B)</sup>	150x110	120x60 105x80	12.5	203	50		TH/TW 93.15	417.20			sur demande auf Anfrage				THR/TW 93.15	331.90
200	2x50		2400 <sup>B)</sup>	150x110	120x60 105x80	12.5	252	55		TH/TW 93.20	413.70			sur demande auf Anfrage				THR/TW 93.20	326.40

A) EGAGEMENT AVEC HAUTEUR TOTAL 189mm / AUCH MIT BAUHÖHE 189mm / ANCHE CON ALTEZZA UTILE 189mm

B) ROULETTE FIXE, PLAQUE 175x150mm / BOCKROLLE, PLATTE 175x150mm / RUOTA FISSA, PIASTRA 175x150mm



**RABAIS / RABATT / SCONTO : 20% dès/ab/da 100.-- (CHF) / 25% dès/ab/da 500.-- (CHF)**  
RABAIS DE QUANTITE SUR DEMANDE ! MENGENRABATT AUF ANFRAGE ! SCONTO DI QUANTITA SU RICHIESTA !

**ROULETTES D'INDUSTRIES A CHARGES ELEVEES**

SUPPORT EN ACIER, INDÉFORMABLE, PROMAT-ZINGUÉ  
LARGE PALIER DE PIVOTEMENT EN ACIER TREMPÉ RENFORCÉ  
ROUE A PALIER LISSE, ROULEMENT A ROULEAUX OU A BILLES

**SCHWERLASTROLLEN FÜR INDUSTRIE**

GEHÄUSE AUS STAHL, VERSCHLEISSFEST, PROMAT-VERZ.  
BREITES SCHWENKLAGER AUS GEHÄRTETEM STAHL  
RAD MIT GLEITLAGER, ROLLENLAGER ODER KUGELLAGER

**RUOTE PER INDUSTRIE A CARICHI GRAVOSI**

SUPPORTI IN LAMIERA D'ACCIAIO, INALTERABILE, ZINCATO  
GRANDE PIROETTAMENTO SU PISTE D'ACCIAIO TEMPERATO  
RUOTA A FORO LISCIO, SU CUSCINETTO A RULLI E A SFERE

**800 – 2700 kg****POLYURÉTHANE**

Roue Polyuréthane **VULKOLLAN**, rouge/brun, roue avec roulement à rouleaux ou à billes, non-tachant, silencieux, corps/roue: Fonte

**RÉSISTANT AUX HUILES/GRAISSES/ESSENCES...****POLYURETHAN**

Polyurethanrad **VULKOLLAN**, rot/braun, Rad mit Rollenlager oder Kugellager, spurfrei, Laufruhe, Radkörper: Guss

**BESTÄNDIGKEIT GEGEN OEL/FETT/BENZIN...****POLIURETANO**

Ruota in Poliuretano **VULKOLLAN**, rosso/marrone, ruota su cuscinetti a rulli e a sfere, antitraccia, silencia, corpo centrale: Ghisa

**RESISTENDO AGLI OLI/GRASSI/PETROLI...****Secteurs / Bereiche / Settori**

HUILE/ESSENCE  
OEL/BENZIN  
OLII/PETROLI



USINE  
FABRIK  
INDUSTRIA

**Applications / Anwendung / Applicazioni**

INDUSTRIE  
INDUSTRIE  
INDUSTRIA



BETON  
BETON  
CEMENTO



GOUDRON  
ASPHALT  
ASFALTO

**Variantes / Varianten / Varianti**

-35° - +70° C  
92 Sh/A



ROUE  
PAGE 7.11  
600 – 4000 kg

**AVEC PLAQUE / MIT PLATTE / A PIASTRA**

								ROUE PIVOTANTE LENKROLLE RUOTA GIREVOLE	Prix Preis Prezzo	PIVOTANT/FREIN LENKROLLE/BREMS GIREVOLE/FRENO	Prix Preis Prezzo	ROUE FIXE BOCKROLLE RUOTA FISSA	Prix Preis Prezzo	
mm	mm	Page 1.6	kg	mm	mm	mm	mm	Art. N :	CHF sans TVA	Art. N :	CHF sans TVA	Art. N :	CHF sans TVA	
<b>ZINGUE_SERIE N° TH 'EXTRA' (page 1.11)</b>														
125	38		800	150x110	120x60 105x80	12.5	178	45	TH 65 PTR	214.30	B/TH 65 PTR	282.20	THR 65 PTR	140.30
150	38		1100	150x110	120x60 105x80	12.5	203	50	TH 66 PTR	225.60	B/TH 66 PTR	295.00	THR 66 PTR	151.10
200	45		1500	150x110	120x60 105x80	12.5	252	55	TH 68 PTK	309.70	B/TH 68 PTK	377.10	THR 68 PTK	234.60
250	45		1600	150x110	120x60 105x80	12.5	303	70	TH 610 PTK	401.90	B/TH 610 PTK	473.60	THR 610 PTK	336.20
300	45		1700	150x110	120x60 105x80	12.5	353	85	TH 612 PTK	486.50	---	---	THR 612 PTK	414.00

**ROULETTE JUMELÉE / ZWILLING-LENKROLLE / ROTELLE-GEMELLATA**

								ROUE PIVOTANTE LENKROLLE RUOTA GIREVOLE	Prix Preis Prezzo	PIVOTANT/FREIN LENKROLLE/BREMS GIREVOLE/FRENO	Prix Preis Prezzo	ROUE FIXE BOCKROLLE RUOTA FISSA	Prix Preis Prezzo	
mm	mm	Page 1.6	kg	mm	mm	mm	mm	Art. N :	CHF sans TVA	Art. N :	CHF sans TVA	Art. N :	CHF sans TVA	
<b>ZINGUE_SERIE N° TH/TW 'EXTRA' (page 1.11)</b>														
125	2x38		1300	A) 150x110	120x60 105x80	12.5	178	45	TH/TW 65 PTR	373.70	sur demande auf Anfrage	---	THR/TW 65 PTR	288.50
150	2x38		2000	A) 150x110	120x60 105x80	12.5	203	50	TH/TW 66 PTR	396.90	sur demande auf Anfrage	---	THR/TW 66 PTR	307.10
200	2x45		2600	A) 150x110	120x60 105x80	12.5	252	55	TH/TW 68 PTR	506.70	sur demande auf Anfrage	---	THR/TW 68 PTR	417.40
200	2x45		2700	A) 150x110	120x60 105x80	12.5	252	55	TH/TW 68 PTK	556.40	sur demande auf Anfrage	---	THR/TW 68 PTK	467.20

A) ROULETTE FIXE, PLAQUE 175x150mm / BOCKROLLE, PLATTE 175x150mm / RUOTA FISSA, PIASTRA 175x150mm

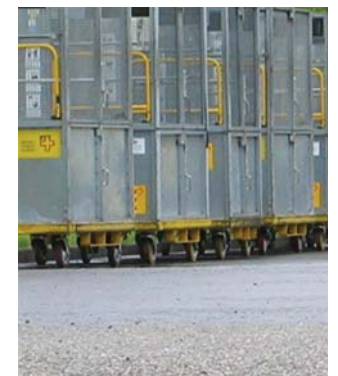

AVEC BLOCAGE DE DIRECTION  
MIT RICHTUNGSFESTSTELLER  
CON FRENO DIREZIONALE



**ROULETTES D'INDUSTRIES A CHARGES ELEVÉES**

SUPPORT EN ACIER, INDÉFORMABLE, PROMAT-ZINGUÉ  
LARGE PALIER DE PIVOTEMENT EN ACIER TREMPÉ RENFORCÉ  
ROUE A PALIER LISSE, ROULEMENT A ROULEAUX OU A BILLES

**SCHWERLASTROLLEN FÜR INDUSTRIE**

GEHÄUSE AUS STAHL, VERSCHLEISSFEST, PROMAT-VERZ.  
BREITES SCHWENKLAGER AUS GEHÄRTETEM STAHL  
RAD MIT GLEITLAGER, ROLLENLAGER ODER KUGELLAGER

**RUOTE PER INDUSTRIA A CARICHI GRAVOSI**

SUPPORTI IN LAMIERA D'ACCIAIO, INALTERABILE, ZINCATO  
GRANDE PIROETTAMENTO SU PISTE D'ACCIAIO TEMPERATO  
RUOTA A FORO LISCIO, SU CUSCINETTO A RULLI E A SFERE

**2600 – 6500 kg****POLYURÉTHANE**

Roue Polyuréthane **VULKOLLAN**, rouge/brun, roue avec roulement à rouleaux ou à billes, non-tachant, silencieux, corps/roue: Fonte

**RÉSISTANT AUX HUILES/GRAISSES/ESSENCES...****POLYURETHAN**

Polyurethanrad **VULKOLLAN**, rot/braun, Rad mit Rollenlager oder Kugellager, spurfrei, Laufruhe, Radkörper: Guss

**BESTÄNDIGKEIT GEGEN OEL/FETT/BENZIN...****POLIURETANO**

Ruota in Poliuretano **VULKOLLAN**, rosso/marrone, ruota su cuscinetti a rulli e a sfere, antitraccia, silenziosa, corpo centrale: Ghisa

**RESISTENDO AGLI OLI/GRASSI/PETROLI...****Secteurs / Bereiche / Settori**

HUILE/ESSENCE  
OEL/BENZIN  
OLI/PETROLI



USINE  
FABRIK  
INDUSTRIA

**Applications / Anwendung / Applicazioni**

INDUSTRIE  
INDUSTRIE  
INDUSTRIA



BETON  
BETON  
CEMENTO



GOUDRON  
ASPHALT  
ASFALTO

**Variantes / Varianten / Varianti**

-35° - +70° C  
92 Sh/A



**ROUE**  
PAGE 7.11  
600 – 4000 kg

**AVEC PLAQUE / MIT PLATTE / A PIASTRA**

ZINGUE_SERIE N° WP 'MAXI' (page 1.11)								ROUE PIVOTANTE LENKROLLE RUOTA GIREVOLE	Pivotant/Frein LENKROLLE/BREMS GIREVOLE/FRENO	ROUE FIXE BOCKROLLE RUOTA FISSA				
mm	mm	Page 1.6	kg	mm	mm	mm	mm	Art. N :	Prix Preis Prezzo	Art. N :	Prix Preis Prezzo	Art. N :	Prix Preis Prezzo	
200	75		2600	170x135	140x105	12.5	264	72	WP 88 PTK	597.50	B/WP 88 PTK	702.20	WPR 88 PTK	457.60
250	75		2800	170x135	140x105	12.5	314	82	WP 810 PTK	691.50	B/WP 810 PTK	808.40	WPR 810 PTK	553.60

ZINGUE_SERIE N° LT 'MAXI' (page 1.11)								ROUE PIVOTANTE LENKROLLE RUOTA GIREVOLE	Pivotant/Frein LENKROLLE/BREMS GIREVOLE/FRENO	ROUE FIXE BOCKROLLE RUOTA FISSA				
mm	mm	Page 1.6	kg	mm	mm	mm	mm	Art. N :	Prix Preis Prezzo	Art. N :	Prix Preis Prezzo	Art. N :	Prix Preis Prezzo	
250	75		3000	171x137	127x102	17	328	90	JX 810 PTS	932.10	sur demande auf Anfrage		JXR 810 PTS	625.20
300	75		3500	171x137	127x102	17	379	110	JX 812 PTS	1081.00	sur demande auf Anfrage		JXR 812 PTS	750.20
300	75		4200	<sup>A)</sup> 238x197	197x102	17	360	114	LT 812 PTS	1277.20	sur demande auf Anfrage		LTR 812 PTS	849.00



ZINGUE_SERIE N° LT/TW 'MAXI' (page 1.11)								ROUE PIVOTANTE LENKROLLE RUOTA GIREVOLE	Pivotant/Frein LENKROLLE/BREMS GIREVOLE/FRENO	ROUE FIXE BOCKROLLE RUOTA FISSA				
mm	mm	Page 1.6	kg	mm	mm	mm	mm	Art. N :	Prix Preis Prezzo	Art. N :	Prix Preis Prezzo	Art. N :	Prix Preis Prezzo	
300	2x75		6500	<sup>B)</sup> 238x197	197x102	17	369	129	LT/TW 812 PPTS	2276.60	sur demande auf Anfrage		LTR/TW 812 PPTS	1805.60



A) ROULETTE FIXE, PLAQUE 235x140mm / BOCKROLLE, PLATTE 235x140mm / RUOTA FISSA, PIASTRA 235x140mm

B) ROULETTE FIXE, PLAQUE 235x223mm / BOCKROLLE, PLATTE 235x223mm / RUOTA FISSA, PIASTRA 235x223mm

**RABAIS / RABATT / SCONTO : 20% dès/ab/da 100.-- (CHF) / 25% dès/ab/da 500.-- (CHF)**  
RABAIS DE QUANTITE SUR DEMANDE ! MENGENRABATT AUF ANFRAGE ! SCONTO DI QUANTITA SU RICHIESTA !

**ROULETTES D'INDUSTRIES A CHARGES ELEVEES**

SUPPORT EN ACIER, INDEFORMABLE, PROMAT-ZINGUE  
LARGE PALIER DE PIVOTEMENT EN ACIER TREMPÉ RENFORCÉ  
ROUE A PALIER LISSE, ROULEMENT A ROULEAUX OU A BILLES

**SCHWERLASTROLLEN FÜR INDUSTRIE**

GEHÄUSE AUS STAHL, VERSCHLEISSFEST, PROMAT-VERZ.  
BREITES SCHWENKLAGER AUS GEHÄRTETEM STAHL  
RAD MIT GLEITLAGER, ROLLENLAGER ODER KUGELLAGER

**RUOTE PER INDUSTRIE A CARICHI GRAVOSI**

SUPPORTI IN LAMIERA D'ACCIAIO, INALTERABILE, ZINCATO  
GRANDE PIROETTAMENTO SU PISTE D'ACCIAIO TEMPERATO  
RUOTA A FORO LISCIO, SU CUSCINETTO A RULLI E A SFERE

**700 – 2200 kg****POLYAMIDE / NYLON 6**

Roue Polyamide/Nylon 6, gris, roue avec roulement à rouleaux ou à billes, non-tachant, corps/roue: Nylon 6 renforcé de fibres de verre

**RÉSISTANT AUX HUILES/GRAISSES/ESSENCES...****POLYAMID / NYLON 6**

Polamid-Rad/Nylon 6, grau, Rad mit Rollenlager oder Kugellager, spurfrei, Radkörper: Nylon 6 und Glasfaser Verbindung

**BESTÄNDIGKEIT GEGEN OEL/FETT/BENZIN...****POLIAMMIDE / NYLON 6**

Ruota in Poliammide/Nylon 6, grigia, ruota su cuscinetti a rulli e a sfere, antitraccia, corpo centrale: Nylon 6 rinforzato con fibra di vetro

**RESISTENDO AGLI OLI/GRASSI/PETROLI...****Secteurs / Bereiche / Settori**

HUILE/ESSENCE  
OEL/BENZIN  
OLII/PETROLI



USINE  
FABRIK  
INDUSTRIA

**Applications / Anwendung / Applicazioni**

INDUSTRIE  
INDUSTRIE  
INDUSTRIA



BETON  
BETON  
CEMENTO



TAPIS  
TEPPICH  
MOQUETTE

**Variantes / Varianten / Varianti**

-30° - +80° C  
NYLON



ROUE  
PAGE 7.13-14  
55 – 2500 kg



SERIE 2.-3..  
PAGE 3.8  
50 – 110 kg



SERIE TL-55..  
PAGE 4.2-3  
180 – 600 kg



SERIE 5.-8..  
PAGE 5.17-19  
130 – 480 kg

**AVEC PLAQUE / MIT PLATTE / A PIASTRA**

								ROUE PIVOTANTE LENKROLLE RUOTA GIREVOLE		PIVOTANT/FREIN LENKROLLE/BREMS GIREVOLE/FRENO		ROUE FIXE BOCKROLLE RUOTA FISSA		
								Prix Preis Prezzo		Prix Preis Prezzo		Prix Preis Prezzo		
mm	mm	Page 1.6	kg	mm	mm	mm	mm	Art. N :	CHF sans TVA	Art. N :	CHF sans TVA	Art. N :	CHF sans TVA	
<b>ZINGUE_SERIE N° 9 'EXTRA' (page 1.11)</b>														
125	46		700	140x110	105x80	12.5	176	45	9166.12	92.20	9266.12	122.50	9366.12	67.10
160	46		900	140x110	105x80	12.5	210	52	9166.16	100.80	9266.16	131.40	9366.16	77.10
200	50		1100	140x110	105x80	12.5	250	58	9166.20	115.00	9266.20	143.70	9366.20	92.60
250	60		1300	200x160	160x120	14.5	325	85	9163.251	319.10	9263.251	363.60	9363.251	233.50
<b>INOX_SERIE N° 9 'EXTRA' (page 1.11)</b>														
<b>INOX / ROSTFREI / INOX (2RS)</b>														
A) 125	46		700	140x110	105x80	12.5	176	45	X-9166.12	268.10	X-9266.12	334.00	X-9366.12	224.30
A) 160	46		900	140x110	105x80	12.5	210	52	X-9166.16	280.90	X-9266.16	347.90	X-9366.16	240.20
A) 200	50		1100	140x110	105x80	12.5	250	58	X-9166.20	304.60	X-9266.20	369.80	X-9366.20	263.10

A) EGALEMENT AVEC ROULEMENT A BILLES EN INOX +CHF 16.00 / AUCH MIT KUGELLAGER AUS ROSTFREI +CHF 16.00 / ANCHE CON CUSCINETTO A SFERE IN INOX +CHF 16.00

**ROULETTE JUMELÉE / ZWILLING-LENKROLLE / ROTELLE-GEMELLATA**

								ROUE PIVOTANTE LENKROLLE RUOTA GIREVOLE		PIVOTANT/FREIN LENKROLLE/BREMS GIREVOLE/FRENO		ROUE FIXE BOCKROLLE RUOTA FISSA	
								Prix Preis Prezzo		Prix Preis Prezzo		Prix Preis Prezzo	
mm	mm	Page 1.6	kg	mm	mm	mm	mm	Art. N :	CHF sans TVA	Art. N :	CHF sans TVA	Art. N :	CHF sans TVA
<b>ZINGUE_SERIE N° TH/TW 'EXTRA' (page 1.11)</b>													
125	2x46		1400	150x110	120x60 105x80	12.5	178	45	TH/TW 66.12	277.10	sur demande auf Anfrage	THR/TW 66.12	189.10
160	2x46		1800	150x110	120x60 105x80	12.5	208	50	TH/TW 66.16	300.50	sur demande auf Anfrage	THR/TW 66.16	208.40
200	2x50		2200	150x110	120x60 105x80	12.5	252	55	TH/TW 66.20	329.40	sur demande auf Anfrage	THR/TW 66.20	237.70

B) ROULETTE FIXE, PLAQUE 175x150mm / BOCKROLLE, PLATTE 175x150mm / RUOTA FISSA, PIASTRA 175x150mm



**ROULETTES D'INDUSTRIES A CHARGES ELEVEES**

SUPPORT EN ACIER, INDEFORMABLE, PROMAT-ZINGUE  
LARGE PALIER DE PIVOTEMENT EN ACIER TREMPÉ RENFORCÉ  
ROUE A PALIER LISSE, ROULEMENT A ROULEAUX OU A BILLES

**SCHWERLASTROLLEN FÜR INDUSTRIE**

GEHÄUSE AUS STAHL, VERSCHLEISSFEST, PROMAT-VERZ.  
BREITES SCHWENKLAGER AUS GEHÄRTETEM STAHL  
RAD MIT GLEITLAGER, ROLLENLAGER ODER KUGELLAGER

**RUOTE PER INDUSTRIE A CARICHI GRAVOSI**

SUPPORTI IN LAMIERA D'ACCIAIO, INALTERABILE, ZINCATO  
GRANDE PIROETTAMENTO SU PISTE D'ACCIAIO TEMPERATO  
RUOTA A FORO LISCIO, SU CUSCINETTO A RULLI E A SFERE

1200 – 2700 kg

**POLYAMIDE / NYLON 6**

Roue Polyamide/Nylon 6, blanc, roue avec roulement à billes, non-tachant, corps/roue: Nylon 6

RÉSISTANT AUX HUILES/GRAISSES/ESSENCES...

**POLYAMID / NYLON 6**

Polyamid-Rad/Nylon 6, weiss, Rad mit Kugellager, spurfrei, Radkörper: Nylon 6 und Glasfaser verbindung

BESTÄNDIGKEIT GEGEN OEL/FETT/BENZIN...

**POLIAMMIDE / NYLON 6**

Ruota in Poliammide/Nylon 6, bianco, ruota su cuscinetti a sfere, antitraccia, corpo centrale: Nylon 6

RESISTENDO AGLI OLI/GRASSI/PETROLI...

Secteurs / Bereiche / Settori



HUILE/ESSENCE  
OEL/BENZIN  
OLI/PETROLI



USINE  
FABRIK  
INDUSTRIA

Applications / Anwendung / Applicazioni



INDUSTRIE  
INDUSTRIE  
INDUSTRIA



BETON  
BETON  
CEMENTO



TAPIS  
TEPPICH  
MOQUETTE

Variantes / Varianten / Varianti



-30° - +100° C  
NYLON 6



ROUE  
PAGE 7.13-14  
55 – 2500 kg



SERIE 2..3..  
PAGE 3.8  
50 – 110 kg



SERIE TL..  
PAGE 4.1-2  
80 – 600 kg



SERIE 5..8..  
PAGE 5.17-19  
130 – 480 kg

AVEC PLAQUE / MIT PLATTE / A PIASTRA

ZINGUE_SERIE N° TH 'EXTRA' (page 1.11)								ROUE PIVOTANTE LENKROLLE RUOTA GIREVOLE	Prix Preis Prezzo	PIVOTANT/FREIN LENKROLLE/BREMS GIREVOLE/FRENO	Prix Preis Prezzo	ROUE FIXE BOCKROLLE RUOTA FISSA	Prix Preis Prezzo
mm	mm	Page 1.6	kg	mm	mm	mm	mm	Art. N :	CHF sans TVA	Art. N :	CHF sans TVA	Art. N :	CHF sans TVA
150	50	1200	150x110	120x60 105x80	12.5	203	50	TH 66 NYK	216.30	B/TH 66 NYK	286.70	THR 66 NYK	138.20
200	50	1800	150x110	120x60 105x80	12.5	252	55	TH 68 NYK	258.90	B/TH 68 NYK	328.80	THR 68 NYK	182.90
250	60	2200	150x110	120x60 105x80	12.5	303	55	TH 610 NYK	386.20	B/TH 610 NYK	461.80	THR 610 NYK	312.70



ROULETTE JUMELÉE / ZWILLING-LENKROLLE / ROTELLE-GEMELLATA

ZINGUE_SERIE N° TH/TW 'EXTRA' (page 1.11)								ROUE PIVOTANTE LENKROLLE RUOTA GIREVOLE	Prix Preis Prezzo	PIVOTANT/FREIN LENKROLLE/BREMS GIREVOLE/FRENO	Prix Preis Prezzo	ROUE FIXE BOCKROLLE RUOTA FISSA	Prix Preis Prezzo
mm	mm	Page 1.6	kg	mm	mm	mm	mm	Art. N :	CHF sans TVA	Art. N :	CHF sans TVA	Art. N :	CHF sans TVA
150	2x50	2400	A) 150x110	120x60 105x80	12.5	203	50	TH/TW 66 NYK	375.40	sur demande auf Anfrage		THR/TW 66 NYK	283.10
200	2x50	2700	A) 150x110	120x60 105x80	12.5	252	55	TH/TW 68 NYK	455.20	sur demande auf Anfrage		THR/TW 68 NYK	363.60



A) ROULETTE FIXE, PLAQUE 175x150mm / BOCKROLLE, PLATTE 175x150mm / RUOTA FISSA, PIASTRA 175x150mm



AVEC BLOCAGE DE DIRECTION  
MIT RICHTUNGSFESTSTELLER  
CON FRENO DIREZIONALE

**RABAIS / RABATT / SCONTO : 20% dès/ab/da 100.-- (CHF) / 25% dès/ab/da 500.-- (CHF)**  
RABAIS DE QUANTITE SUR DEMANDE ! MENGENRABATT AUF ANFRAGE ! SCONTO DI QUANTITA SU RICHIESTA !



**ROULETTES D'INDUSTRIES A CHARGES ELEVEES**

SUPPORT EN ACIER, INDEFORMABLE, PROMAT-ZINGUE  
LARGE PALIER DE PIVOTEMENT EN ACIER TREMPÉ RENFORCÉ  
ROUE A PALIER LISSE, ROULEMENT A ROULEAUX OU A BILLES

**SCHWERLASTROLLEN FÜR INDUSTRIE**

GEHÄUSE AUS STAHL, VERSCHLEISSFEST, PROMAT-VERZ.  
BREITES SCHWENKLAGER AUS GEHÄRTETEM STAHL  
RAD MIT GLEITLAGER, ROLLENLAGER ODER KUGELLAGER

**RUOTE PER INDUSTRIE A CARICHI GRAVOSI**

SUPPORTI IN LAMIERA D'ACCIAIO, INALTERABILE, ZINCATO  
GRANDE PIROETTAMENTO SU PISTE D'ACCIAIO TEMPERATO  
RUOTA A FORO LISCIO, SU CUSCINETTO A RULLI E A SFERE

**900 – 2700 kg**

**FONTE**

Roue en Fonte pleine, gris, roue avec roulement à rouleaux, surface de roulement bombée, corps/roue: Fonte  
**RÉSISTANT AUX HUILES/GRAISSES/ESSENCES...**

**GUSS**

Guss-Rad, Vollscheibe, grau, Rad mit Rollenlager gewölbte Lauffläche, Radkörper: Guss  
**BESTÄNDIGKEIT GEGEN OEL/FETT/BENZIN...**

**GHISA**

Ruota in Ghisa, piena, grigia, ruota su cuscinetti a rulli superficie di rotolamento convessa, corpo centrale: Ghisa  
**RESISTENDO AGLI OLI/GRASSI/PETROLI...**

**Secteurs / Bereiche / Settori**



HUILE/ESSENCE  
OEL/BENZIN  
OLI/PETROLI



USINE  
FABRIK  
INDUSTRIA

**Applications / Anwendung / Applicazioni**



CHALEUR  
HITZEBESTANDIG  
ALTE TEMPERAT.

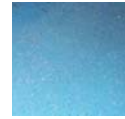

INDUSTRIE  
INDUSTRIE  
INDUSTRIA



BETON  
BETON  
CEMENTO

**Variantes / Varianten / Varianti**



-40° - +340° C  
FONTE



**ROUE**  
PAGE 7.12  
290 – 2500 kg



**SERIE 55..**  
PAGE 4.6  
230 - 320 kg

**AVEC PLAQUE / MIT PLATTE / A PIASTRA**

ZINGUE_SERIE N° TH 'EXTRA' (page 1.11)								ROUE PIVOTANTE LENKROLLE RUOTA GIREVOLE	Prix Preis Prezzo	PIVOTANT/FREIN LENKROLLE/BREMS GIREVOLE/FRENO	Prix Preis Prezzo	ROUE FIXE BOCKROLLE RUOTA FISSA	Prix Preis Prezzo	
mm	mm	Page 1.6	kg	mm	mm	mm	mm	Art. N :	CHF sans TVA	Art. N :	CHF sans TVA	Art. N :	CHF sans TVA	
125	45		900	150x110	120x60 105x80	12.5	178	45	TH 65 CIR	184.10	B/TH 65 CIR	252.10	THR 65 CIR	109.00
150	45		1200	150x110	120x60 105x80	12.5	203	50	TH 66 CIR	192.60	B/TH 66 CIR	262.00	THR 66 CIR	118.00
200	45		2000	150x110	120x60 105x80	12.5	252	55	TH 68 CIR	227.00	B/TH 68 CIR	296.40	THR 68 CIR	153.90
250	55		2200	150x110	120x60 105x80	12.5	303	70	TH 610 CIR	325.00	B/TH 610 CIR	400.30	THR 610 CIR	253.50



**ROULETTE JUMELÉE / ZWILLING-LENKROLLE / ROTELLE-GEMELLATA**

ZINGUE_SERIE N° TH/TW 'EXTRA' (page 1.11)								ROUE PIVOTANTE LENKROLLE RUOTA GIREVOLE	Prix Preis Prezzo	PIVOTANT/FREIN LENKROLLE/BREMS GIREVOLE/FRENO	Prix Preis Prezzo	ROUE FIXE BOCKROLLE RUOTA FISSA	Prix Preis Prezzo
mm	mm	Page 1.6	kg	mm	mm	mm	mm	Art. N :	CHF sans TVA	Art. N :	CHF sans TVA	Art. N :	CHF sans TVA
125	2x45		1800	A) 150x110	120x60 105x80	12.5	178	45	TH/TW 65 CIR	313.30	sur demande auf Anfrage	THR/TW 65 CIR	228.00
150	2x45		2400	A) 150x110	120x60 105x80	12.5	203	50	TH/TW 66 CIR	330.80	sur demande auf Anfrage	THR/TW 66 CIR	241.10
200	2x45		2700	A) 150x110	120x60 105x80	12.5	252	55	TH/TW 68 CIR	394.60	sur demande auf Anfrage	THR/TW 68 CIR	305.50



A) ROULETTE FIXE, PLAQUE 175x150mm / BOCKROLLE, PLATTE 175x150mm / RUOTA FISSA, PIASTRA 175x150mm



AVEC BLOCAGE DE DIRECTION  
MIT RICHTUNGSFESTSTELLER  
CON FRENO DIREZIONALE



**ROUES / ACCESSOIRES**

**RÄDER / ZUBEHÖR**

**RUOTE / ACCESSORI**

# 7



**40 – 4'500 kg**



**50 - 500 mm**

INDEX / INHALT / INDICE



**PAGE 7.1**  
CAOUTCH-TER  
GUMMI-THERMO  
GOMMA-TERMO



**PAGE 7.2**  
CAOUTCHOUC  
GUMMI  
GOMMA



**PAGE 7.3**  
CAOUTCHOUC  
GUMMI  
GOMMA



**PAGE 7.3-4**  
CAOUTCHOUC  
GUMMI  
GOMMA

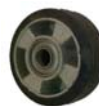

**PAGE 7.5**  
CAOUTCH-ELAST  
GUMMI-ELAST  
GOMMA-ELAST



**PAGE 7.6**  
CAOUTCH-ELAST  
GUMMI-ELAST  
GOMMA-ELAST



**PAGE 7.6**  
PNEU-SOFT  
SOFT-REIFEN  
PNEU-SOFT



**PAGE 7.6**  
PNEUMATIQUE  
LUFT-REIFEN  
PNEUMATICHE



**PAGE 7.7**  
POLYURETHANE  
POLYURETHAN  
POLIURETANO



**PAGE 7.8**  
ANTISTATIQUE  
ANTISTATISCH  
ANTISTATICO



**PAGE 7.9**  
POLYURETHANE  
POLYURETHAN  
POLIURETANO



**PAGE 7.9**  
POLYURETHANE  
POLYURETHAN  
POLIURETANO



**PAGE 7.10-11**  
POLYURETHANE  
POLYURETHAN  
POLIURETANO



**PAGE 7.12**  
FONTE  
GUSS  
GHISA



**PAGE 7.12**  
ROUE CHALEUR  
HITZBESTÄNDIG  
ALTE TEMPERAT.



**PAGE 7.13-14**  
POLYAMID-NYLON  
POLYAMID-NYLON  
POLIAMMID-NYLON

SECTEURS / BEREICHE / SETTORI



**WEMAS Sàrl - CH-2720 TRAMELAN**

ROUES-ROULETTES / RÄDER-ROLLEN / RUOTE-ROTELLE / WHEELS-CASTORS

TELEPHONE **032 487 43 28** / FAX **032 487 44 43**

INTERNET **www.wemas.ch** / E-MAIL **info@wemas.ch**



50 – 310 kg

**CAOUTCHOUC/Thermoplastique**

Roue Caoutchouc Thermoplastique, gris, roue à palier lisse ou avec roulement à billes, non-tachant, silencieux, corps/roue: Nylon renforcé de fibres de verre

RECOMMANDÉ POUR LES CUISINES, LES HOPITAUX ET LES AGENCEMENTS

**GUMMI/Thermoplastisch**

Gummirad Thermoplastisch, grau, Rad mit Gleitlager oder Kugellager, spurfrei, Laufruhe, Radkörper: Nylon und Glasfaser Verbindung

EMPFOHLEN FÜR DIE KÜCHEN, DIE SPITÄLER UND DIE EINRICHTUNGEN

**GOMMA/Termoplastica**

Ruota in Gomma Termoplastica, grigia, ruota a foro liscio o su cuscinetti a sfere, antitraccia, silenziosa, corpo centrale: Nylon rinforzato con fibre di vetro

RACCOMANDATO PER LE CUCINE, OSPEDALI E PER ARREDAMENTO

mm	mm	Page 1.6	kg	mm	mm	Art. N :	Prix Preis Prezzo	CHF sans TVA	Art. N :	Prix Preis Prezzo	CHF sans TVA
<b>SERIE 'LEGER' &gt;&gt;Appareil</b>											
A)	50	19	50	22	8	11.05x19	3.90		X-11.05x19	3.90	
	50	19	50	22	6	13.05x19	7.50		---		
A)	60	25	65	28	8	11.06x25	5.20		X-11.06x25	5.20	
	60	25	75	32	6	13.06x25	9.30		X-13.06x25	9.30	
A)	75	24	75	28	8	11.07x25	5.80		X-11.07x25	5.80	
	75	24	75	30	8	13.07x25	10.50		---		
	80	25	85	32	8	13.08x25	11.90		X-13.08x25	11.90	
B)	80	25	85	32	8	13.08x25-S	14.40		X-13.08x25-S	14.40	
A)	100	25	95	30	12	11.10x25	8.60		X-11.10x25	8.60	
	100	25	95	32	8	13.10x25	14.60		X-13.10x25	14.60	
A)	125	25	100	30	12	11.12x25	11.80		X-11.12x25	11.80	
	125	25	100	32	8	13.12x25	17.00		X-13.12x25	17.00	
<b>SERIE 'MEDIA' &gt;&gt;Appareil-Transport</b>											
A)	80	32	100	36	12	11.08x32	6.80		X-11.08x32	6.80	
	80	32	100	38 (42)	8	13.08x32	13.00		X-13.08x32	13.00	
A)	100	32	120	36	12	11.10x32	9.50		X-11.10x32	9.50	
	100	32	120	38 (42)	8	13.10x32	15.80		X-13.10x32	15.80	
B)	100	32	120	38 (42)	8	13.10x32-S	18.40		X-13.10x32-S	18.40	
A)	125	32	120	36	12	11.12x32	12.20		X-11.12x32	12.20	
	125	37	130	50	10	12.12x37	21.30		---	0.00	
	125	32	120	38 (50)	8 (10)	13.12x32	19.40		X-13.12x32	19.40	
B)	125	32	120	39	8	13.12x32-S	21.30		X-13.12x32-S	21.30	
	150	32	130	38 (34)	8 (12)	13.15x32	31.90		X-13.15x32	31.90	
	200	32	130	38 (34)	8 (12)	13.20x32	44.10		X-13.20x32	44.10	
<b>SERIE 'FORT' &gt;&gt;Transport</b>											
A)	125	46	190	C) 50 (60)	20 (12)	16.12x46	28.20		X-16.12x46	46.30	
A)	160	46	250	C) 50 (60)	20 (12)	16.16x46	39.60		X-16.16x46	57.70	
A)	200	50	310	C) 50 (60)	20 (12)	16.20x50	53.90		X-16.20x50	71.90	

A) ROUE SANS PARE-FILES / RAD OHNE FADENSCHUTZ / RUOTA SENZA PARAFILI

B) AVEC CAOUTCHOUC-ELASTIQUE 75 Sh/A / MIT ELASTISCHE-GUMMI 75 Sh/A / CON GOMMA-ELASTICA 75 Sh/A

C) EGAGEMENT AVEC MOYEU 60/12mm +CHF 6.00, EN INOX +CHF 9.00 / AUCH MIT NABENLANGE 60/12mm +CHF 6.00, AUS ROSTFREI +CHF 9.00 / ANCHE CON MOZZO 60/12mm +CHF 6.00, IN INOX +CHF 9.00

**Secteurs / Bereiche / Settori**

HOPITAL  
SPITAL  
OSPEDALE



CUISINE  
KÜCHE  
CUCINA



CARRELAGE  
FLIESEN  
PIASTRELLE



PARQUET BOIS  
HOLZ-PARKETT  
PARQUET



INDUSTRIE  
INDUSTRIE  
INDUSTRIA

**Applications / Anwendung / Applicazioni****Variantes / Varianten / Varianti**

-20° - +80° C  
87 Sh/A



SERIE 2.-3..  
PAGE 3.1-2  
50 – 120 kg



SERIE H..  
PAGE 3.11  
100 – 120 kg



SERIE 5.-8..  
PAGE 5.1  
90 – 310 kg

**Roues / Räder / Ruote**

**NON-TACHANT**, N'abîme pas les sols, Roulement souple et silencieux, Résistant aux produits d'entretien et désinfectant

**SPURFREI**, Bodenschonend, Geräuscharmer Lauf, Beständig gegen Desinfektions- und Reinigungsmittel

**NON MACCHIANDO**, Non danneggia il suolo, Otolamento flessibile e calmo, Resistente ai prodotti d'intervista/disinfectante



50 – 200 kg

## CAOUTCHOUC

Roue Caoutchouc Plein, gris, roue à palier lisse ou avec roulement à rouleaux, non-tachant, silencieux, corps/roue: Polyamide

GRIS - NON-TACHANT

## GUMMI

Vollgummirad, grau, Rad mit Gleitlager oder Rollenlager, spurfrei, Laufruhe, Radkörper: Polyamid

GRAU - SPURFREI

## GOMMA

Ruota in Gomma, grigia, ruota a foro liscio o su cuscinetti a rulli, antitraccia, silenziosa, corpo centrale: Poliammide

GRIGIA - ANTITRACCIA

mm	mm	Page 1.6	kg	mm	mm	Art. N :	CHF sans TVA	Art. N :	CHF sans TVA
<b>SERIE 'MEDIA' &gt;&gt;Transport</b>									
80	25		50	40	12	21.08-G	5.90	X-21.08-G	5.90
100	30		75	40	12	21.10-G	8.40	X-21.10-G	8.40
125	38		100	50	15	21.12-G	12.50	X-21.12-G	12.50
140	38		110	50	15	21.14-G	14.20	X-21.14-G	14.20
150	45		130	60	20	22.15-G	20.70	---	---
160	40		140	45	20	21.16-G	16.80	X-21.16-G	16.80
160	40		150	60	20	22.16-G	23.30	X-22.16-G	28.40
180	45		170	60	20	22.18-G	28.00	X-22.18-G	33.20
200	50		200	60	20	22.20-G	37.40	X-22.20-G	42.60

## Secteurs / Bereiche / Settori



HOPITAL  
SPITAL  
OSPEDALE



MAGASIN  
BETRIEB  
COMMERCIO



CARRELAGE  
FLIESEN  
PIASTRELLE



PARQUET BOIS  
HOLZ-PARKETT  
PARQUET



LINO  
LINOLEUM

## Applications / Anwendung / Applicazioni

## Variantes / Varianten / Varianti



-10° - +65° C  
85 Sh/A



SERIE 5.-.8..  
PAGE 5.3  
50 - 200 kg

## Roues / Räder / Ruote



**NON-TACHANT**, N'abime pas les sols, Ne nécessite aucun entretien, Bonne résistance à l'usure

**SPURFREI**, Bodenschonend, Wartungsfrei, Gute Verschleissfestigkeit

**NON MACCHIANDO**, Non danneggia il suolo, Non richiede alcun'intervista, Buona resistenza all'usura



PAGE / SEITE / PAGINA 7.5



PAGE / SEITE / PAGINA 7.1-2



PAGE / SEITE / PAGINA 7.6



PAGE / SEITE / PAGINA 7.3



PAGE / SEITE / PAGINA 7.3



PAGE / SEITE / PAGINA 7.13



PAGE / SEITE / PAGINA 7.1-2



PAGE / SEITE / PAGINA 7.1



PAGE / SEITE / PAGINA 7.6



PAGE / SEITE / PAGINA 7.7-8

**RABAIS / RABATT / SCONTO : 20% dès/ab/da 100.-- (CHF) / 25% dès/ab/da 500.-- (CHF)**  
RABAIS DE QUANTITE SUR DEMANDE ! MENGENRABATT AUF ANFRAGE ! SCONTO DI QUANTITA SU RICHIESTA !

50 – 295 kg

## CAOUTCHOUC

Roue Caoutchouc Plein, noir, roue à palier lisse ou avec roulement à rouleaux, silencieux, corps/roue: Polyamide

LE CAOUTCHOUC NOIR PEUT MARQUER LE SOL !!

mm	mm	Page 1.6	kg	mm	mm	Art. N :	Prix Preis Prezzo	CHF sans TVA
<b>SERIE 'MEDIA' &gt;&gt;Transport</b>								
80	25		50	40	12	21.08	4.90	
100	30		75	40	12	21.10	6.30	
125	38		100	50	15	21.12	8.80	
150	38		120	50	15	21.15	12.50	
<sup>A)</sup> 160	40		150	60	20	22.16	17.80	
<sup>A)</sup> 180	45		170	60	20	22.18	20.90	
<sup>A)</sup> 200	50		200	60	20	22.20	22.60	
<sup>A)</sup> 250	60		295	75	25	22.25	46.30	

A) EGALEMENT AVEC PALIER LISSE +CHF 3.00 / AUCH MIT GLEITLAGER +CHF 3.00 / ANCHE A FORO LISCIO +CHF 3.00

## GUMMI

Vollgummirad, schwarz, Rad mit Gleitlager oder Rollenlager, Laufruhe, Radkörper: Polyamid

SCHWARZGUMMI IST NICHT SPURFREI !!

## GOMMA

Ruota in Gomma, nera, ruota a foro liscio o su cuscinetti a rulli, silenziosa, corpo centrale: Poliammide

LA GOMMA NERA PUÒ SEGNARE IL SUOLO !!

## Secteurs / Bereiche / Settori

MAGASIN  
BETRIEB  
COMMERCIO

## Applications / Anwendung / Applicazioni

MANUTENTION  
TRANSPORT  
TRASPORTOBETON  
BETON  
CEMENTOGOUDRON  
ASPHALT  
ASFALTOINDUSTRIE  
INDUSTRIE  
INDUSTRIA

## Variantes / Varianten / Varianti

-15° - +65° C  
85 Sh/ASERIE 5...8..  
PAGE 5.4  
50 – 200 kg

## Roues / Räder / Ruote

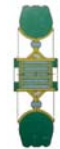

N'abîme pas les sols, Ne nécessite aucun entretien, Bonne résistance à l'usure  
Bodenschonend, Wartungsfrei, Gute Verschleissfestigkeit  
Non danneggia il suolo, Non richiede alcun'intervista, Buona resistenza all'usura

50 – 395 kg

## CAOUTCHOUC

Roue Caoutchouc Plein, noir, roue avec roulement à rouleaux, silencieux  
corps/roue: tôle d'acier, zingué

LE CAOUTCHOUC NOIR PEUT MARQUER LE SOL !!

mm	mm	Page 1.6	kg	mm	mm	Art. N :	Prix Preis Prezzo	CHF sans TVA
<b>SERIE 'MEDIA' &gt;&gt;Transport</b>								
80	25		50	40	12	42.08	7.40	
100	30		75	40	12	42.10	8.80	
125	38		100	50	15	42.12	13.70	
140	38		120	50	15	42.14	17.00	
150	38		140	50	20	42.15	19.60	
160	40		160	60	20	42.16	21.60	
180	45		180	60	20	42.18	25.20	
200	50		210	60	20	42.20	27.60	
250	60		295	75	25	42.25	78.80	
280	70		395	75	25	42.28	101.20	

## GUMMI

Vollgummirad, schwarz, Rad mit Rollenlager Laufruhe,  
Radkörper: Stahl-Felge, Glanzverzinkt

SCHWARZGUMMI IST NICHT SPURFREI !!

## GOMMA

Ruota in Gomma, nera, ruota su cuscinetti a rulli, silenziosa,  
corpo centrale: dischi in acciaio zincato

LA GOMMA NERA PUÒ SEGNARE IL SUOLO !!

## Secteurs / Bereiche / Settori

MANUTENTION  
TRANSPORT  
TRASPORTOCONTAINER  
CONTAINER  
CASSONETTIBETON  
BETON  
CEMENTOGOUDRON  
ASPHALT  
ASFALTOPAVE  
PFLASTER-STEIN  
PAVIMENTO

## Variantes / Varianten / Varianti

-10° - +65° C  
85 Sh/ASERIE 5...8..  
PAGE 5.5  
50 – 395 kg

## Roues / Räder / Ruote

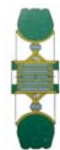

N'abîme pas les sols, Ne nécessite aucun entretien, Bonne résistance à l'usure  
Bodenschonend, Wartungsfrei, Gute Verschleissfestigkeit  
Non danneggia il suolo, Non richiede alcun'intervista, Buona resistenza all'usura

400 – 650 kg

## CAOUTCHOUC

Roue Caoutchouc Plein, noir, roue avec roulement à rouleaux, silencieux  
corps/roue : tôle d'acier, zingué

RECOMMANDÉ POUR DES CHARGES ÉLEVÉES

mm	mm	Page 1.6	kg	mm	mm	Art. N :	Prix Preis Prezzo CHF sans TVA
<b>SERIE 'EXTRA' &gt;Transport</b>							
200	70(85)		400	90	25	MT 20	100.60
250	55(85)		450	90	25	MT 25	125.00
300	60(85)		500	90	25	MT 30	146.80
400	65(85)		650	90	30	MT 40	215.40

## GUMMI

Vollgummirad, schwarz, Rad mit Rollenlager  
Laufruhe,  
Radkörper: Stahl-Felge, Glanzverzinkt

EMPFOLHEN FÜR HOHE BELASTBARKEIT

## GOMMA

Ruota in Gomma, nera, ruota su cuscinetti a rulli,  
silenciosa,  
corpo centrale: dischi in acciaio zincato

RACCOMANDATÒ PER CARICHI GRAVOSI

## Secteurs / Bereiche / Settori

MANUTENTION  
TRANSPORT  
TRASPORTOMANUTENTION  
TRANSPORT  
TRASPORTO

## Applications / Anwendung / Applicazioni

BETON  
BETON  
CEMENTOGOUDRON  
ASPHALT  
ASFALTOPAVE  
PFLASTER-STEIN  
PAVIMENTO

## Roues / Räder / Ruote

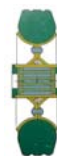
-15° - +65° C  
85 Sh/A

Charge admissible élevée, Faible résistance au roulement, Bonne résistance à l'usure

Hohe Belastbarkeit, Geringer Anfahrwiderstand, Gute Verschleissfestigkeit

Carico ammissibile elevato, Debole resistenza al rotolamento, Buona resistenza all'usura

900 – 2800 kg

## CAOUTCHOUC ÉLASTIQUE

Roue Caoutchouc Élastique, noir, roue avec roulement à billes, silencieux, extra-souple  
corps/roue: Acier trempé renforcé

RECOMMANDÉ POUR DES CHARGES ÉLEVÉES

mm	mm	Page 1.6	kg	mm	mm	Art. N :	Prix Preis Prezzo CHF sans TVA
<b>SERIE 'EXTRA' &gt;&gt;Industrie</b>							
200	100		900	100	30	WCS 20x100	280.00
250	100		1200	100	30	WCS 25x100	341.80
300	100		1400	100	35	WCS 30x100	413.70
400	100		1600	100	35	WCS 40x100	543.00
<b>SERIE 'MAXI' &gt;&gt;Industrie</b>							
200	150		1200	150	35	WCS 20x150	425.90
250	150		1400	150	35	WCS 25x150	488.50
300	A) 150		1800	150	40	WCS 30x150	536.70
400	A) 150		2200	150	40	WCS 40x150	758.40
500	A) 150		2800	150	60	WCS 50x150	1019.90

A) ÉGALEMENT AVEC 200 OU 300mm / AUCH MIT 200 ODER 300mm / ANCHE CON 200 O 300mm

## ELASTISCH-GUMMI

Elastisches Vollgummirad, schwarz, Rad mit Kugellager  
Laufruhe, extra-weich  
Radkörper: mit gehärtetem Stahl

EMPFOLHEN FÜR HOHE BELASTBARKEIT

## GOMMA-ELASTICA

Ruota in Gomma Elastica, blu/grigia, ruota su cuscinetti a rulli o a sfere, antitraccia, silenciosa, grande elasticità  
corpo centrale: Acciaio stampato

RACCOMANDATÒ PER CARICHI GRAVOSI

## Secteurs / Bereiche / Settori

MANUTENTION  
TRANSPORT  
TRASPORTOMANUTENTION  
TRANSPORT  
TRASPORTO

## Applications / Anwendung / Applicazioni

BETON  
BETON  
CEMENTOGOUDRON  
ASPHALT  
ASFALTOPAVE  
PFLASTER-STEIN  
PAVIMENTO

## Roues / Räder / Ruote

-20° - +70° C  
75 Sh/A

Charge admissible élevée, Faible résistance au roulement, Bonne résistance à l'usure

Hohe Belastbarkeit, Geringer Anfahrwiderstand, Gute Verschleissfestigkeit

Carico ammissibile elevato, Debole resistenza al rotolamento, Buona resistenza all'usura

RABAIS / RABATT / SCONTO :

20% dès/ab/da 100.-- (CHF)

RABAIS DE QUANTITE SUR DEMANDE !

MENGENRABATT AUF ANFRAGE !

/ 25% dès/ab/da 500.-- (CHF)

SCONTO DI QUANTITA SU RICHIESTA !



140 – 480 kg

## CAOUTCHOUC SUPER-ÉLASTIQUE

Roue Caoutchouc Super-Elastique, bleu/gris, roue avec roulement à rouleaux ou à billes, silencieux, non-tachant, extra-souple, corps/roue: Nylon 6

RECOMMANDÉ POUR LES HALLES POLYVALENTES, LES HOPITAUX ET DANS L'ALIMENTATION

## ELASTISCH-GUMMI

Elastisches Vollgummirad, blau/grau, Rad mit Rollenlager oder Kugellager, spurfrei, Laufruhe, extra-weich Radkörper: Nylon 6

EMPFOHLEN FÜR DIE MEHRZWECKHALLEN, DIE SPITÄLER UND FÜR LEBENSMITTEL

## GOMMA-ELASTICA

Ruota in Gomma Elastica, blu/grigia, ruota su cuscinetti a rulli o a sfere, antiraccia, silenziosa, grande elasticità corpo centrale: Nylon 6

RACCOMANDATO PER LE CENTRO SPORTIVO, L'OSPEDALI ED PER L'ALIMENTAZIONE

mm	mm	Page 1.6	kg	mm	mm	Art. N :	CHF sans TVA	Art. N :	CHF sans TVA
<b>SERIE 'FORT' &gt;Transport-Industrie</b>									
80	32		140	40	12	32.08	23.00	X-32.08	28.10
100	32		200	40	12	32.10	18.90	X-32.10	24.10
125	40		250	50	15	32.12	26.70	X-32.12	31.80
160	50		350	60	20	32.16	48.30	X-32.16	54.80
200	50		420	60	20	32.20	61.70	X-32.20	68.10
<sup>A)</sup> 200	50		450	50 (60)	20	33.20	70.30	X-33.20	75.50
<sup>A)</sup> 250	45		480	50 (60)	25	33.25	107.30	X-33.25	120.20
<sup>B)</sup> 100	36		180	42	8	33.10-G	34.20	X-33.10-G	34.20
<sup>B)</sup> 125	38		250	52	10	33.12-G	37.10	X-33.12-G	37.10
<sup>B)</sup> 160	48		300	62	12	33.16-G	67.30	X-33.16-G	67.30
<sup>B)</sup> 200	48		400	62	12	33.20-G	82.30	X-33.20-G	82.30

A) EGALEMENT AVEC ROULEMENT A BILLES EN INOX +CHF 16.00 / AUCH MIT KUGELLAGER AUS ROSTFREI +CHF 16.00 / ANCHE CON CUSCINETTO A SFERE IN INOX +CHF 16.00

B) CAOUTCHOUC-ELASTIQUE GRIS +PARE-FILS DE PROTECTION DU ROULEMENT (LAVAGE PAR STÉRILISATION) / ELASTISCH-GUMMI GRAU +FADENFÄNGER ZUM LAGERSCHUTZ (WASCHEN DURCH STERILISATION) / GOMMA-ELASTICA +PROTEZIONE DEL CUSCINETTO (LAVAGGIO DI STERILIZZAZIONE)

RABAIS SPÉCIAL 'SET FLIGHT-CASES' PAGE 5.21 / SPEZIAL-RABATT 'SET FLIGHT-CASES' SEITE 5.21 / SCONTO SPECIALE 'SET FLIGHT-CASES' PAGINA 5.21

200 – 495 kg

## CAOUTCHOUC SUPER-ÉLASTIQUE

Roue Caoutchouc Super-Elastique, noir, roue avec roulement à billes, silencieux, extra-souple, corp/roue: Aluminium

LE CAOUTCHOUC NOIR PEUT MARQUER LE SOL !!

## ELASTISCH-GUMMI

Elastisches Vollgummirad, schwarz, Rad mit Kugellager Laufruhe, extra-weich, Radkörper: Aluminium

SCHWARZGUMMI IST NICHT SPURFREI !!

## GOMMA-ELASTICA

Ruota in Gomma Elastica, nera, ruota su cuscinetti a sfere, silenziosa, grande elasticità, corp.cent: Alluminio

LA GOMMA NERA PUÒ SEGNARE IL SUOLO !!

mm	mm	Page 1.6	kg	mm	mm	Art. N :	CHF sans TVA	Art. N :	CHF sans TVA
<b>SERIE 'FORT' &gt;Transport-Industrie</b>									
<sup>B)</sup> 100	40		200	40	12 (15)	53.10	38.10	X-53.10	43.20
<sup>B)</sup> 125	50		280	60	20	53.12	54.00	X-53.12	60.40
<sup>B)</sup> 160	50		350	60	<sup>A)</sup> 20	53.16	59.60	X-53.16	66.10
<sup>B)</sup> 180	50		390	60	<sup>A)</sup> 20	53.18	64.50	X-53.18	71.00
<sup>B)</sup> 200	50		450	60	<sup>A)</sup> 20	53.20	69.00	X-53.20	75.50
250	50		495	60	25	53.25	120.30	---	---
300	60		700	60	30	53.30	151.90	---	---

A) EGALEMENT AVEC ALÉSAGE DE 25mm / AUCHT MIT BOHRUNG 25mm / ANCHE CON FORO MOZZO 25mm

B) EGALEMENT AVEC ROULEMENT A BILLES EN INOX +CHF 16.00 / AUCH MIT KUGELLAGER AUS ROSTFREI +CHF 16.00 / ANCHE CON CUSCINETTO A SFERE IN INOX +CHF 16.00

## Secteurs / Bereiche / Settori

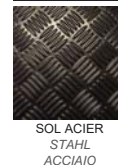

## Variantes / Varianten / Varianti

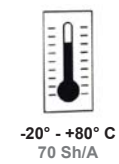

## Roues / Räder / Ruote



Grande elasticità, Charge admissible élevée, Roulement souple et silencieux  
Hohe Elastizität, Hohe Tragfähigkeit, Geräuscharmer Lauf  
Grande elasticità, Carico ammissibile elevato, Rotolamento flessibile e calmo

ROUE À PALIER LISSE, ROULEMENT À ROULEAUX OU À BILLES

RAD MIT GLEITLAGER, ROLLENLAGER ODER KUGELLAGER

RUOTA A FORO LISCIO, SU CUSCINETTO A RULLI E A SFERE

80 – 100 kg

**PNEU-SOFT**

Roue à Pneu plein en Polyuréthane-SOFT, gris, roue avec roulement à rouleaux ou à billes, non-tachant, silencieux, extra-souple, corps/roue: Nylon renforcé de fibres de verre

EXTRA-SOUPLE ET INCREVABLE - NON-TACHANT

**SOFT-REIFEN**

Rad mit Vollreifen aus Polyurethan-SOFT, grau, Rad mit Rollenlager oder Kugellager, spurfrei, Laufruhe, extra-weich Radkörper: Nylon und Glasfaser Verbindung

EXTRA-WEICH UND PANNENSICHER - SPURFREI

**PNEUMATICHE-SOFT**

Pneumatica Piena in Poliuretano-SOFT, grigia, ruota su cuscinetti a rulli e a sfere, antitraccia, silenziosa, grande elasticità, corpo centrale: Nylon rinforzato con fibre di vetro

GRANDE ELASTICITÀ ED A PROVA DI FORATURA

SERIE 'MEDIA' >> Transport							Art. N :	CHF sans TVA	Art. N :	CHF sans TVA	Art. N :	CHF sans TVA	Art. N :	CHF sans TVA	Art. N :	CHF sans TVA
A)	100	30		80	35	8	SOF 10x30	41.30	---	---	---	---	---	---	---	---
A)	125	30		80	35	8	SOF 12x30	43.90	---	---	---	---	---	---	---	---
	150	32		80	50	8	SOF 15x32	25.10	---	---	---	---	X-SOF 15x32	25.10	---	---
	200	32		80	50	8	SOF 20x32	33.80	---	---	---	---	X-SOF 20x32	33.80	---	---
	175	40		90	50 (60)	12 (8)	DCK 17x45	37.20	---	---	---	---	X-DCK 17x45	42.30	---	---
	200	50		100	60	20	---	---	DCR 20x50	38.00	---	---	X-DCR 20x50	43.10	---	---
	200	50		100	50 (60)	12 (8)	---	---	DCK 20x50	42.10	---	---	X-DCK 20x50	47.30	---	---
	305	40		100	45	12	SOF 305x40	82.80	---	---	---	---	X-SOF 305x40	82.80	---	---
24" x 1 3/8	615	32		100	60	12	---	---	---	---	SOF 615x32	113.70	SOF-P.615	62.80	X-SOF 615x32	118.80

A) JANTE A RAYON, GRIS / SPEICHEN-FELGE, GRAU / CORPO CON RAZZE, GRIGIA

RABAIS SPÉCIAL 'SET-CHAISE ROULANTE' PAGE 3.13 / SPEZIAL-RABATT 'SET-ROLLSTUHL' SEITE 3.13 / SCONTO SPECIALE 'SET-CARROZZINE' PAGINA 3.13

100 – 350 kg

**PNEUMATIQUE**

Roue à pneumatique, gris ou noir, roue avec roulement à rouleaux, extra-souple, profil à crampons/rainures corps/roue: Polyamide ou en tôle d'acier zinguée

EXTRA-SOUPLE, GRIS - NON-TACHANT

**LUFT-REIFEN**

Rad mit Luftreifen, grau oder schwarz, Rad mit Rollenlager Laufruhe, extra-weich, Blockprofil/Rillenprofil Radkörper: Polyamid oder mit Stahl-Felge Glanzverzinkt

EXTRA-WEICH, GRAU - SPURFREI

**PNEUMATICHE**

Ruota in Pneumatica, grigia o nera, ruota su cuscinetti a rulli, silenziosa, grande elasticità, profili a scolpita/rigato corpo centrale: Poliamide o dischi in acciaio zincato

GRANDE ELASTICITÀ, GRIGIA - ANTITRACCIA

C) PROFIL A CRAMPONS / BLOCKPROFIL / PROFILI SCOLPITA							R) PROFIL A RAINURES / RILLENPROFIL / PROFILI RIGATO				S) CHAMBRE A AIR / LUFTSCHLAUSCH / CAMERA D'ARIA							
SERIE 'MEDIA' >> Transport							Art. N :	CHF sans TVA	Art. N :	CHF sans TVA	Art. N :	CHF sans TVA	Art. N :	CHF sans TVA	Art. N :	CHF sans TVA		
200	50		100	60	20	82.20-P	48.40	R	---	---	8-P.20 (7 x 1 3/4)	22.50	8-S.20	11.10	S	X-82.20-P	53.10	
260	85		200	75	20	---	---	---	82.26-P	49.80	C	---	8-P.26 (3.00-4)	29.30	S	---	---	
260	85		200	75	20	---	---	---	---	---	82.26-M	56.00	C	8-P.26 (3.00-4)	29.30	S	8-S.26 (4.10/3.50-4)	14.00
260	85		200	60	20	---	---	---	---	---	83.26-M	63.70	C	8-P.26 (3.00-4)	29.30	S	8-S.26 (4.10/3.50-4)	14.00
400	100		200	85	20	---	---	---	82.40-P	78.20	R	---	8-P.40 (4.80/4.00-8)	30.90	S	---	---	
400	100		350	88	25	---	---	---	---	---	83.40-M	109.30	C	8-P.40 (4.80/4.00-8)	30.90	S	8-S.40 (3.50/4.00-8)	15.20
A)	260	85		180	75	20	---	---	82.26-PLEIN	57.60	C	---	---	---	---	---	---	
A)	400	100		180	75	25	---	---	82.40-PLEIN	90.90	R	---	---	---	---	---	---	

A) AVEC PNEU-PLEIN, INCREVABLE / MIT VOLLREIFEN, PANNENSICHER / CON PNEUMATICA PIENA, A PROVA DI FORATURA



GOUDRON ASPHALT ASPALTO

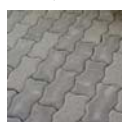

PAVE PFLASTER-STEIN PAVIMENTO



GRILLE GITTER GRIGLIATO



GAZON RASEN ERBA

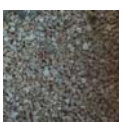

GRAVILLON SPLITT STERRATO

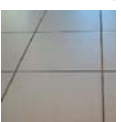

CARRELAGE FLIESEN PIASTRELLE



-20° - +70° C 50-60 Sh/A



SERIE H. PAGE 3.11 120 kg



SERIE 5...8... PAGE 5.9-10 120 - 200 kg



SERIE 5...8... PAGE 5.10 140-200 kg

SET -25%

RABAIS / RABATT / SCONTO : 20% dès/ab/da 100.-- (CHF) / 25% dès/ab/da 500.-- (CHF)

RABAIS DE QUANTITE SUR DEMANDE !

MENGENRABATT AUF ANFRAGE !

SCONTO DI QUANTITA SU RICHIESTA !



60 – 490 kg

## POLYURÉTHANE

Roue Polyuréthane injecté, gris, roue avec roulement à billes, non-tachant, silencieux, résistant aux huiles, graisses et essences...corps/roue: Nylon 6 renforcé de fibres de verre

RECOMMANDÉ POUR LES INDUSTRIES ET LES AGENCEMENTS

## POLYURETHAN

Rad mit Spritzguss-Polyurethan, grau, Rad mit Kugellager spurfrei, Laufruhe, Beständigkeit gegen Öl/Fett/Benzin... Radkörper: Nylon 6 und Glasfaser Verbindung

EMPFOHLEN FÜR INDUSTRIE UND DIE EINRICHTUNGEN

## POLIURETANO

Ruota rivestimento in Poliuretano iniettato, grigia, ruota su cuscinetti a sfere, antitraccia, silenziosa, resistendo agli oli/grassi/petroli... corpo centrale: Nylon 6 rinforzato con fibra di vetro

RACCOMANDATÒ PER INDUSTRIA E PER ARREDAMENTO

mm						Page 1.6	kg	mm	mm	Art. N :	Prix Preis Prezzo	CHF sans TVA	Art. N :	Prix Preis Prezzo	CHF sans TVA
<b>SERIE 'LEGER' &gt;&gt;Appareil</b>													<b>2RS (INOX)</b>		
A)	<b>50</b>	19		<b>60</b>	22	6	<b>73.05x19</b>	9.20		---					
	<b>60</b>	25		<b>70</b>	32	6	<b>73.06x25</b>	12.00		<b>X-73.06x25</b>	12.00				
	<b>75</b>	25		<b>80</b>	28	6	<b>73.07x25</b>	14.60		---					
	<b>80</b>	25		<b>90</b>	32	8	<b>73.08x25</b>	14.20		<b>X-73.08x25</b>	14.20				
	<b>100</b>	25		<b>100</b>	32	8	<b>73.10x25</b>	16.10		<b>X-73.10x25</b>	16.10				
	<b>125</b>	25		<b>110</b>	32	8	<b>73.12x25</b>	19.90		<b>X-73.12x25</b>	19.90				
<b>SERIE 'MEDIA' &gt;&gt;Hôpital-Transport</b>													<b>2RS (INOX)</b>		
	<b>80</b>	32		<b>110</b>	38 (42)	8	<b>73.08x32</b>	15.50		<b>X-73.08x32</b>	15.50				
	<b>100</b>	32		<b>120</b>	38 (42)	8	<b>73.10x32</b>	19.40		<b>X-73.10x32</b>	19.40				
	<b>125</b>	32		<b>120</b>	38 (50)	8 (10)	<b>73.12x32</b>	22.30		<b>X-73.12x32</b>	22.30				
	<b>150</b>	32		<b>160</b>	39 (34)	8 (12)	<b>73.15x32</b>	38.60		<b>X-73.15x32</b>	38.60				
	<b>200</b>	32		<b>180</b>	39 (34)	8 (12)	<b>73.20x32</b>	54.80		<b>X-73.20x32</b>	54.80				
<b>SERIE 'FORT' &gt;Transport-Industrie</b>													<b>INOX</b>		
A)	<b>125</b>	46		<b>390</b>	B) 50 (60)	20 (12)	<b>76.12x46</b>	32.30		<b>X-76.12x46</b>	50.30				
A)	<b>160</b>	46		<b>460</b>	B) 50 (60)	20 (12)	<b>76.16x46</b>	43.00		<b>X-76.16x46</b>	61.00				
A)	<b>200</b>	50		<b>490</b>	B) 50 (60)	20 (12)	<b>76.20x50</b>	57.60		<b>X-76.20x50</b>	75.60				

A) ROUE SANS PARE-FILS / RAD OHNE FADENSCHUTZ / RUOTA SENZA PARAFILI

B) EGALEMENT AVEC MOYEU 60/12mm +CHF 6.00, EN INOX +CHF 9.00 / AUCH MIT NABENLANGE 60/12mm +CHF 6.00, AUS ROSTFREI +CHF 9.00 / ANCHE CON MOZZO 60/12mm +CHF 6.00, IN INOX +CHF 9.00

## Secteurs / Bereiche / Settori



HUILE/ESSENCE  
OEL/BENZIN  
OLIV/PETROLI



USINE  
FABRIK  
INDUSTRIA

## Applications / Anwendung / Applicazioni

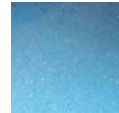

INDUSTRIE  
INDUSTRIE  
INDUSTRIA



PARQUET BOIS  
HOLZ-PARKETT  
PARQUET



TAPIS  
TEPPICH  
MOQUETTE

## Variantes / Varianten / Varianti



-25° - +80° C  
85 Sh/A



SERIE 2..-3..  
PAGE 3.5  
60 – 120 kg



SERIE H..  
PAGE 3.12  
100 – 120 kg



SERIE 55..  
PAGE 4.4  
350 – 490 kg



SERIE 9..-TH..  
PAGE 6.3  
390 – 950 kg

## Roues / Räder / Ruote



**NON-TACHANT.** N'abîme pas les sols, Roulement souple et silencieux, Ne nécessite aucun entretien

**SPURFREI.** Bodenschonend, Geräuscharmer Lauf, Wartungsfrei

**NON MACCHIANDO.** Non danneggia il suolo, Rotolamento flessibile e calmo  
Non richiede alcun'intervista

RABAIS SPÉCIAL 'SET-LIT' (HÔPITAL) PAGE 3.13 / SPEZIAL-RABATT 'SET-BETT' (SPITAL) SEITE 3.13 / SCONTO SPECIALE 'SET-LETTI' (OSPEDALE) PAGINA 3.13



PAGE / SEITE / PAGINA 7.1



PAGE / SEITE / PAGINA 7.6



PAGE / SEITE / PAG. 7.1+7.8



PAGE / SEITE / PAGINA 7.3



PAGE / SEITE / PAGINA 7.1-15



60 – 490 kg

**POLYURÉTHANE-ANTISTATIQUE**

Roue Polyuréthane injecté, gris, roue avec roulement à billes, non-tachant, silencieux, résistant aux huiles, graisses et essences...corps/roue: Nylon 6 renforcé de fibres de verre

AVEC ROUES ANTISTATIQUES, RECOMMANDÉ POUR LES HÔPITAUX ET L'INDUSTRIE

**POLYURETHAN-ANTISTATISCH**

Rad mit Spritzguss-Polyurethan, grau, Rad mit Kugellager spurfrei, Laufruhe, Beständigkeit gegen Öl/Fett/Benzin... Radkörper: Nylon 6 und Glasfaser Verbindung

MIT ANTISTATISCH-RÄDERN, EMPFOHLEN FÜR SPITÄLER UND INDUSTRIE

**POLIURETANO-ANTISTATICO**

Ruota rivestimento in Poliuretano iniettato, grigia, ruota su cuscinetti a sfere, antitraccia, silenziosa, resistendo agli oli/grassi/petrol... corpo centrale: Nylon 6 rinforzato con fibra di vetro

CON ANTISTATICO-RUOTE, RACCOMANDATO PER OSPEDALI ED INDUSTRIA

mm						Page 1.6		kg		mm		mm		Art. N :		Prix Preis Prezzo	
SERIE 'LEGER' >>Appareil												2RS (INOX)					
A)	50	19	60	22	6	73.05x19-A	13.40					---					
	60	25	70	32	6	73.06x25-A	14.20					X-73.06x25-A	14.20				
	75	25	80	28	6	73.07x25-A	19.60					---					
	80	25	90	32	8	73.08x25-A	18.40					X-73.08x25-A	18.40				
	100	25	100	32	8	73.10x25-A	24.20					X-73.10x25-A	24.20				
	125	25	110	32	8	73.12x25-A	34.50					X-73.12x25-A	34.50				
SERIE 'MEDIA' >>Hôpital-Transport												2RS (INOX)					
	80	32	120	38 (42)	8	73.08x32-A	22.80					X-73.08x32-A	22.80				
	100	32	130	38 (42)	8	73.10x32-A	29.20					X-73.10x32-A	29.20				
	125	32	130	38 (50)	8 (10)	73.12x32-A	36.70					X-73.12x32-A	36.70				
	150	32	160	39 (34)	8 (12)	73.15x32-A	56.40					X-73.15x32-A	56.40				
	200	32	180	39 (34)	8 (12)	73.20x32-A	72.50					X-73.20x32-A	72.50				
SERIE 'FORT' >Transport-Industrie												INOX					
A)	125	46	390	B) 50 (60)	20 (12)	76.12x46-A	53.90					X-76.12x46-A	70.60				
A)	160	46	460	B) 50 (60)	20 (12)	76.16x46-A	71.50					X-76.16x46-A	89.50				
A)	200	50	490	B) 50 (60)	20 (12)	76.20x50-A	103.60					X-76.20x50-A	121.60				

A) ROUE SANS PARE-FILES / RAD OHNE FADENSCHUTZ / RUOTA SENZA PARAFILI

B) ÉGALEMENT AVEC MOYEU 60/12mm +CHF 6.00, EN INOX +CHF 9.00 / AUCH MIT NABENLANGE 60/12mm +CHF 6.00, AUS ROSTFREI +CHF 9.00 / ANCHE CON MOZZO 60/12mm +CHF 6.00, IN INOX +CHF 9.00

## Secteurs / Bereiche / Settori

## Applications / Anwendung / Applicazioni



HUILE/ESSENCE  
ÖL/BENZIN  
OLI/PETROLI



HOPITAL  
SPITAL  
HOSPITAL



ANTISTATIQUE  
ANTISTATISCH  
ANTISTATICO



INDUSTRIE  
INDUSTRIE  
INDUSTRIA

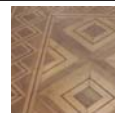

PARQUET BOIS  
HOLZ-PARKETT  
PARQUET

## Variantes / Varianten / Varianti



-25° - +80° C  
87 Sh/A



SERIE 2..-3..  
PAGE 3.6  
60 – 120 kg



SERIE H..  
PAGE 3.12  
100 – 120 kg



SERIE 5..-8..  
PAGE 5.13-14  
120 – 480 kg



SERIE 9..-TH..  
PAGE 6.4  
390 – 950 kg

## Roues / Räder / Ruote



**NON-TACHANT ET ANTISTATIQUE, N'abîme pas les sols, Roulement souple et silencieux, Ne nécessite aucun entretien**

**SPURFREI UND ANTISTATISCH, Bodenschonend, Geräuscharmer Lauf, Wartungsfrei**

**NON MACCHIANDO E ANTISTATICO, Non danneggia il suolo, Rotolamento flessibile e calmo, Non richiede alcun'intervista**

RABAIS SPÉCIAL 'SET-LIT' (HÔPITAL) PAGE 3.13 / SPEZIAL-RABATT 'SET-BETT' (SPITAL) SEITE 3.13 / SCONTO SPECIALE 'SET-LETTI' (OSPEDALE) PAGINA 3.13



PAGE / SEITE / PAGINA 7.9



PAGE / SEITE / PAGINA 7.1-2



PAGE / SEITE / PAGINA 7.8



PAGE / SEITE / PAGINA 7.12



PAGE / SEITE / PAGINA 7.1-15

**RABAIS / RABATT / SCONTO : 20% dès/ab/da 100.-- (CHF) / 25% dès/ab/da 500.-- (CHF)**  
RABAIS DE QUANTITE SUR DEMANDE ! MENGENRABATT AUF ANFRAGE ! SCONTO DI QUANTITA SU RICHIESTA !

80 – 290 kg

**POLYURÉTHANE**

Roue Polyuréthane injecté, rouge/brun, roue à palier lisse ou avec roulement à rouleaux, non-tachant, corps/roue: Nylon 6

RÉSISTANT AUX HUILES/GRAISSES/ESSENCES...

**POLYURETHAN**

Rad mit Spritzguss-Polyurethan, rot/braun, Rad mit Gleitlager oder Rollenlager, spurfrei Radkörper: Nylon 6

BESTÄNDIGKEIT GEGEN OEL/FETT/BENZIN...

**POLIURETANO**

Ruota rivestimento in Poliuretano iniettato, rosso/marrone ruota a foro liscio e su cuscinetti a rulli, antitraccia, corpo centrale: Nylon 6

RESISTENDO AGLI OLI/GRASSI/PETROLI...

mm	mm	Page 1.6	kg	mm	mm	Art. N :	Prix Preis Prezzo	CHF sans TVA	Art. N :	Prix Preis Prezzo	CHF sans TVA
<b>SERIE 'MEDIA' &gt;&gt;Transport-Machine</b>									<b>INOX</b>		
50	19		80	22	8	71.05x19	3.40		X-71.05x19	3.40	
80	30		170	40	12	71.08x30	9.20		X-71.08x30	9.20	
80	30		200	40	12	72.08x30	11.30		X-72.08x30	15.20	
100	30		270	40	12	72.10x30	13.70		X-72.10x30	17.50	
125	30		290	50	15	72.12x30	15.50		X-72.12x30	19.40	

**Secteurs / Bereiche / Settori**

HUILE/ESSENCE  
OEL/BENZIN  
OLI/PETROLI

**Applications / Anwendung / Applicazioni**

USINE  
FABRIK  
INDUSTRIA



GOUDRON  
ASPHALT  
ASFALTO



INDUSTRIE  
INDUSTRIE  
INDUSTRIA



BETON  
BETON  
CEMENTO

**Variantes / Varianten / Varianti**

-30° - +80° C  
94 Sh/A



SERIE 2...3..  
PAGE 3.4  
50 – 120 kg



SERIE 55..  
PAGE 4.5  
210 – 280 kg



SERIE 5...7..  
PAGE 5.15  
120 - 280 kg

**Roues / Räder / Ruote**

Résistant aux huiles et à l'usure, Ne nécessite aucun entretien, Charge admissible élevée

Oelbeständig, Wartungsfrei, Hohe Tragfähigkeit, Gute Verschleissfestigkeit

Resistendo agli oli ed all'usura, Non richiede alcun'intervista, Carico ammissibile elevato

550 – 950 kg

**POLYURÉTHANE**

Roue Polyuréthane injecté, rouge/brun, roue avec roulement à billes, non-tachant, corps/roue : Nylon 6 renforcé de fibres de verre

RÉSISTANT AUX HUILES/GRAISSES/ESSENCES...

**POLYURETHAN**

Rad mit Spritzguss-Polyurethan, rot/braun, Rad mit Kugellager, spurfrei Radkörper: Nylon 6 und Glasfaser Verbindung

BESTÄNDIGKEIT GEGEN OEL/FETT/BENZIN...

**POLIURETANO**

Ruota rivestimento in Poliuretano iniettato, rosso/marrone ruota su cuscinetti a sfere, antitraccia, corpo centrale: Nylon 6 rinforzato con fibra di vetro

RESISTENDO AGLI OLI/GRASSI/PETROLI...

mm	mm	Page 1.6	kg	mm	mm	Art. N :	Prix Preis Prezzo	CHF sans TVA	Art. N :	Prix Preis Prezzo	CHF sans TVA
<b>SERIE 'FORT' &gt;&gt;Transport-Industrie</b>									<b>INOX</b>		
A) 125	46		550	B) 50 (60)	20 (12)	776.12x46	37.20		X-776.12x46	55.20	
A) 160	46		650	B) 50 (60)	20 (12)	776.16x46	48.90		X-776.16x46	67.00	
A) 200	50		900	B) 50 (60)	20 (12)	776.20x50	65.30		X-776.20x50	83.30	

A) ROUE SANS PARE-FILS / RAD OHNE FADENSCHUTZ / RUOTA SENZA PARAFILI  
B) EGALEMENT AVEC MOYEU 60/12mm +CHF 6.00, EN INOX +CHF 9.00 / AUCH MIT NABENLANGE 60/12mm +CHF 6.00, AUS ROSTFREI +CHF 9.00 / ANCHE CON MOZZO 60/12mm +CHF 6.00, IN INOX +CHF 9.00

**Secteurs / Bereiche / Settori**

HUILE/ESSENCE  
OEL/BENZIN  
OLI/PETROLI

**Applications / Anwendung / Applicazioni**

USINE  
FABRIK  
INDUSTRIA



GOUDRON  
ASPHALT  
ASFALTO



INDUSTRIE  
INDUSTRIE  
INDUSTRIA



BETON  
BETON  
CEMENTO

**Variantes / Varianten / Varianti**

-30° - +80° C  
94 Sh/A



SERIE 55  
PAGE 4.5  
350 – 500 kg



SERIE 5...8..  
PAGE 5.16  
350 – 480 kg



SERIE 9..  
PAGE 6.5  
550 – 850 kg



SERIE TH..  
PAGE 6.5  
1100 - 1600 kg

**Roues / Räder / Ruote**

Bonne résistance à l'usure, aux chocs et aux huiles/grasses/essences..., Ne nécessite aucun entretien, Charge admissible très élevée

Gute Beständigkeit gegen Abrieb, Schlagbelastungen und Oel/Fett/Benzin..., Wartungsfrei, Hohe Tragfähigkeit, Gute Verschleissfestigkeit

Resistendo all'usura, agli scosse ed oli/grassi/petrol..., Non richiede alcun'intervista, Carico ammissibile elevato

250 – 4500 kg

**POLYURÉTHANE**

Roue Polyuréthane **ADIPRENE**, rouge/brun, roue avec roulement à billes, non-tachant., silencieux corps/roue: Fonte

RÉSISTANT AUX HUILES/GRAISSES/ESSENCES...

**POLYURETHAN**

Polyurethanrad **ADIPREN**, rot/braun, Rad mit Kugellager, spurfrei, Laufruhe Radkörper: Guss

BESTÄNDIGKEIT GEGEN OEL/FETT/BENZIN...

**POLIURETANO**

Ruota in Poliuretano **ADIPRENE**, rosso-marrone ruota su cuscinetti a sfere, antitraccia, silenziosa corpo centrale: Ghisa

RESISTENDO AGLI OLI/GRASSI/PETROLI...

mm	mm	Page 1.6	kg	mm	mm	Art. N :	Prix Preis Prezzo
<b>SERIE 'EXTRA' &gt;&gt;Transport-Industrie</b>							
80	30		250	41 (29)	8 (12)	93.08x30	38.60
100	30		300	41 (34)	8 (12)	93.10x30	39.50
100	40		390	41 (30)	8 (15)	93.10x40	46.70
125	50		750	50	20	93.12x50	95.50
150	50		950	50	20	93.15x50	104.40
200	50		1200	50	20	93.20x50	101.80
250	60		1600	60	25	93.25x60	201.30
300	70		2300	70	30	93.30x70	259.40
<b>SERIE 'MAXI' &gt;&gt;Machine-Industrie</b>							
200	100		2000	100	30	93.20x100	405.60
250	100		2200	100	35	93.25x100	292.80
300	100		2800	100	35	93.30x100	409.40
400	100		3800	100	40	93.40x100	825.30
500	110		4500	110	40	93.50x110	1528.40

## Secteurs / Bereiche / Settori



HUILE/ESSENCE  
OEL/BENZIN  
OLI/PETROLI



USINE  
FABRIK  
INDUSTRIA

## Applications / Anwendung / Applicazioni



GOUDRON  
ASPHALT  
ASFALTO



INDUSTRIE  
INDUSTRIE  
INDUSTRIA



BETON  
BETON  
CEMENTO

## Variantes / Varianten / Varianti



-30° - +70° C  
92 Sh/A



SERIE 55..  
PAGE 4.4  
300 – 500 kg



SERIE 9..  
PAGE 6.6  
480 – 1500 kg



SERIE TH..  
PAGE 6.6  
1400 – 2400 kg

## Roues / Räder / Ruote



Très bonne résistance à l'usure, aux chocs et aux huiles/grasses/essences..., Charge très élevée, Roulement silencieux, Faible résistance au roulement

Sehr gute Beständigkeit gegen Abrieb, Schlagbelastungen und Oel/Fett/Benzin..., Hohe Tragfähigkeit, Geräuscharmer Lauf, Geringer Anfahrwiderstand

Molto resistente all'usura, agli scosse ed oli/grassi/petrol..., Carico molto elevato, Rotolamento calmo, Debole resistenza al rotolamento

AUTRES GRANDEURS DISPONIBLES / ANDERE VERFÜGBAREN GRÖßEN / ALTRE DIMENSIONI DISPONIBILI



PAGE / SEITE / PAG. 7.5+7.13



PAGE / SEITE / PAGINA 7.5



PAGE / SEITE / PAGINA 7.1+7.8



PAGE / SEITE / PAGINA 7.10-11



PAGE / SEITE / PAGINA 7.6

**RABAIS / RABATT / SCONTO : 20% dès/ab/da 100.-- (CHF) / 25% dès/ab/da 500.-- (CHF)**  
RABAIS DE QUANTITE SUR DEMANDE ! MENGENRABATT AUF ANFRAGE ! SCONTO DI QUANTITA SU RICHIESTA !



600 – 4000 kg

## POLYURÉTHANE

Roue Polyuréthane **VULKOLLAN**, rouge/brun, roue avec roulement à billes, non-tachant,, silencieux corps/roue: Fonte

RÉSISTANT AUX HUILES/GRAISSES/ESSENCES...

## POLYURETHAN

Polyurethanrad **VULKOLLAN**, rot/braun, Rad mit Kugellager, spurfrei, Laufruhe Radkörper: Guss

BESTÄNDIGKEIT GEGEN OEL/FETT/BENZIN...

## POLIURETANO

Ruota in Poliuretano **VULKOLLAN**, rosso-marrone ruota su cuscinetti a sfere, antitraccia, silenziosa corpo centrale: Ghisa

RESISTENDO AGLI OLII/GRASSI/PETROLI...

mm	mm	Page 1.6	kg	mm	mm	Art. N :	Prix Preis Prezzo	CHF sans TVA
<b>SERIE 'EXTRA' &gt;&gt;Transport-Industrie</b>								
125	38		600	60	20	65 PTR	97.00	
125	38		650	57	20	65 PTK	126.60	
150	38		950	60	20	66 PTR	107.30	
150	38		1000	57	20	66 PTK	137.50	
200	45		1400	60	20	68 PTR	164.80	
200	45		1500	57	20	68 PTK	190.80	
250	45		1600	57	25	610 PTK	269.60	
300	45		1700	57	25	612 PTK	349.10	
<b>SERIE 'MAXI' &gt;&gt;Machine-Industrie</b>								
200	75		2600	83	25	88 PTK	371.30	
250	75		2800	83	25	810 PTK	466.00	
250	75		3000	83	25	810 PTS	483.60	
300	75		4000	83	25	812 PTTS	720.00	

## Secteurs / Bereiche / Settori



HUILE/ESSENCE  
OEL/BENZIN  
OLII/PETROLI



USINE  
FABRIK  
INDUSTRIA

## Applications / Anwendung / Applicazioni



GOUDRON  
ASPHALT  
ASFALTO



INDUSTRIE  
INDUSTRIE  
INDUSTRIA



BETON  
BETON  
CEMENTO

## Variantes / Varianten / Varianti



-35° - +75° C  
92 Sh/A



SERIE TH..  
PAGE 6.7  
700 – 1600 kg



SERIE WP..  
PAGE 6.8  
2600 – 2800 kg



SERIE LT/TW..  
PAGE 6.8  
3000 – 6500 kg

## Roues / Räder / Ruote



Très bonne résistance à l'usure, aux chocs et aux huiles/grasses/essences..., Charge très élevée, Roulement silencieux, Faible résistance au roulement

Sehr gute Beständigkeit gegen Abrieb, Schlagbelastungen und Oel/Fett/Benzin..., Hohe Tragfähigkeit, Geräuscharmer Lauf, Geringer Anfahrwiderstand

Molto resistendo all'usura, agli scosse ed oli/grassi/petroli..., Carico molto elevato, Rotolamento calmo, Debole resistenza al rotolamento

AUTRES GRANDEURS DISPONIBLES / ANDERE VERFÜGBAREN GRÖßEN / ALTRE DIMENSIONI DISPONIBILI



PAGE / SEITE / PAGINA 7.9



PAGE / SEITE / PAGINA 7.14



PAGE / SEITE / PAG. 7.4+7.11



PAGE / SEITE / PAGINA 7.1



PAGE / SEITE / PAGINA 7.1-15

**ROUES-ACCESSOIRES-SYSTÈMES DE FIXATIONS**

**RÄDER-ZUBEHÖR-BEFESTIGUNGSSYSTEM**

**RUOTE-ACCESSORI-SISTEMI DI FISSAZIONI**

ROUE À PALIER LISSE, ROULEMENT À ROULEAUX OU À BILLES

RAD MIT GLEITLAGER, ROLLENLAGER ODER KUGELLAGER

RUOTA A FORO LISCIO, SU CUSCINETTO A RULLI E A SFERE

**290 – 2500 kg**

**FONTE**

Roue en Fonte pleine, gris, roue avec roulement à rouleaux, surface de roulement bombée corps/roue: Fonte

RÉSISTANT AUX HUILES/GRAISSES/ESSENCES...

**GUSS**

Guss-Rad, Vollscheibe, grau, Rad mit Rollenlager gewölbte Lauffläche Radkörper: Guss

BESTÄNDIGKEIT GEGEN OEL/FETT/BENZIN...

**GHISA**

Ruota in Ghisa, piena, grigia, ruota su cuscinetti a rulli, superficie di rotolamento convessa corpo centrale: Ghisa

RESISTENDO AGLI OLI/GRASSI/PETROLI...

mm	mm	Page 1.6	kg	mm	mm	Art. N :	Prix Preis Prezzo
<b>SERIE 'MAXI' &gt;&gt;Machine-Industrie</b>							
100	38		400	45	12	44 CIR	36.00
125	38		650	45	12	45 CIR	44.50
125	45		900	60	20	65 CIR	65.20
150	45		1200	60	20	66 CIR	72.90
200	45		2000	60	20	68 CIR	105.30
250	55		2500	60	25	610 CIR	166.30

**Secteurs / Bereiche / Settori**



HUILE/ESSENCE  
OEL/BENZIN  
OLI/PETROLI

**Applications / Anwendung / Applicazioni**



USINE  
FABRIK  
INDUSTRIA



CHALEUR  
HITZEBESTÄNDIG  
ALTE TEMPERAT.

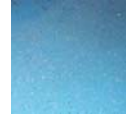

INDUSTRIE  
INDUSTRIE  
INDUSTRIA



BETON  
BETON  
CEMENTO

**Variantes / Varianten / Varianti**



-40° - +340° C  
FONTE



SERIE 55..  
PAGE 4.6  
230 - 320 kg



SERIE TH..  
PAGE 8.11  
900 - 2200 kg



SERIE TH/TW..  
PAGE 6.11  
1800 - 2700 kg

**Roues / Räder / Ruote**



**AUTRES GRANDEURS DISPONIBLES / ANDERE VERFÜGBAREN GRÖßEN / ALTRE DIMENSIONI DISPONIBILI**

Charge très élevée, Résistant aux chocs, Ne nécessite aucun entretien, Très bonne résistance à l'usure

Hohe Tragfähigkeit, Stossunempfindlich, Wartungsfrei, Sehr gute Verschleissfestigkeit

Carico molto elevato, Resistente alle scosse, Non richiede alcun'intervista molto Buona resistenza all'usura

**200 – 500 kg**

**ROUE CHALEUR**

Roue en Résine de Phénol, noir, roue à palier lisse, non-tachant corps/roue: Résine de Phénol

RECOMMANDÉ POUR LES BOULANGERIES ET L'INDUSTRIE

**HITZEBESTÄNDIG**

Rad aus Phenolharz, schwarz, Rad mit Gleitlager, spurfrei Radkörper: Phenolharz

EMPFOHLEN FÜR BÄCKEREI UND INDUSTRIE

**ALTE TEMPERATURE**

Ruota in Resina Fenolica, nero, ruota a foro liscio, antitraccia corpo centrale: Resina Fenolica

RACCOMANDATÒ PER PANETTERIE ED INDUSTRIA

mm	mm	Page 1.6	kg	mm	mm	Art. N :	Prix Preis Prezzo
<b>SERIE 'FORT' &gt;&gt;Transport-Industrie</b>							
80	35		200	38	12	69.08x35	21.40
100	35		250	38	12	69.10x35	25.10
125	40		300	43	20	69.12x40	44.50
150	50		400	60	20	69.15x50	92.50
200	50		500	60	20	69.20x50	117.90
A) 100	30		60	39	12	69.10-S	67.00

A) CAOUTCHOUC-ELASTIQUE ROUGE (80 Sh/A, SILENCIEUX) / ELASTISCH-GUMMI ROT (80 Sh/A, LAUFRIHE) / GOMMA-ELASTICA (80 Sh/A, SILENCIA)

**Secteurs / Bereiche / Settori**



USINE  
FABRIK  
INDUSTRIA

**Applications / Anwendung / Applicazioni**



CUISINE  
KÜCHE  
CUCINA



CHALEUR  
HITZEBESTÄNDIG  
ALTE TEMPERAT.

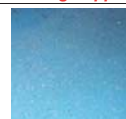

INDUSTRIE  
INDUSTRIE  
INDUSTRIA



BETON  
BETON  
CEMENTO

**Variantes / Varianten / Varianti**



-40° - +280° C  
95 Sh/A



SERIE 5...-8..  
PAGE 5.20  
200 - 480 kg



SERIE 5.\*A)  
PAGE 5.20  
60 kg

**Roues / Räder / Ruote**



Charge très élevée, Résistant aux chocs, Ne nécessite aucun entretien, -40°C à +280°C, Résine de Phénol

Hohe Tragfähigkeit, Stossunempfindlich, Wartungsfrei, -40°C à +280°C, Phenolharz

Carico molto elevato, Resistente alle scosse, Non richiede alcun'intervista -40°C a +280°C, Résine di fenolo

**RABAIS / RABATT / SCONTO : 20% dès/ab/da 100.-- (CHF) / 25% dès/ab/da 500.-- (CHF)**  
RABAIS DE QUANTITE SUR DEMANDE ! MENGENRABATT AUF ANFRAGE ! SCONTO DI QUANTITA SU RICHIESTA !

55 – 400 kg

## POLYAMIDE / NYLON

Roue Polyamide, noir ou blanc, roue à palier lisse, avec roulement à rouleaux ou à billes, non-tachant corps/roue: Polyamide

RÉSISTANT AUX HUILES/GRAISSES/ESSENCES...

## POLYAMID / NYLON

Polyamid-Rad, schwarz oder weiss, Rad mit Gleitlager, Rollenlager oder Kugellager, spurfrei Radkörper: Polyamid

BESTÄNDIGKEIT GEGEN OEL/FETT/BENZIN...

## POLIAMMIDE / NYLON

Ruota in Poliammide, nero e bianco, ruota a foro liscio, su cuscinetti a rulli e a sfere, antitraccia corpo centrale: Poliammide

RESISTENDO AGLI OLI/GRASSI/PETROLI...

mm						Page 1.6	kg	mm	mm	Art. N :	CHF sans TVA	Art. N :	CHF sans TVA
<b>SERIE 'LEGER' &gt;&gt;Appareil</b>													
A)	30	15	35	21	8					61.03x15-N	1.80	X-61.03x15-N	1.80
A)	36	16	40	21	8					61.03x16-N	1.90	X-61.03.16-N	1.90
A)	40	18	50	21	8					61.04x18-N	2.00	X-61.04x18-N	2.00
A)	50	19	90	22	8					61.05x19-N	2.40	X-61.05x19-N	2.40
A)	60	24	70	28	8					61.06x24-N	2.70	X-61.06x24-N	2.70
A)	75	24	75	28	8					61.07x24-N	3.10	X-61.07x24-N	3.10
A)	80	24	80	28	8					61.08x24-N	3.60	X-61.08x24-N	3.60
A)	100	24	90	28	8					61.10x24-N	4.50	X-61.10x24-N	4.50
<b>SERIE 'MEDIA' &gt;&gt;Appareil-Industrie</b>													
A)	75	28	90	34	10					61.07x28-N	3.60	X-61.07x28-N	3.60
A)	80	28	95	34	10					61.08x28-N	4.10	X-61.08x28-N	4.10
A)	100	28	100	34	10					61.10x28-N	5.40	X-61.10x28-N	5.40
A)	125	28	105	34	10					61.12x28-N	8.60	X-61.12x28-N	8.60
<b>SERIE 'FORT' &gt;&gt;Machine-Industrie</b>													
A)	50	35	150	40	12					NN.05	9.10	X-NN.05	9.10
	63	25	120	30	10					NY 325	3.70	X-NY 325	3.70
A)	63	38	180	40	12					NN.06	12.70	X-NN.06	17.80
	75	25	160	30	10					NY 33	5.20	X-NY 33	5.20
	75	35	190	45	12					NY 43	7.60	X-NY 43	7.60
A)	76	46	400	50	15					NN.07	18.90	X-NN.07	24.10
	100	35	300	45	12					44 NYR	13.10	---	
	125	35	320	45	12					45 NYR	17.10	---	
<b>SERIE 'MEDIA' &gt;&gt;Transport-Industrie</b>													
	80	30	130	40	12					61.08x30	4.60	X-61.08x30	4.60
	80	30	180	40	12					62.08x30	8.10	X-62.08x30	12.00
	100	33	150	40	12					61.10x33	5.30	X-61.10x33	5.30
	100	30	260	40	12					62.10x30	10.90	X-62.10x30	14.70
	100	35	350	40	12					63.10x35	32.00	---	
	125	40	200	50	15					61.12x38	8.70	X-61.12x38	8.70
	150	40	250	48	15					61.15x40	12.30	X-61.15x40	12.30
	150	40	280	50	15					62.15x40	17.50	X-62.15x40	21.40

A) ROUE EN POLYAMIDE/NYLON, NOIR / RAD AUS POLYAMID/NYLON, SCHWARZ / RUOTA IN POLIAMMIDE/NYLON, NERA

## Secteurs / Bereiche / Settori



HUILE/ESSENCE  
OEL/BENZIN  
OLI/PETROLI



USINE  
FABRIK  
INDUSTRIA

## Applications / Anwendung / Applicazioni



INDUSTRIE  
INDUSTRIE  
INDUSTRIA



BETON  
BETON  
CEMENTO



TAPIS  
TEPPICH  
MOQUETTE

## Variantes / Varianten / Varianti



-30° - +80° C  
NYLON



SERIE 2..-3..  
PAGE 3.8  
50 – 110 kg



SERIE 34..  
PAGE 4.2  
180 – 600 kg



SERIE 5..-8..  
PAGE 5.17-19  
130 – 480 kg



SERIE 9..-TH..  
PAGE 6.9-10  
700 – 2700 kg

## Roues / Räder / Ruote

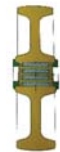

Résistant aux huiles et à l'usure, Ne nécessite aucun entretien, Charge admissible élevée

Oilbeständig, Wartungsfrei, Hohe Tragfähigkeit, Gute Verschleissfestigkeit

Resistendo agli oli ed all'usura, Non richiede alcun'intervista, Carico ammissibile elevato



300 – 2500 kg

**POLYAMIDE / NYLON**

Roue Polyamide, blanc, roue à palier lisse, avec roulement à rouleaux ou à billes, non-tachant corps/roue: Polyamide ou Nylon 6

RÉSISTANT AUX HUILES/GRAISSES/ESSENCES...

**POLYAMID / NYLON**

Polyamid-Rad, weiss, Rad mit Gleitlager, Rollenlager oder Kugellager, spurfrei Radkörper: Polyamid oder Nylon 6

BESTÄNDIGKEIT GEGEN OEL/FETT/BENZIN...

**POLIAMMIDE / NYLON**

Ruota in Poliammide, bianco, ruota a foro liscio, su cuscinetti a rulli e a sfere, antitraccia corpo centrale: Poliammide o Nylon 6

RESISTENDO AGLI OLI/GRASSI/PETROLI...

mm	mm	Page 1.6	kg	mm	mm	Art. N :	Prix CHF sans TVA	Art. N :	Prix CHF sans TVA
<b>SERIE 'FORT' &gt;&gt;Machine-Transport</b>								<b>INOX</b>	
100	40		400	48	15	62.101x40	16.80	---	
125	38		300	50	15	61.121x38	12.80	X-61.121x38	12.80
125	38		350	50	15	62.121x38	17.20	---	
150	43		500	60	20	61.151x43	18.10	X-61.151x43	18.10
150	40		500	60	20	62.151x40	22.10	---	
160	40		300	58	20	61.16x40	14.60	X-61.16x40	14.60
160	40		400	58	20	62.16x40	23.90	X-62.16x40	30.20
160	40		450	58	20	63.16x40	32.50	X-63.16x40	50.80
200	50		400	58	20	61.20x50	27.60	X-61.20x50	27.60
200	50		450	58	20	62.20x50	33.20	X-62.20x50	39.50
200	50		500	50	20	63.20x50	41.80	X-63.20x50	59.80
<b>SERIE 'EXTRA' &gt;&gt;Industrie-Transport</b>								<b>INOX</b>	
A) 125	46		700	B) 50 (60)	20 (12)	66.12x46	33.20	X-66.12x46	51.20
A) 160	46		900	B) 50 (60)	20 (12)	66.16x46	42.30	X-66.16x46	60.40
A) 200	50		1100	B) 50 (60)	20 (12)	66.20x50	56.30	X-66.20x50	74.40
250	58		800	75	25	62.25x58	67.90	---	
250	60		1300	60	25	63.251x60	107.50	X-63.251x60	120.40
<b>SERIE 'MAXI' &gt;&gt;Industrie-Transport</b>									
150	50		1200	60	20	66 NYK	95.90	sur demande auf Anfrage	
200	50		1900	60	25	68 NYK	141.30	sur demande auf Anfrage	
250	60		2500	60	25	610 NYK	226.70	sur demande auf Anfrage	

Secteurs / Bereiche / Settori



Applications / Anwendung / Applicazioni

Variantes / Varianten / Varianti



Roues / Räder / Ruote



Résistant aux huiles et à l'usure, Ne nécessite aucun entretien, Charge admissible élevée

Oelbeständig, Wartungsfrei, Hohe Tragfähigkeit, Gute Verschleissfestigkeit

Resistendo agli oli ed all'usura, Non richiede alcun'intervista, Carico ammissibile elevato

A) ROUE EN NYLON 6, GRIS / RAD AUS NYLON 6, GRAU / RUOTA IN NYLON 6, GRIGIA

ROUE SANS PARE-FILES / RAD OHNE FADENSCHUTZ / RUOTA SENZA PARAFILI

B) EGALEMENT AVEC MOYEU 60/12mm +CHF 6.00, EN INOX +CHF 9.00 / AUCH MIT NABENLANGE 60/12mm +CHF 6.00, AUS ROSTFREI +CHF 9.00 / ANCHE CON MOZZO 60/12mm +CHF 6.00, IN INOX +CHF 9.00



PAGE / SEITE / PAGINA 7.13



PAGE / SEITE / PAGINA 7.1-2



PAGE / SEITE / PAGINA 7.10



PAGE / SEITE / PAGINA 7.3



PAGE / SEITE / PAGINA 7.1-15

**RABAIS / RABATT / SCONTO : 20% dès/ab/da 100.-- (CHF) / 25% dès/ab/da 500.-- (CHF)**  
 RABAIS DE QUANTITE SUR DEMANDE ! MENGENRABATT AUF ANFRAGE ! SCONTO DI QUANTITA SU RICHIESTA !

700 – 800 kg

**POLYAMIDE / NYLON**

Roue Polyamide/Nylon 6, blanc, roue avec roulement à billes non-tachant, résistant aux huiles/grasses/essences... corps/roue: Polyamide/Nylon 6

ROULEAUX DE TRANSPORT POUR TRANSPALETTE

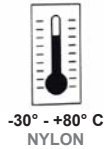
**POLYAMID / NYLON**

Polyamid-Rad/Nylon 6, weiss, Rad mit Kugellager, spurfrei, Beständigkeit gegen Öl/Fett/Benzin... Radkörper: Polyamid/Nylon 6

TRAGROLLEN FÜR PALETTTHUBWAGEN



SERIE 'EXTRA' &gt;&gt;Industrie-Transport

85	70	700	70	A)	20
85	90	800	90	A)	20

**POLIAMMIDE / NYLON**

Ruota in Poliammide/Nylon 6, bianco, ruota su cuscinetti a sfere, antitraccia, resistendo agli oli/grassi/petroli... corpo centrale: Poliammide/Nylon 6

RULLI PER TRANSPALETTE



Prix  
Preis  
Prezzo

Art. N :

CHF  
sans TVA

Prix  
Preis  
Prezzo

Art. N :

CHF  
sans TVA

INOX

X-RNY 87

50.80

X-RNY 89

56.00

**POLYURÉTHANE**

Roue Polyuréthane ADIPRENE, rouge/brun, roue avec roulement à billes, non-tachant, silencieux, résistant aux huiles/grasses/essences..., corps/roue: Fonte

ROULEAUX DE TRANSPORT POUR TRANSPALETTE

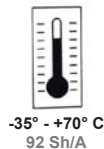
**POLYURETHAN**

Polyurethanrad ADIPREN, rot/braun, Rad mit Kugellager, spurfrei, Laufruhe, Beständigkeit gegen Öl/Fett/Benzin..., Radkörper: Guss

TRAGROLLEN FÜR PALETTTHUBWAGEN



SERIE 'EXTRA' &gt;&gt;Industrie-Transport

85	70	750	70	A)	20
85	90 <td>850</td> <td>90</td> <td>A)</td> <td>20</td>	850	90	A)	20



Prix  
Preis  
Prezzo

Art. N :

CHF  
sans TVA

RPO 87

60.90

RPO 89

73.20

**POLIURETANO**

Ruota in Poliuretano ADIPRENE, rosso-marrone, ruota su cuscinetti a sfere, antitraccia, silenziosa, resistendo agli oli/grassi/petroli..., corpo centrale: Ghisa

RULLI PER TRANSPALETTE

750 – 850 kg

**FONTE**

Roue en Fonte pleine, gris, roue avec roulement à billes surface de roulement bombée, résistant aux huiles, graisses et essences..., corps/roue: Fonte

ROULEAUX DE TRANSPORT POUR TRANSPALETTE

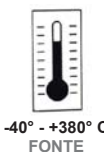
**GUSS**

Guss-Rad, Vollscheibe, grau, Rad mit Kugellager, gewölbte Lauffläche, Beständigkeit gegen Öl/Fett/Benzin... Radkörper: Guss

TRAGROLLEN FÜR PALETTTHUBWAGEN



SERIE 'MAXI' &gt;&gt;Industrie-Transport

85	70	1000	70	A)	20
85	90 <td>1500</td> <td>90</td> <td>A)</td> <td>20</td>	1500	90	A)	20



Prix  
Preis  
Prezzo

Art. N :

CHF  
sans TVA

RST 87

86.00

RST 89

97.10

**GHISA**

Ruota in Ghisa, piena, grigia, ruota su cuscinetti a sfere, superficie di rotolamento convessa, resistendo agli oli/grassi/petroli..., corpo centrale: Ghisa

RULLI PER TRANSPALETTE

1000 – 1500 kg

A) EGALEMENT AVEC ROULEMENT 2RS +CHF 3.00, AVEC ALESAGE 25mm +CHF 6.00 / AUCH MIT KUGELLAGER 2RS +CHF 3.00, MIT BOHRUNG 25mm +CHF 6.00 / ANCHE CON CUSC.SFERE 2RS +CHF 3.00, CON FORO 25mm +CHF 6.00

AUTRES GRANDEURS DISPONIBLES / ANDERE VERFÜGBAREN GRÖßEN / ALTRE DIMENSIONI DISPONIBILI

RABAIS SPÉCIAL 'SET-TRANSPALETTE' PAGE 4.7 / SPEZIAL-RABATT 'SET-PALETTTHUBWAGEN' SEITE 4.7 / SCONTO SPECIALE 'SET-TRANSPALLETTE' PAGINA 4.7

TRANSPALETTE  
PALETTTHUBWAGEN  
TRANSPALLETMANUTENTION  
TRANSPORT  
TRASPORTOGOUDRON  
ASPHALT  
ASFALTOBETON  
BETON  
CEMENTOINDUSTRIE  
INDUSTRIE  
INDUSTRIACARRELAGE  
FLIESEN  
PIASTRELLE

**BILLES PORTEUSES**

Les billes porteuses sont à même de transporter de fortes charges avec un minimum d'effort. La construction des billes permet la rotation libre et instantanée de la sphère de roulement dans toutes les directions. Monture en acier zingué brillant



**KUGELROLLEN**

Beim Einsatz von Kugelrollen können auch schwere Lasten mit minimalem Kraftaufwand bewegt werden. Die Konstruktion der Kugelrollen ermöglicht der Kugel eine freie und unverzögerte Rotation in alle Richtungen. Gehäuse aus glanzverzinktem Stahl

**RULLI SFERICI**

I rulli sferici riescono a muovere anche carichi pesanti con minimo dispendio energetico. Il tipo di costruzione dei rulli sferici permette al rullo una rotazione libera ed immediata in tutte le direzioni. Supporti d'acciaio zincato brillante

						Prix Preis Prezzo		Prix Preis Prezzo	
mm	mm	mm	kg	mm	mm	Art. N :	CHF sans TVA	Art. N :	CHF sans TVA
						<b>ACIER / STAHL</b>		<b>INOX</b>	
<b>15</b>	24	11.5	31	9.5	<b>60</b>	<b>160.15</b>	14.80	sur demande auf Anfrage	
<b>22</b>	36	20.7	45	9.8	<b>160</b>	<b>160.22</b>	19.80	sur demande auf Anfrage	
<b>30</b>	45	23.0	55	13.8	<b>300</b>	<b>160.30</b>	39.60	sur demande auf Anfrage	
						<b>NYLON</b>		<b>INOX</b>	
<b>15</b>	24	11.5	31	9.5	<b>5</b>	<b>163.15</b>	20.00	sur demande auf Anfrage	
<b>30</b>	45	23.0	55	13.8	<b>25</b>	<b>163.30</b>	74.00	sur demande auf Anfrage	
						Prix Preis Prezzo		Prix Preis Prezzo	
mm	mm	mm	kg	mm	mm	Art. N :	CHF sans TVA	Art. N :	CHF sans TVA
						<b>ACIER / STAHL</b>		<b>INOX</b>	
<b>22</b>	33	17.9	45	9.8	<b>120</b>	<b>165.22</b>	19.40	sur demande auf Anfrage	

AUTRES GRANDEURS DISPONIBLES / ANDERE VERFÜGBAREN GRÖßEN / ALTRE DIMENSIONI DISPONIBILI



**RABAIS / RABATT / SCONTO : 20% dès/ab/da 100.-- (CHF) / 25% dès/ab/da 500.-- (CHF)**  
 RABAIS DE QUANTITE SUR DEMANDE ! MENGENRABATT AUF ANFRAGE ! SCONTO DI QUANTITA SU RICHIESTA !



## ROULEMENT À BILLES

Roulement à billes de précisions, ouvert, fermé ou étanche

## KUGELLAGER

Rillenkugellager, Geöffnet, geschlossen oder wasserdicht

## CUSCINETTI A SFERE

Cuscinetto a sfere di precisioni, aperto, chiuso o stagno

mm	mm	mm	Art. N :	CHF sans TVA	Art. N :	CHF sans TVA	Art. N :	CHF sans TVA	Art. N :	CHF sans TVA
<b>SERIE: 600</b>										
<b>Z</b>										
<b>ZZ</b>										
<b>2RS</b>										
<b>INOX</b>										
<b>7</b>	19	6	607 Z <i>sur demande</i>		607 ZZ 9.10		607 2RS 10.10		---	
<b>8</b>	22	7	608 Z <i>sur demande</i>		608 ZZ 9.10		608 2RS 10.10		---	
<b>9</b>	24	7	609 Z <i>sur demande</i>		609 ZZ 9.30		609 2RS 10.30		---	
<b>SERIE: 620</b>										
<b>Z</b>										
<b>ZZ</b>										
<b>2RS</b>										
<b>INOX</b>										
<b>3</b>	10	4	623 Z <i>sur demande</i>		623 ZZ 11.30		623 2RS 11.30		---	
<b>4</b>	13	5	624 Z <i>sur demande</i>		624 ZZ 10.10		624 2RS 10.10		---	
<b>5</b>	16	5	625 Z <i>sur demande</i>		625 ZZ 8.80		625 2RS 10.00		---	
<b>6</b>	19	6	626 Z <i>sur demande</i>		626 ZZ 9.10		626 2RS 10.10		---	
<b>7</b>	22	7	627 Z <i>sur demande</i>		627 ZZ 8.70		627 2RS 9.70		---	
<b>9</b>	26	8	629 Z <i>sur demande</i>		629 ZZ 9.30		629 2RS 10.50		---	
<b>SERIE: 630</b>										
<b>Z</b>										
<b>ZZ</b>										
<b>2RS</b>										
<b>INOX</b>										
<b>4</b>	16	5	634 Z <i>sur demande</i>		634 ZZ 10.00		634 2RS 11.20		---	
<b>5</b>	19	6	635 Z <i>sur demande</i>		635 ZZ 10.10		635 2RS 11.30		---	
<b>SERIE: 6000</b>										
<b>Z</b>										
<b>ZZ</b>										
<b>2RS</b>										
<b>INOX</b>										
<b>10</b>	26	8	6000 Z <i>sur demande</i>		6000 ZZ 9.10		6000 2RS 12.70		---	
<b>12</b>	28	8	6001 Z <i>sur demande</i>		6001 ZZ 10.30		6001 2RS 11.60		---	
<b>15</b>	32	9	6002 Z <i>sur demande</i>		6002 ZZ 11.10		6002 2RS 12.70		---	
<b>17</b>	35	10	6003 Z <i>sur demande</i>		6003 ZZ 11.90		6003 2RS 13.10		---	
<b>20</b>	42	12	6004 Z <i>sur demande</i>		6004 ZZ 12.90		6004 2RS 14.40		---	
<b>25</b>	47	12	6005 Z <i>sur demande</i>		6005 ZZ 14.70		6005 2RS 16.50	6005 INOX 27.10		
<b>30</b>	55	13	---		---		6006 2RS 30.90		---	
<b>35</b>	62	14	---		---		6007 2RS 37.70		---	
<b>40</b>	68	15	---		---		6008 2RS 58.90		---	

mm	mm	mm	Art. N :	CHF sans TVA	Art. N :	CHF sans TVA	Art. N :	CHF sans TVA	Art. N :	CHF sans TVA
<b>SERIE: 6200</b>										
<b>Z</b>										
<b>ZZ</b>										
<b>2RS</b>										
<b>INOX</b>										
<b>10</b>	30	9	6200 Z <i>sur demande</i>		6200 ZZ 9.70		6200 2RS 9.70		---	
<b>12</b>	32	10	6201 Z <i>sur demande</i>		6201 ZZ 10.10		6201 2RS 10.10		6201 INOX 14.40	
<b>15</b>	35	11	6202 Z <i>sur demande</i>		6202 ZZ 11.00		6202 2RS 11.00		---	
<b>17</b>	40	12	6203 Z <i>sur demande</i>		6203 ZZ 12.10		6203 2RS 12.10		6203 INOX 19.70	
<b>20</b>	47	14	6204 Z <i>sur demande</i>		6204 ZZ 13.90		6204 2RS 13.90		6204 INOX 22.00	
<b>25</b>	52	15	6205 Z <i>sur demande</i>		6205 ZZ 14.30		6205 2RS 16.00		---	
<b>30</b>	62	16	6206 Z <i>sur demande</i>		6206 ZZ 22.20		6206 2RS 24.80		---	
<b>35</b>	72	17	6207 Z <i>sur demande</i>		6207 ZZ 29.30		6207 2RS 32.70		---	
<b>40</b>	80	18	---		---		6208 2RS 62.60		---	
<b>SERIE: 6300</b>										
<b>Z</b>										
<b>ZZ</b>										
<b>2RS</b>										
<b>INOX</b>										
<b>10</b>	35	11	6300 Z <i>sur demande</i>		6300 ZZ 12.70		6300 2RS 13.90		---	
<b>12</b>	37	12	6301 Z <i>sur demande</i>		6301 ZZ 11.20		6301 2RS 12.90		6301 INOX 14.80	
<b>15</b>	42	13	6302 Z <i>sur demande</i>		6302 ZZ 13.90		6302 2RS 15.50		---	
<b>17</b>	47	14	6303 Z <i>sur demande</i>		6303 ZZ 15.50		6303 2RS 17.50		---	
<b>20</b>	52	15	6304 Z <i>sur demande</i>		6304 ZZ 18.00		6304 2RS 20.40		---	
<b>25</b>	62	17	6305 Z <i>sur demande</i>		6305 ZZ 20.20		6305 2RS 23.20		6305 INOX 26.70	
<b>30</b>	72	19	6306 Z <i>sur demande</i>		6306 ZZ 31.10		6306 2RS 35.10		---	
<b>35</b>	80	21	6307 Z <i>sur demande</i>		6307 ZZ 42.60		6307 2RS 47.70		---	
<b>40</b>	90	23	6308 Z <i>sur demande</i>		6308 ZZ 59.20		6308 2RS 66.40		---	

AUTRES GRANDEURS DISPONIBLES / ANDERE VERFÜGBAREN GRÖßEN / ALTRE DIMENSIONI DISPONIBILI

**ROUES-ACCESSOIRES-SYSTÈMES DE FIXATIONS**

**RÄDER-ZUBEHÖR-BEFESTIGUNGSSYSTEM**

**RUOTE-ACCESSORI-SISTEMI DI FISSAZIONI**

ROUE À PALIER LISSE, ROULEMENT À ROULEAUX OU À BILLES

RAD MIT GLEITLAGER, ROLLENLAGER ODER KUGELLAGER

RUOTA A FORO LISCIO, SU CUSCINETTO A RULLI E A SFERE

**ENTRETOISES / TUBES**

Entretoises et tubes de distance/réduction, en acier zingué  
Boulons et écrous autobloquants

**DISTANZ-RÖHRCHEN**

Distanz-Röhrchen, aus Stahl verzinkt  
Schrauben und Stop-Muttern

**TUBETTO ASSALE**

Tubetto assale, in acciaio zincato  
Vite testa esagonale e dado triblock

mm	mm	mm	mm	Art. N :		Art. N :		Art. N :		Art. N :	
				Art. N :	CHF sans TVA	Art. N :	CHF sans TVA	INOX	CHF sans TVA	INOX	CHF sans TVA
50 - 75	A)	8 / 6	M 6	DR 06	1.30	SM 06	1.10	X-DR 06	2.80	X-SM 06	2.80
80 - 125	A)	12 / 8	M 8	DR 08	1.80	SM 08	1.70	X-DR 08	3.60	X-SM 08	3.40
125 - 150	A)	15 / 10	M 10	DR 10	2.60	SM 10	2.40	X-DR 10	5.20	X-SM 10	4.60
125 - 200	A)	20 / 12	M 12	DR 12	3.10	SM 12	2.80	X-DR 12	7.50	X-SM 12	6.90
250 - 400	A)	25 / 17	M 16	DR 16	9.20	SM 16	8.80	X-DR 16	17.90	X-SM 16	13.70
250 - 400	A)	25 / 20	M 20	DR 20	11.00	---	---	---	---	---	---

A) IL EST RECOMMANDÉ DE NOUS DONNER LE N° D'ARTICLE DE LA ROUE / ES IST ZU EMPFEHLEN, DIE RAD-ARTIKEL N° ANZUGEBEN / SI RACCOMANDA DI DARCI IL IL N° D'ARTICOLO DELLA RUOTA

EGALEMENT RONDELLE DE DISTANCE/REDUCTION: Ø 8/10mm\_DS 08 / Ø 10/12mm\_DS10 =CHF 0.80, INOX =CHF 1.10  
AUCH DISTANZ-SCHEIBEN/REDUKTION: Ø 8/10mm\_DS 08 / Ø 10/12mm\_DS10 =CHF 0.80, INOX =CHF 1.10  
ANCHE DISTANZIALE/RIDUTTORE LATERALE: Ø 8/10mm\_DS 08 / Ø 10/12mm\_DS10 =CHF 0.80, INOX =CHF 1.10

**PROTÈGE-PAROIS / BUTOIRS**

Protège-parois ou butoirs, en Polyuréthan 60 Sh/A, gris

**ABWEISER**

Abweiser, aus Polyurethan 60 Sh/A, grau

**PARACOLPI**

Paracolpi, in Poliuretano, 60 Sh/A, grigia

No. BR...

mm			Art. N :		CHF sans TVA
ROND / RUND / TONDO					
90	20	19	BR 19	4.60	
90	20	22	BR 22	4.60	
90	20	25.5	BR 25	4.60	
90	20	28	BR 28	4.60	
90	20	30.5	BR 30	4.60	
90	20	32	BR 32	4.60	

No. BC...

mm			Art. N :		CHF sans TVA
CARRÉ / VIERKANT / QUADRO					
90	20	20x20	BC 20	4.60	
90	20	25x25	BC 25	4.60	
90	20	30x30	BC 30	8.50	
90	20	35x35	BC 35	8.50	
90	20	40x40	BC 40	8.50	

**RONDELLE DE BLOCAGE**

Rondelle de blocage pour fixation des roues sur les axes en acier zingué

**STELLRINGE**

Stellringe zum Befestigen der Räder auf Wellen aus Stahl verzinkt

**DISCO DI BLOCCO**

Disco per fissazione delle ruote sugli assi in acciaio zincato

mm	Art. N :	CHF sans TVA	mm	Art. N :	CHF sans TVA	mm	Art. N :	CHF sans TVA	mm	Art. N :	CHF sans TVA
20	Blocage 20mm	7.80	25	Blocage 25mm	9.00	30	Blocage 30mm	13.40	35	Blocage 35mm	16.80

**RABAIS / RABATT / SCONTO : 20%**

dès/ab/da 100.-- (CHF)

**25%** dès/ab/da 500.-- (CHF)

RABAIS DE QUANTITE SUR DEMANDE !

MENGENRABATT AUF ANFRAGE !

SCONTO DI QUANTITA SU RICHIESTA !

**DOUILLES POLYAMIDE**

Douille de fixation en Polyamide, pour tubes ronds ou carrés, convenant pour tige 10mm

**POLYAMID-HUELSEN**

Einsteckhülsen aus Polyamid, für Rund- oder Vierkantrohre, passend für Bolzen 10mm

**POLIAMMIDE ADATTATORE**

Adattatore di attacco in Poliammide per tubetto tondo o quadrato, per attacco filetto 10mm

No. FR...



			ROND / RUND / TONDO	
mm	mm	mm	Art. N :	CHF sans TVA
<b>ROND / RUND / TONDO</b>				
13	10.1	10x30	FR 13	2.20
14	10.1	10x30	FR 14	2.20
15	10.1	10x30	FR 15	2.20
17	10.1	10x30	FR 17	2.20
19	10.1	10x30	FR 19	2.20
22	10.1	10x30	FR 22	2.20
23	10.1	10x30	FR 23	2.20
26	10.1	10x30	FR 26	2.20

No. FC...



			CARRÉ / VIERKANT / QUADRO	
mm	mm	mm	Art. N :	CHF sans TVA
<b>CARRÉ / VIERKANT / QUADRO</b>				
16x16	10.1	10x30	FC 16	2.50
17x17	10.1	10x30	FC 17	2.50
18x18	10.1	10x30	FC 18	2.50
21x21	10.1	10x30	FC 21	2.50
22x22	10.1	10x30	FC 22	2.50
23x23	10.1	10x30	FC 23	2.50

**FIXATIONS**

Douille de fixation extensible en Polyamide, avec filet rapporté en alu + vis M10, pour tubes ronds ou carrés,

**BEFESTIGUNGEN**

Kunststoffsprezhülsen, mit Alu-Gewindeinsatz + Schraube M10, für Rund- oder Vierkantrohre,

**SISTEMI DI ATTACO**

Adattatore espansore in Poliammide con filetto Aluminium + vite M10, per tubetto tondo o quadrato

No. S07...



mm	mm	mm	Art. N :	CHF sans TVA	Art. N :	CHF sans TVA
<b>ROND / RUND / TONDO</b>						
14 - 15	45	M10x55	T01 14-15	6.90	---	---
15 - 16	45	M10x55	T01 15-16	6.90	---	---
16 - 17	45	M10x55	T01 16-17	6.90	---	---
18 - 20	45	M10x55	S07 18-20	6.90	X-S07 18-20	9.50
21 - 23	45	M10x55	S07 21-23	6.90	X-S07 21-23	9.50
24 - 27	45	M10x55	S07 24-27	6.90	X-S07 24-27	9.50
28 - 31	70	M10x80	S07 28-31	10.50	X-S07 28-31	13.10
31 - 35	70	M10x80	S07 31-35	10.50	X-S07 31-35	13.10

No. S47...



mm	mm	mm	Art. N :	CHF sans TVA	Art. N :	CHF sans TVA
<b>CARRÉ / VIERKANT / QUADRO</b>						
18x18 - 20x20	45	M10x55	S47 18-20	6.90	X-S47 18-20	9.50
21x21 - 23x23	45	M10x55	S47 21-23	6.90	X-S47 21-23	9.50
24x24 - 27x27	45	M10x55	S47 24-27	6.90	X-S47 24-27	9.50
28x28 - 31x31	45	M10x55	S47 28-31	6.90	X-S47 28-31	9.50
31x31 - 35x35	70	M10x80	S47 31-35	10.50	X-S47 31-35	13.10
36x36 - 40x40	70	M10x80	S47 36-40	10.50	X-S47 36-40	13.10

**VIS****SCHRAUBE****VITE****PIVOT**

Pivot en acier, aussi avec trou fileté, pour tubes ronds

**ZAPFEN**

Stahleinsteckzapfen, auch mit Gewindebohrung, für Rundrohre

**ATTACCO**

Attacco in acciaio, anche con filetto, per tubetto tondo

No. S78-72



mm	mm	mm	Art. N :	CHF sans TVA	Art. N :	CHF sans TVA
<b>INOX</b>						
M8	15 - 30		S 78>30	1.50	---	---
M10	15 - 30		S 71>30	1.50	X-S 71>30	3.40
M10	40 - 60		S 71>60	1.70	X-S 71>60	3.60
M12	15 - 30		S 72>30	1.70	X-S 72>30	3.60
M12	40 - 60		S 72>60	1.90	X-S 72>60	4.00

No. RC...



mm	mm	mm	Art. N :	CHF sans TVA	mm	mm	Art. N :	CHF sans TVA
20	45		RC20	14.00	M8	20	RC20-M8	19.00
22	45		RC22	14.00	M8	20	RC22-M8	19.00

AUTRES GRANDEURS DISPONIBLES / ANDERE VERFÜGBAREN GRÖßEN / ALTRE DIMENSIONI DISPONIBILI





ROUE À PALIER LISSE, ROULEMENT À ROULEAUX OU À BILLES

RAD MIT GLEITLAGER, ROLLENLAGER ODER KUGELLAGER

RUOTA A FORO LISCIO, SU CUSCINETTO A RULLI E A SFERE

**ROULETTE-PIED, À PÉDALE**

Roulette de levage pivotante à plaque + pied à pédale  
Roue Polyuréthane, roue a palier lisse ou avec roulement à billes, non-tachant, silencieux, corps/roue: Fonte

**FUSS-ROLLEN, MIT PEDAL**

Plattenlenkrolle + Pedalfuss,  
Polyurethanrad, Rad mit Gleitlager oder Kugellager  
spurfrei, Laufruhe, Radkörper: Guss

**PIEDE REGOLABILE CON PEDALE**

Ruota di sollevamento girevole con piastra + pedale  
Ruota in Poliuretano, ruota a foro liscio o su cuscinetti a sfere  
antitraccia, silenzia, corpo centrale: Ghisa

mm	mm	Page 1.6	kg	mm	mm	mm	mm	mm	mm	Cours Hub Corsa	Art. N :	CHF sans TVA	MOUVEMENT FAHREN / GO	FIXE STAND / STOP	
<b>ZINGUE_SERIE 'MEDIA - FORT'</b>															
80	25		150	105x85	80x60	9	117>123	A) 6			5191.08-pied	143.00			
75	40		300	105x85	80x60	9	115>123	A) 8			5193.07-pied	197.00			
125	50		450	135x110	105x80	13	171>181	A) 10			6193.12-pied	268.00			

A) COURSE VERTICALE DU PIED / VERTIKALE HUBWEG DES FUSS / CORSA VERTICALE DEL PIEDE

AUTRES MODÈLES ET GRANDEURS DISPONIBLES / ANDERE MODELLE UND GRÖSSEN VERFÜGBAR / ALTRI MODELLI E DIMENSIONI DISPONIBILI

**BÉQUILLE POUR REMORQUE**

Roue Caoutchouc Plein, noir, roue a palier lisse ou avec roulement à rouleaux, silencieux, corps/roue: Acier

**STÜTZRAD FÜR ANHÄNGER**

Vollgummirad, schwarz, Rad mit Gleitlager oder Rollenlager, Laufruhe, Radkörper: Stahl

**STAMPELL PER RIMORCHIO**

Ruota in Gomma, nera, ruota a foro liscio o su cuscinetti a sfere, silenzia, corpo centrale: Acciaio

mm	mm	Page 1.6	kg	mm	mm	mm	mm	mm	mm	Tube Rohr Tubo	Cours Hub Corsa	Art. N :	CHF sans TVA	Art. N :	CHF sans TVA	Art. N :	CHF sans TVA	Art. N :	CHF sans TVA				
<b>ZINGUE_SERIE 'LEGER - MEDIA - FORT'</b>																							
200	40		150	131x55	105	Ø 48	630	A) 220				Béquille.150	53.00	--	--			Fix-béq.150	17.00	55	20	42.20-béq.150	18.00
200	60		250	130x105	105x75 70x50	Ø 60	640	A) 300				--		Béquille.250	109.00	--	--	--		60	20	42.20-béq.250	20.00
230	80		500	130x100	105x50 70x50	Ø 60	750	A) 340				--		--		Béquille.500	149.00	--		100	20	42.20-béq.500	79.00

A) COURSE VERTICALE DU RESSORT / VERTIKALE HUBWEG DES FEDER / CORSA VERTICALE DELLA MOLLA

AUTRES MODÈLES ET GRANDEURS DISPONIBLES / ANDERE MODELLE UND GRÖSSEN VERFÜGBAR / ALTRI MODELLI E DIMENSIONI DISPONIBILI

**COURONNE DE PIVOT SUR PLAQUE**

Pivotement sur simple rangée de billes ou double chemin de billes dans la couronne du pivot, Acier zingué

**DREHKRÄNZE AUF PLATTE**

Schwenklager mit einfachem kugelkranz oder Zweifache Kugellagerung im Drehkranz, Stahl-verzinkt

**GRUPPI ROTANTI A PIASTRA**

Piroettamento a una corona di sfere o doppio cuscinetto a sfere nel gruppo rotante, Acciaio zincato

kg	mm	Page 1.6	kg	mm	mm	mm	mm	mm	mm	Art. N :	CHF sans TVA	Art. N :	CHF sans TVA	Art. N :	CHF sans TVA	Art. N :	CHF sans TVA	Art. N :	CHF sans TVA
<b>ZINGUE_SERIE 'LEGER - MEDIA - FORT'</b>																			
A)	50	--	--	57x57 _1mm	43x43	6.5	11	--	0,100	Pivot.050	24.00	--	--	--	--	--	--	--	--
A)	280	--	--	95x70 _3mm	75x45	6.5	20	--	0,400	--		Pivot.280	33.00	--	--	--	--	--	--
B)	400	--	--	140x110 _4mm	105x 75-80	11	28	--	1,100	--		--		Pivot..400	72.00	--	--	--	--
C)	1000	--	--	140x110 _5mm	105x 75-80	11	31	--	1,300	--		--		--		Pivot.1000	145.00	--	--
D)	1500	--	--	140x110 _8mm	105x 75-80	11	37	--	2,600	--		--		--		--		Pivot..1500	199.00

A) PIVOTEMENT SUR SIMPLE RANGÉE DE BILLES / SCHWENKLAGER MIT EINFACHEM KUGELKRANZ / PIROETTAMENTO A UNA CORONA DI SFERE

B) DOUBLE CHEMIN DE BILLES DANS LA COURONNE DU PIVOT / ZWEIFACHE KUGELLAGERUNG IM DREHKRANZ / DOPPIO CUSCINETTO A SFERE NEL GRUPPO ROTANTE

C) CHEMIN DE BILLES A QUATRE POINTS POUR LES CHARGES LES PLUS FORTES / VIER-PUNKT-KUGELLAGERUNG FÜR HÖCHSTE LASTEN / CUSCINETTO A SFERE A QUATTRO PUNTI PER CARICHI ECCEZIONALI

+COURONNE DU PIVOT FERME, ETANCHE / GESCHLOSSENER, ABGEDICHTETER DREHKRANZ / GRUPPO ROTANTE CHIUSO ED A TENUTA

D) BUTÉE A BILLES ISO 104 ET ROULEMENT A ROULEAUX CONIQUES ISO 355 / AXIAL-RILLENKUGELLAGER ISO 104 UND KEGELROLLENLAGER ISO 355 / AXIAL-RILLENKUGELLAGER ISO 104 UND KEGELROLLENLAGER ISO 355

+ETANCHE AUX PROJECTIONS D'EAU ET A LA POUSSIERE / STAUB- UND SPRITZWASSERGESCHÜTZT / PROTETTO CONTRO SPRUZZI D'ACQUA E SPORCO



# POULIES, GALETS DE PORTE

## SEILROLLEN, TÜRROLLEN

### PULEGGE, RULLI DI PORTE

# 8

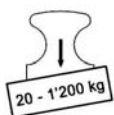

20 – 1'200 kg



20 - 350 mm

INDEX / INHALT / INDICE



**PAGE 8.1**  
POULIE CABLE  
DRAHTSEILROLLE  
PULEGGE CAVI



**PAGE 8.2**  
POULIE CABLE  
DRAHTSEILROLLE  
PULEGGE CAVI



**PAGE 8.2**  
POULIE A GORGE  
SEILROLLEN  
PULEGGE CANALE



**PAGE 8.2**  
POULIE A GORGE  
SEILROLLEN  
PULEGGE CANALE



**PAGE 8.3**  
GALET PORTE  
SCHIEBTORROLLE  
RULLI DI PORTE



**PAGE 8.3**  
GALET PORTE  
SCHIEBTORROLLE  
RULLI DI PORTE



**PAGE 8.4**  
GALET PORTE  
SCHIEBTORROLLE  
RULLI DI PORTE



**PAGE 8.4**  
GALET PORTE  
SCHIEBTORROLLE  
RULLI DI PORTE



**PAGE 8.5**  
GALET PORTE  
SCHIEBTORROLLE  
RULLI DI PORTE



**PAGE 8.5**  
ROUE WAGON  
SPURKRANZRAD  
RUOTA BORDINO

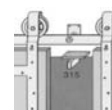

**PAGE 8.6**  
FERRURE PORTE  
SCHIEBTORBESCH  
MONTAGGI PORTE



**PAGE 8.7-8**  
POULIE A GORGE  
SEILROLLEN  
PULEGGE CANALE



**PAGE 8.7-8**  
SPECIALITE  
SPEZIALITAT  
SPECIALITA



**PAGE 8.7-8**  
GALET  
SCHIEBTOR  
RULLI



**PAGE 8.8**  
CHARIOT  
WAGEN  
CARROLO



**PAGE 8.8**  
BANDAGE  
VERBAND  
BENDAGGIO

SECTEURS / BEREICHE / SETTORI





**IMPORTANT POUR TOUTES LES POULIES / WICHTIG FÜR ALLE SEILROLLEN / IMPORTANDO PER TUTTE LE PULEGGE**

**Charge / Tragkraft / Portata**

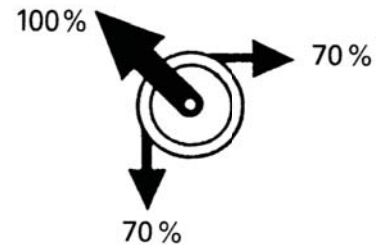
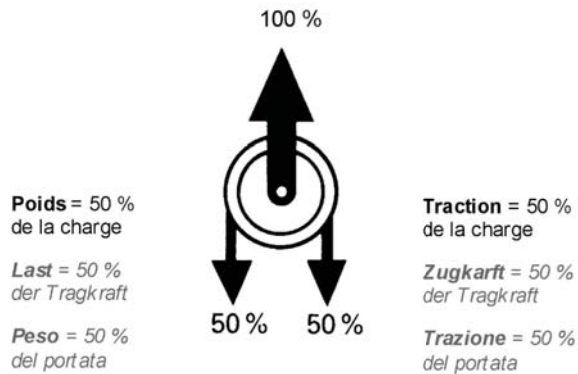

**100 – 1000 kg**

**POULIES POUR CÂBLES**

Poulie pour câble avec gorge en V, gris,  
poulie avec roulement à billes, angle de flanc 40°  
corps/roue: Acier ou Fonte galvanisés

**DRAHTSEILROLLEN**

Drahtseilrollen mit V-Rille, grau,  
Drahtseilrollen mit Kugellager, Flankenwinkel 40°  
Radkörper: Stahl oder Guss verzinkt

**PULEGGE PER CAVI**

Pulegge a canale in V, grigia  
pulegge su cuscinetto a sfere, angolo di fianco 40°  
corpo centrale: Acciaio o Ghisa zincato

**No. 674**

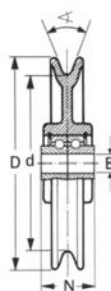

D	d		N	B									
mm	mm	mm	Page 1.6	kg	mm	°	mm	mm	mm				
<b>ACIER / STAHL / ACCIAIO</b>													
<b>50</b>	37	16		<b>100</b>	2.5	40°	19	6.2	M6x35	<b>674 / 050</b>		44.90	
<b>60</b>	46	16		<b>100</b>	3	40°	19	6.2	M6x35	<b>674 / 060</b>		49.80	
<b>FONTE / GUSS / GHISA</b>													
<b>80</b>	65	23		<b>200</b>	4	40°	26	8.2	M8x45	<b>674 / 080</b>		75.80	
<b>100</b>	83	27		<b>300</b>	4	40°	30	10.2	M10x55	<b>674 / 100</b>		82.40	
<b>120</b>	100	27		<b>400</b>	5	40°	30	12.2	M12x60	<b>674 / 120</b>		100.10	
<b>150</b>	130	24		<b>500</b>	6.5	40°	34	14.2	M14x65	<b>674 / 150</b>		120.20	
<b>180</b>	160	24		<b>500</b>	8	40°	34	14.2	M14x65	<b>674 / 180</b>		149.20	
<b>210</b>	185	35		<b>800</b>	9	40°	38	16.5	M16x70	<b>674 / 210</b>		235.80	
<b>240</b>	206	35		<b>800</b>	10	30°	38	16.5	M16x70	<b>674 / 240</b>		264.20	
<b>300</b>	265	35		<b>1000</b>	12	30°	38	16.5	M16x70	<b>674 / 300</b>		354.70	

**POULIES POUR CÂBLES - GALETS DE PORTES**

AVEC GORGE RONDE, GORGE CARRÉ OU GORGE EN V  
AVEC PALIER LISSE, ROULEMENT À ROULEAUX OU À BILLES

**DRAHTSEILROLLEN - SCHIEBETORROLLEN**

MIT RUNDER RILLE, KANTIGER RILLE ODER V-RILLE  
MIT GLEITLAGER, ROLLENLAGER ODER KUGELLAGER

**PULEGGE PER CAVI - RULLI DI PORTE**

A CANALE TONDO, A CANALE QUADRO O A CANALE IN V  
A FORO LISCIO, SU CUSCINETTO A RULLI E A SFERE

**60 – 150 kg****POULIES POUR CÂBLES**

Poulie pour câble avec gorge en V, noir,  
poulie avec roulement à billes,  
corps/roue: Polyamide (Ultramid)

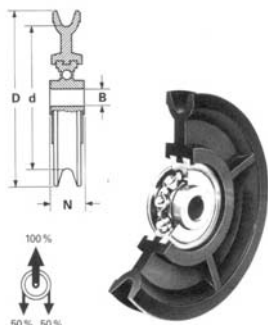
**No. 604****DRAHTSEILROLLEN**

Drahtseilrollen mit V-Rille, schwarz,  
Drahtseilrollen mit Kugellager,  
Radkörper: Polyamid (Ultramid)

**PULEGGE PER CAVI**

Pulegge a canale in V, nera  
pulegge su cuscinetto a sfere  
corpo centrale: Poliammide (Ultramid)

D	d		N	B										
mm	mm	mm	Page 1.6	kg	mm	°	mm	mm	mm					
50	38	11		60	3	40°	14	6.2	---	604 / 050	32.80			
60	46	13		70	4	40°	16	6.2	---	604 / 060	35.10			
80	64	13		100	5	40°	16	8.2	---	604 / 080	39.00			
100	85	15		150	5	40°	18	10.2	---	604 / 100	47.50			

**20 – 140 kg****POULIES À GORGE**

Poulie à gorge ronde, blanc, poulie à palier lisse,  
corps/roue: Polyamide

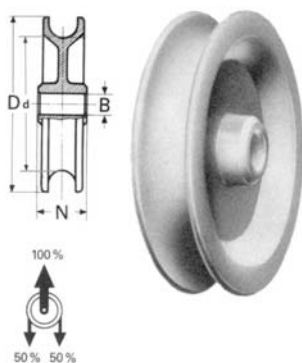
**No. 690****SEILROLLEN**

Seilrollen mit runder Rille, weiss, Drahtseilrollen mit Gleitlager,  
Radkörper: Polyamid

**PULEGGE A CANALE**

Pulegge a canale tondo, bianco, pulegge a foro liscio  
corpo centrale: Poliammide

D	d		N	B										
mm	mm	mm	Page 1.6	kg	mm	mm	mm	mm	mm					
20	11	6		20	4	---	8	5.2	---	690 / 020	3.60			
30	22	9		20	5	---	11	5.2	---	690 / 030	4.70			
40	28	11		30	8	---	13	6.2	---	690 / 040	4.90			
50	38	13		40	8	---	15	6.2	---	690 / 050	6.20			
60	44	16		60	10	---	18	8.2	---	690 / 060	8.70			
80	59	21		90	12	---	23	10.2	---	690 / 080	16.40			
100	74	26		120	16	---	28	12.2	---	690 / 100	24.80			
120	94	26		140	16	---	28	14.2	---	690 / 120	39.00			

**POULIES À GORGE**

Poulie à gorge ronde, gris, poulie à palier lisse  
corps/roue: Acier ou Fonte galvanisés

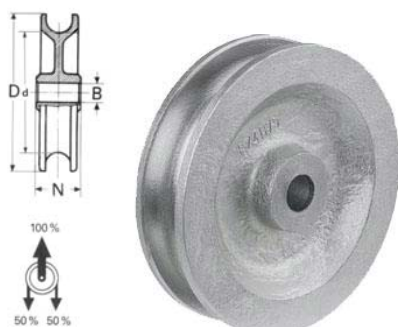
**No. 691****SEILROLLEN**

Seilrollen mit runder Rille, grau, Drahtseilrollen mit Gleitlager,  
Radkörper: Stahl oder Guss verzinkt

**PULEGGE A CANALE**

Pulegge a canale tondo, grigia, pulegge a foro liscio,  
corpo centrale: Acciaio o Ghisa zincato

D	d		N	B											
mm	mm	mm	Page 1.6	kg	mm	mm	mm	mm	mm						
<b>ACIER / STAHL / ACCIAIO</b>															
30	22	11		20	5	---	11	5.2	---	691 / 030	12.50				
40	28	13		30	7	---	13	6.2	---	691 / 040	15.50				
50	38	15		40	8	---	15	6.2	---	691 / 050	19.50				
60	44	18		60	10	---	18	8.2	---	691 / 060	28.90				
<b>FONTE / GUSS / GHISA</b>															
80	58	23		90	12	---	23	10.2	---	691 / 080	40.00				
100	76	28		120	16	---	28	12.2	---	691 / 100	50.30				

**RABAIS / RABATT / SCONTO :**

RABAIS DE QUANTITE SUR DEMANDE !

**20%** dès/ab/da **100.--** (CHF)

MENGENRABATT AUF ANFRAGE !

**25%** dès/ab/da **500.--** (CHF)

SCONTO DI QUANTITA SU RICHIESTA !

**POULIES POUR CÂBLES - GALETS DE PORTES**

AVEC GORGE RONDE, GORGE CARRÉ OU GORGE EN V  
AVEC PALIER LISSE, ROULEMENT À ROULEAUX OU À BILLES

**DRAHTSEILROLLEN - SCHIEBTORROLLEN**

MIT RUNDER RILLE, KANTIGER RILLE ODER V-RILLE  
MIT GLEITLAGER, ROLLENLAGER ODER KUGELLAGER

**PULEGGE PER CAVI - RULLI DI PORTE**

A CANALE TONDO, A CANALE QUADRO O A CANALE IN V  
A FORO LISCIO, SU CUSCINETTO A RULLI E A SFERE

**80 – 500 kg****GALETS DE PORTES**

Galets pour portes coulissantes à gorge carré, gris,  
galet avec roulement à billes,  
corps/roue: Fonte, galvanisé à chaud

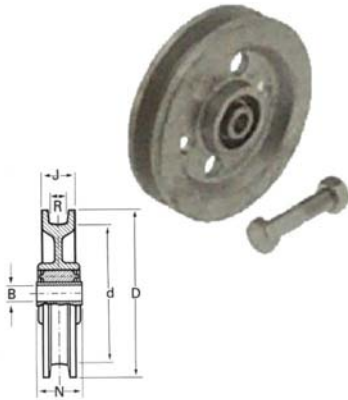
**No. 652 Z****SCHIEBTORROLLEN**

Schiebtorrolle mit kantiger Rille, grau,  
Schiebtorrolle mit Kugellager,  
Radkörper: Guss, feuerverzinkt

**RULLI DI PORTE**

Rulli adatte per cancelli e portoni a canale quadro,  
grigia, rulli su cuscinetto a sfere  
corpo centrale: Ghisa, Galvanizzato a caldo

D	d	J	R	N	B							
mm	mm	mm	Page 1.6	kg	mm	mm°	mm	mm	mm	mm	Art. N :	Prix Preis Prezzo CHF sans TVA
50	36	15		80	---	6	19	6.2	M6x35	652 Z / 050	56.20	
60	46	16		100	---	7	19	6.2	M6x35	652 Z / 060	59.00	
70	54	18		120	---	7	26	8.2	M8x45	652 Z / 070	71.10	
80	62	19		150	---	8	26	8.2	M8x45	652 Z / 080	82.10	
100	80	24		250	---	11	30	10.2	M10x55	652 Z / 100	104.20	
120	98	26		300	---	12	30	12.2	M12x60	652 Z / 120	134.50	
150	126	29		400	---	13	34	14.2	M14x65	652 Z / 150	165.80	
180	156	29		500	---	13	34	14.2	M14x65	652 Z / 180	226.50	

**700 – 1000 kg****GALETS DE PORTES**

Galets pour portes coulissantes à gorge ronde, gris,  
galet avec roulement à billes,  
corps/roue: Fonte, galvanisé à chaud

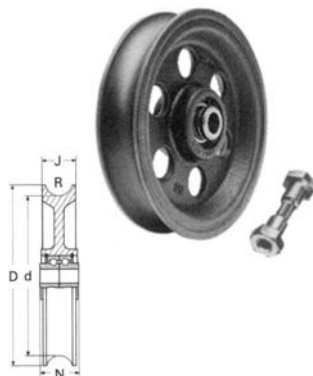
**No. 656 Z****SCHIEBTORROLLEN**

Schiebetor mit runder Rille, grau,  
Schiebtorrolle mit Kugellager,  
Radkörper: Guss, feuerverzinkt

**RULLI DI PORTE**

Rulli adatte per cancelli e portoni a canale tondo,  
grigia, rulli su cuscinetto a sfere  
corpo centrale: Ghisa, Galvanizzato a caldo

D	d	J	R	N	B							
mm	mm	mm	Page 1.6	kg	mm	mm°	mm	mm	mm	mm	Art. N :	Prix Preis Prezzo CHF sans TVA
120	98	34		700	---	27 (¾")	38	14.2	M14x55	656 Z / 120	140.00	
150	128	34		800	---	27 (¾")	38	14.2	M14x55	656 Z / 150	168.60	
180	158	34		900	---	27 (¾")	38	14.2	M14x55	656 Z / 180	200.80	
250	224	48		1000	---	34 (1")	54	20.3	M20x85	656 Z / 250	471.10	





**POULIES POUR CÂBLES - GALETS DE PORTES**

AVEC GORGE RONDE, GORGE CARRÉ OU GORGE EN V  
AVEC PALIER LISSE, ROULEMENT À ROULEAUX OU À BILLES

**DRAHTSEILROLLEN - SCHIEBETORROLLEN**

MIT RUNDER RILLE, KANTIGER RILLE ODER V-RILLE  
MIT GLEITLAGER, ROLLENLAGER ODER KUGELLAGER

**PULEGGE PER CAVI - RULLI DI PORTE**

A CANALE TONDO, A CANALE QUADRO O A CANALE IN V  
A FORO LISCIO, SU CUSCINETTO A RULLI E A SFERE

**800 – 1200 kg****GALETS DE PORTES**

Galets pour portes coulissantes à gorge carré, gris,  
galet avec roulement à billes,  
corps/roue: Acier de traitement Ck 15, galvanisé

**SCHIEBTORROLLEN**

Schiebetor mit kantiger Rille, grau,  
Schiebetorrolle mit Kugellager,  
Radkörper: Vergütungsstahl Ck 15, galvanized

**RULLI DI PORTE**

Rulli adatte per cancelli e portoni a canale quadro,  
grigia, rulli su cuscinetto a sfere, corpo centrale:  
Acciaio di trattamento Ck 15, galvanizzato

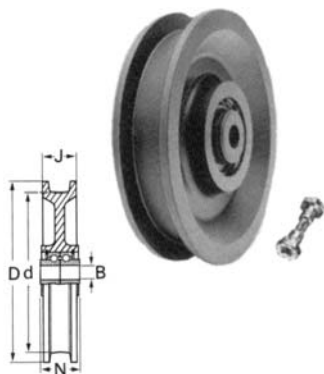
**No. 654 K**

D	d	J		N	B						Art. N :	Prix Preis Prezzo
mm	mm	mm	Page 1.6	kg	mm	mm°	mm	mm	mm	mm	CHF sans TVA	
120	100	34		800	---	17	38	14.2	M14x65	654 K / 120	165.20	
150	128	34		1000	---	22	38	14.2	M14x65	654 K / 150	206.90	
177	158	34		1200	---	22	38	14.2	M14x65	654 K / 177	335.30	

**800 – 1200 kg****GALETS DE PORTES**

Galets pour portes coulissantes à gorge ronde, gris,  
galet avec roulement à billes,  
corps/roue: Acier de traitement Ck 15, galvanisé

**SCHIEBTORROLLEN**

Schiebetor mit runder Rille, grau,  
Schiebetorrolle mit Kugellager,  
Radkörper: Vergütungsstahl Ck 15, galvanized

**RULLI DI PORTE**

Rulli adatte per cancelli e portoni a canale tondo,  
grigia, rulli su cuscinetto a sfere, corpo centrale:  
Acciaio di trattamento Ck 15, galvanizzato

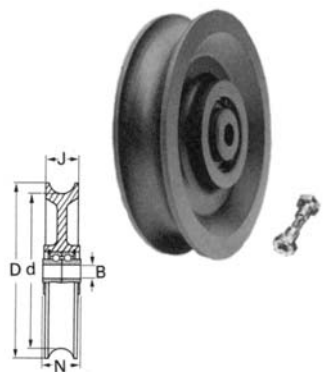
**No. 654 R**

D	d	J		N	B						Art. N :	Prix Preis Prezzo
mm	mm	mm	Page 1.6	kg	mm	mm°	mm	mm	mm	mm	CHF sans TVA	
120	98	34		800	---	27 (¾)	38	14.2	M14x65	654 R / 120	165.20	
150	128	34		1000	---	27 (¾)	38	14.2	M14x65	654 R / 150	206.90	
177	158	34		1200	---	27 (¾)	38	14.2	M14x65	654 R / 177	335.30	

**AUTRES GRANDEURS DISPONIBLES, EGALEMENT EN NYLON 6**  
**ANDERE VERFÜGBAREN GRÖßEN, AUCH AUS NYLON 6 / ALTRE DIMENSIONI DISPONIBILI, ANCHE IN NYLON 6**

**RABAIS / RABATT / SCONTO : 20% dès/ab/da 100.-- (CHF) / 25% dès/ab/da 500.-- (CHF)**  
RABAIS DE QUANTITE SUR DEMANDE ! MINGENRABATT AUF ANFRAGE ! SCONTO DI QUANTITA SU RICHIESTA !

**POULIES POUR CÂBLES - GALETS DE PORTES**

AVEC GORGE RONDE, GORGE CARRÉ OU GORGE EN V  
AVEC PALIER LISSE, ROULEMENT À ROULEAUX OU À BILLES

**DRAHTSEILROLLEN - SCHIEBETORROLLEN**

MIT RUNDER RILLE, KANTIGER RILLE ODER V-RILLE  
MIT GLEITLAGER, ROLLENLAGER ODER KUGELLAGER

**PULEGGE PER CAVI - RULLI DI PORTE**

A CANALE TONDO, A CANALE QUADRO O A CANALE IN V  
A FORO LISCIO, SU CUSCINETTO A RULLI E A SFERE

**300 – 1200 kg****GALETS DE PORTES**

Galets pour portes coulissantes à gorge V pour profil à équerre, gris, Galet avec roulement à rouleaux et à billes, corps/roue: Fonte, galvanisé à chaud

**SCHIEBETORROLLEN**

Schiebetor mit V-Rille für Winkelprofil, grau, Schiebetorrolle mit Rollenlager und Kugellager, Radkörper: Guss, feuerverzinkt

**RULLI DI PORTE**

Rulli adatte per cancelli e portoni a canale in V per triangolare profilo, grigia, rulli su cuscinetto a rulli e a sfere, corpo centrale: Ghisa, Galvanizzato a caldo

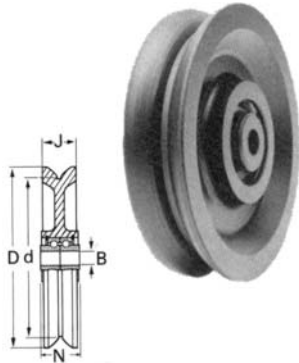
**No. R-54V**

D	d	J	R	N	B	Art. N :	Prix Preis Prezzo
mm	mm	mm	mm	mm	mm		CHF sans TVA
75	50	38	300	60	20	R-54V / 075	47.30
100	80	46	350	60	20	R-54V / 100	72.60
125	100	38	370	60	20	R-54V / 125	94.60
125	100	38	420	57	20	K-54V / 125	116.40
150	123	45	1000	60	25	R-54V / 150	100.20
150	123	45	1050	57	20	K-54V / 150	127.10
200	175	45	1200	60	25	R-54V / 200	153.40

**1000 – 1200 kg****ROUE WAGONNET**

Roue en Fonte pleine, gris, roue avec roulement à rouleaux ou à billes, surface de roulement usinée résistant aux huiles/grasses/essences..., corps/roue: Fonte  
**RECOMMANDÉ POUR ROULER SUR DES RAILS**

**SPURKLANZRÄDER**

Guss-Rad, Vollscheibe, grau, Rad mit Rollenlager oder Kugellager, Lauffläche gedreht  
beständigkeit gegen Öl/Fett/Benzin..., Radkörper: Guss  
**EMPFOHLEN ZUM LAUFEN AUF GLEISE**

**RUOTA CON BORDINO**

Ruota in Ghisa, piena, grigia, ruota su cuscinetti a rulli e a sfere, rotonda superficie fatta resistendo agli oli/grassi/petroli..., corpo centrale: Ghisa  
**RACCOMANDATÒ PER BINARI TIPO FERROVIA**



-20° - +80° C  
70 Sh/A



mm	mm	mm	mm	Page 1.6	kg	mm	mm	Art. N :	Prix Preis Prezzo
									CHF sans TVA
100	125	36	46	1000	52	20	CVG 100	67.80	
100	130	33	46	1000	60	20	CVR 100	99.50	
100	130	33	46	1000	57	20	CVK 100	107.40	
125	145	36	46	1000	52	20	CVG 125	90.30	
150	178	35	45	1200	60	20	CVR 150	104.90	
150	178	35	45	1200	57	20	CVK 150	117.20	



**POULIES POUR CÂBLES - GALETS DE PORTES**

AVEC GORGE RONDE, GORGE CARRÉ OU GORGE EN V  
AVEC PALIER LISSE, ROULEMENT À ROULEAUX OU À BILLES

**DRAHTSEILROLLEN - SCHIEBETORROLLEN**

MIT RUNDER RILLE, KANTIGER RILLE ODER V-RILLE  
MIT GLEITLAGER, ROLLENLAGER ODER KUGELLAGER

**PULEGGE PER CAVI - RULLI DI PORTE**

A CANALE TONDO, A CANALE QUADRO O A CANALE IN V  
A FORO LISCIO, SU CUSCINETTO A RULLI E A SFERE

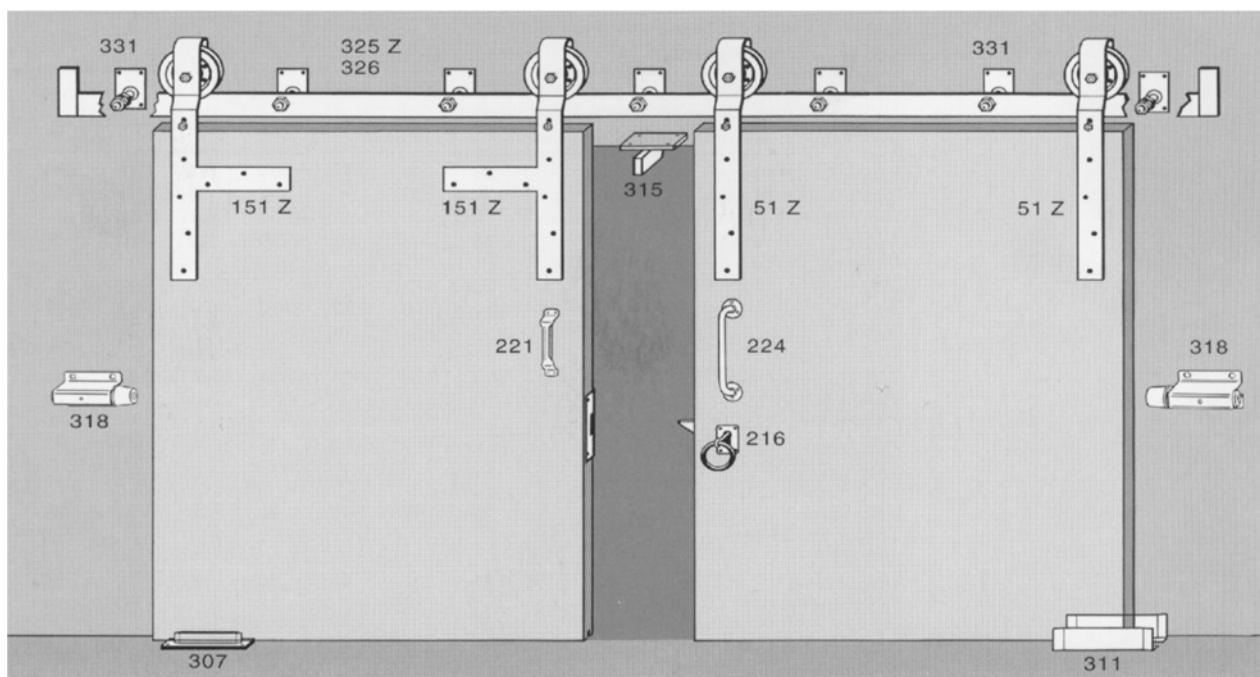
**FERRURES DE PORTES****SCHIEBETORBESCHLÄGE****MONTAGGI DI PORTE****webi**

Exemple de construction pour porte coulissante avec rail supérieur

*Konstruktionsbeispiel für ein obenlaufendes Schiebetor*

*Esempio di costruzione per porte coulissante con barra superiore*

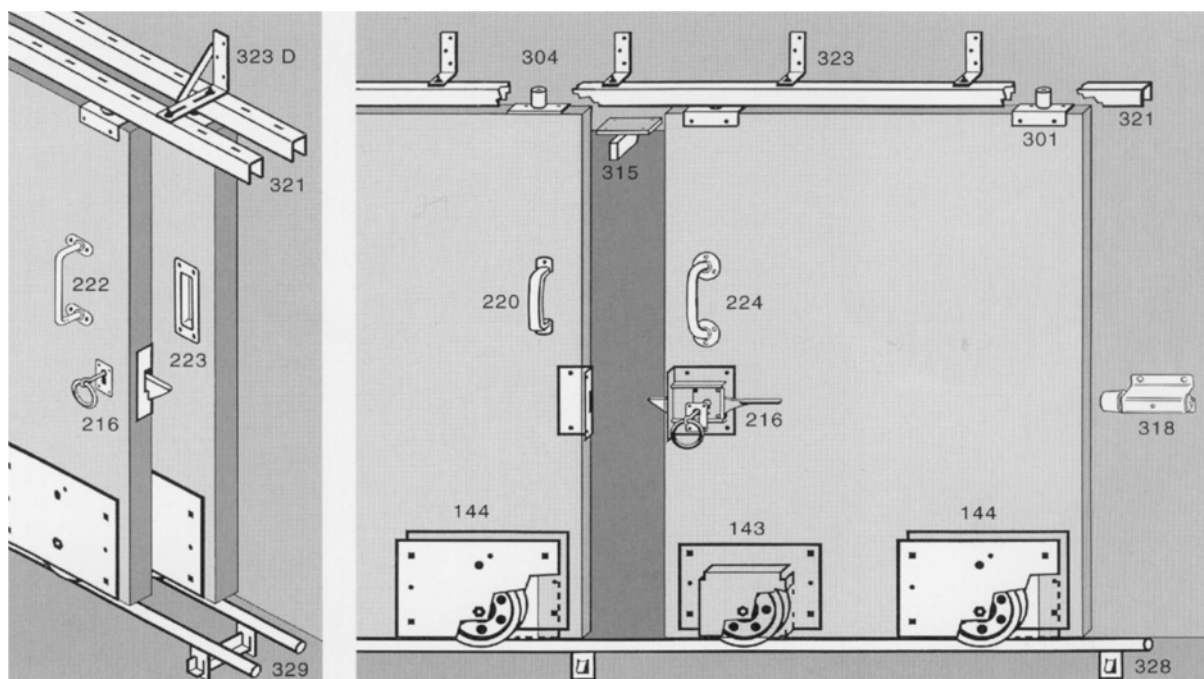

Exemple de construction pour porte coulissante avec rail inférieur

*Konstruktionsbeispiel für ein untenlaufendes Schiebetor*

*Esempio di costruzione per porte coulissante con barra inferiore*

**RABAIS / RABATT / SCONTO : 20% dès/ab/da 100.-- (CHF) / 25% dès/ab/da 500.-- (CHF)**  
RABAIS DE QUANTITE SUR DEMANDE ! MENGENRABATT AUF ANFRAGE ! SCONTO DI QUANTITA SU RICHIESTA !



**POULIES POUR CÂBLES - GALETS DE PORTES**

AVEC GORGE RONDE, GORGE CARRÉ OU GORGE EN V  
 AVEC PALIER LISSE, ROULEMENT À ROULEAUX OU À BILLES

**DRAHTSEILROLLEN - SCHIEBETORROLLEN**

MIT RUNDER RILLE, KANTIGER RILLE ODER V-RILLE  
 MIT GLEITLAGER, ROLLENLAGER ODER KUGELLAGER

**PULEGGE PER CAVI - RULLI DI PORTE**

A CANALE TONDO, A CANALE QUADRO O A CANALE IN V  
 A FORO LISCIO, SU CUSCINETTO A RULLI E A SFERE

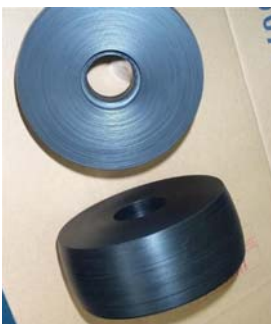
**SPECIALITÉS - SUR MESURE****SPEZIALITÄTEN - NACH MASS****SPECIALITÀ - SU MISURA**









**ROUES ET ROULETTES POUR HÔPITAUX**  
*RÄDER UND ROLLEN FÜR SPITÄLER*  
*RUOTE E ROTELLE PER OSPEDALI*



**ROUES ET ROULETTES POUR L'ALIMENTATION**  
*RÄDER UND ROLLEN FÜR LEBENSMITTEL*  
*RUOTE E ROTELLE PER L'ALIMENTAZIONE*



**ROUES ET ROULETTES POUR MOBILIER**  
*RÄDER UND ROLLEN FÜR MOEBEL*  
*RUOTE E ROTELLE PER MOBILI*



**ROUES ET ROULETTES POUR INDUSTRIES**  
*RÄDER UND ROLLEN FÜR INDUSTRIE*  
*RUOTE E ROTELLE PER INDUSTRIE*



**ROUES ET ROULETTES SUR MESURE**  
*RÄDER UND ROLLEN NACH MASS*  
*RUOTE E ROTELLE SU MISURA*



**ROUES ET ROULETTES POUR FESTIVITÉS**  
*RÄDER UND ROLLEN FÜR FESTLICHKEITEN*  
*RUOTE E ROTELLE PER FESTIVITÀ*



**ROUES ET ROULETTES POUR MAGASINS**  
*RÄDER UND ROLLEN FÜR WARENHAUSER*  
*RUOTE E ROTELLE PER COMMERCIO*



**ROUES ET ROULETTES POUR CONTAINERS**  
*RÄDER UND ROLLEN FÜR CONTAINER*  
*RUOTE E ROTELLE PER CASSONETTI*



**ROUES ET ROULETTES POUR TRANSPORTS**  
*RÄDER UND ROLLEN FÜR TRANSPORT*  
*RUOTE E ROTELLE PER TRASPORTO*

**WEMAS Sàrl - GRAND-RUE 73-75 – CH-2720 TRAMELAN**

Tél. +41 032 487 43 28 - Fax +41 032 487 44 43 - [www.wemas.ch](http://www.wemas.ch)